

AL-2A 230V
AL-1A 120V
AL-9A 100V
AUTO-FEED STATION
 FROM SERIE 233298

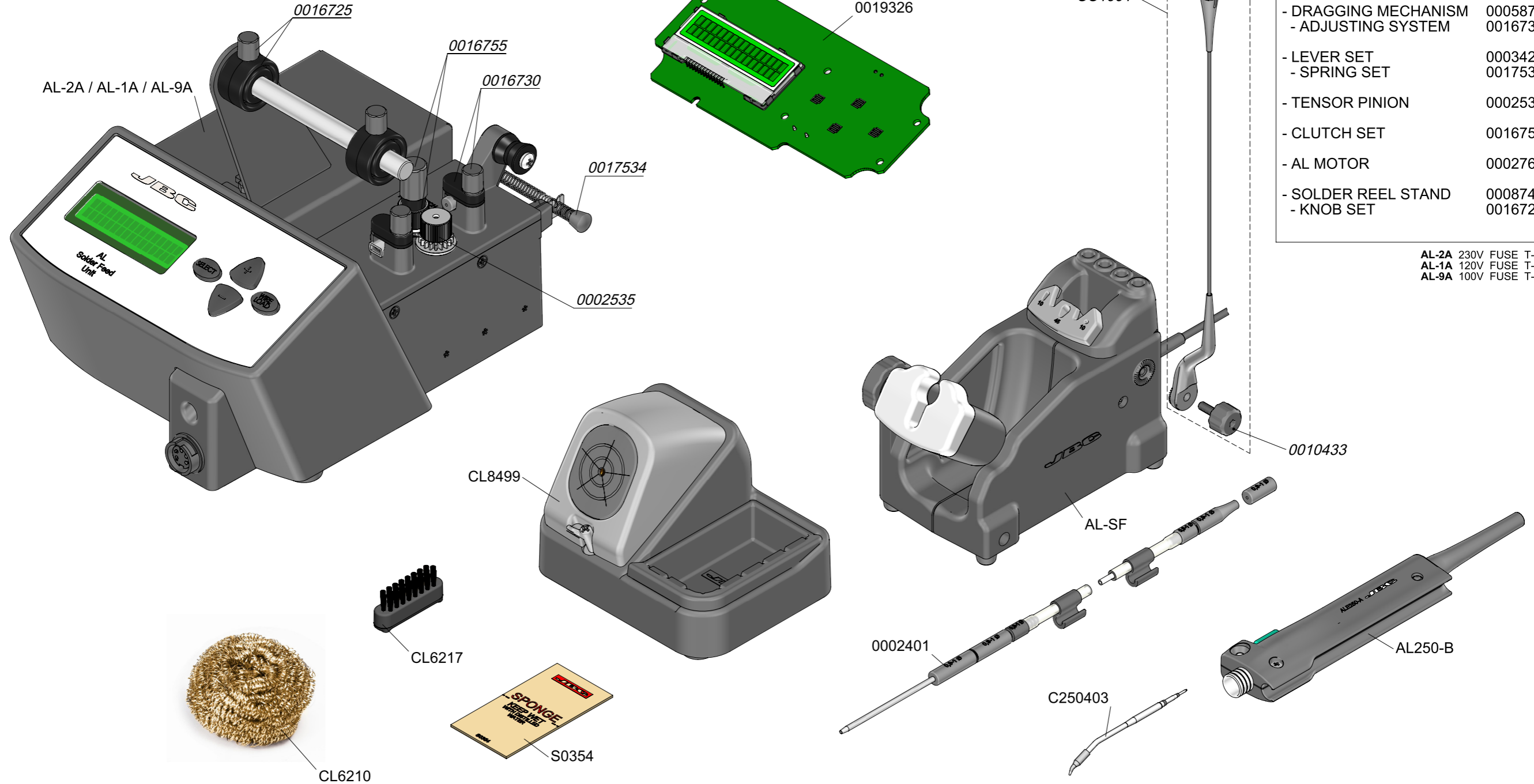

SPARE PARTS	
AL-2A / AL-1A / AL-9A:	
- FRONT CIRCUIT	0019326
- FRONT ENCLOSURE	0008919
- DRAGGING MECHANISM	0005876
- ADJUSTING SYSTEM	0016730
- LEVER SET	0003422
- SPRING SET	0017534
- TENSOR PINION	0002535
- CLUTCH SET	0016755
- AL MOTOR	0002765
- SOLDER REEL STAND	0008745
- KNOB SET	0016725

AL-2A 230V FUSE T-1A
AL-1A 120V FUSE T-2A
AL-9A 100V FUSE T-2A