

JBC

www.jbctools.com

INSTRUCTION MANUAL



JTSE

Power Hot Air Control Unit

This manual corresponds to the following references:

JTSE-9UA (100 V)

JTSE-1UA (120 V)

JTSE-2UA (230 V)

Packing List

The following items are included:



Power Hot Air Control Unit 1 unit

Power cable 1 unit

Ref. 0024099 (100V)

0023715 (120V)

0023714 (230V)

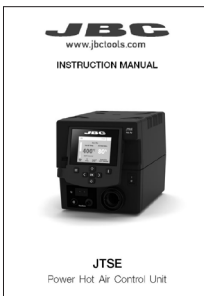

Manual1 unit

Ref. 0027698

Other languages available at www.jbctools.com.

Features and Connections

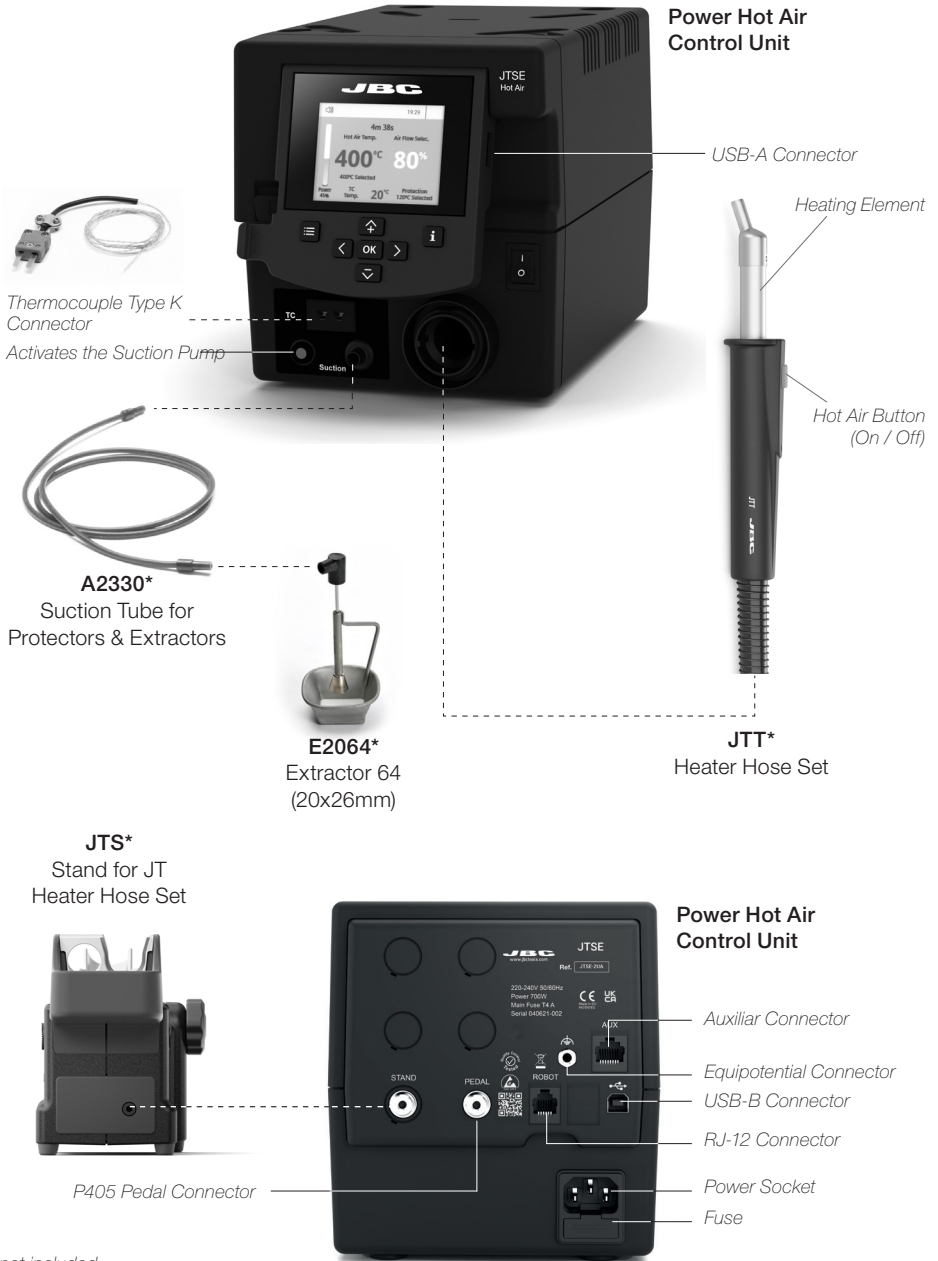

* not included

JTSE / TESE Work Screen

The work screen offers an **intuitive user interface** which provides **quick access** to station parameters. **Default PIN: 0105**

The screenshot shows the JBC work screen with the following data and labels:

- Status Bar:** Includes a speaker icon, the time 19:29, and a 'Time to Stop' indicator of 4m 38s.
- Instant Power Supplied to Heater:** Represented by a vertical bar graph.
- Current Air Temp.:** Displayed as 400°C.
- Selected Air Temp.:** Displayed as 400°C Selected.
- Current External TC Temp.:** Displayed as 20°C.
- Selected External TC Temp.:** Displayed as 120°C Selected.
- Air Flow:** Displayed as 80%.
- Air Flow Selection:** Displayed as Air Flow Selec.
- Protection:** Displayed as Protection 120°C Selected.
- Power:** Displayed as Power 45%.

The navigation keypad consists of the following buttons:

- Up arrow
- Down arrow
- Left arrow
- Right arrow
- OK button
- Information icon (i)
- Menu icon (three horizontal lines)

Menu Options

	<p>Set the station parameters</p>		<p>Set the tool parameters</p>		<p>Display the hours worked in each cycle</p>
<p>Station</p>		<p>Tools</p>		<p>Counters</p>	
	<p>It is possible to choose the language from a list.</p>		<p>Allows you to carry out an overall station reset restoring all the parameters to their default values.</p>		
<p>Language</p>		<p>Reset</p>			

Troubleshooting

Station troubleshooting available on the product page at www.jbctools.com

Advanced Functionalities



Profiles

To work with profiles it is essential to use RWB / RWS / RWT rework arms. The Rework Arms supports the Hot Air Heater maintaining the distance and position to the component.

In this mode you can **set up or edit** as many as 25 air flow and temperature profiles.

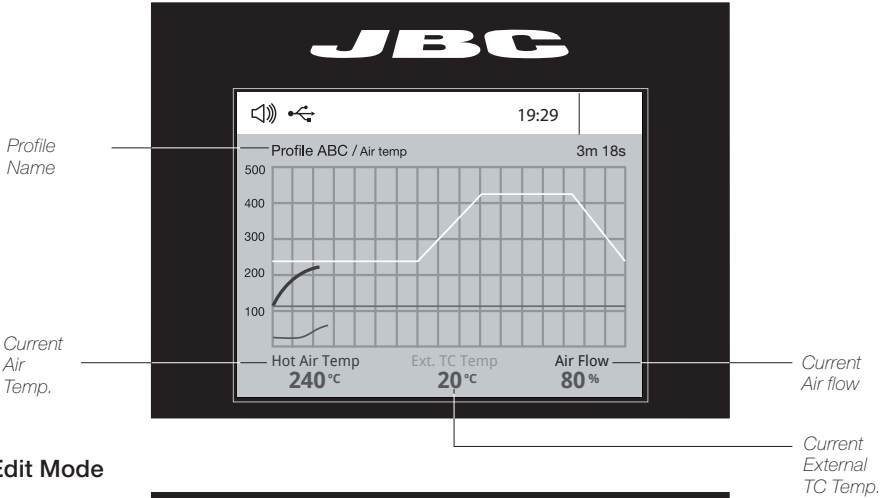

Edit Mode

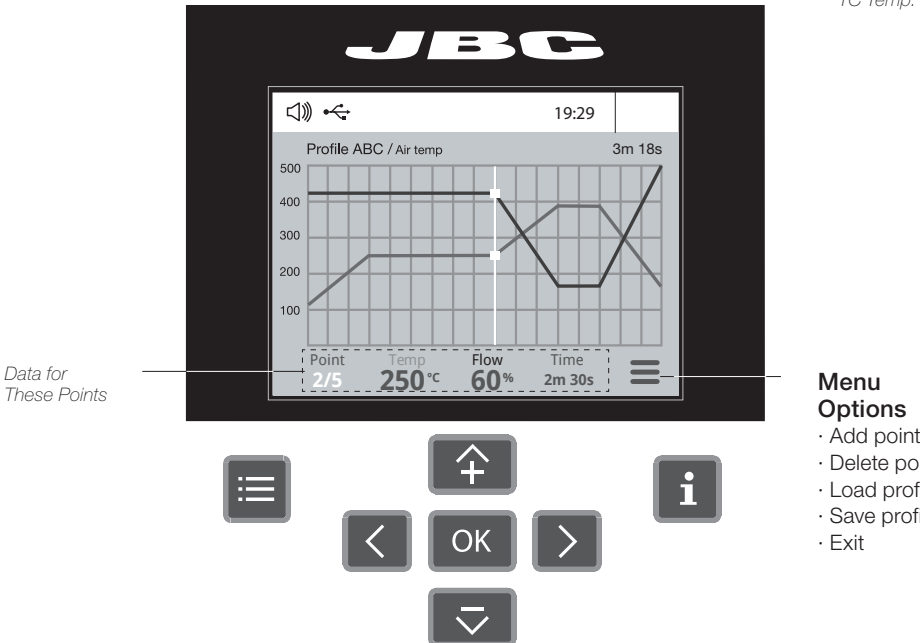



By pressing **Graphics** in the main MENU, temperature and power figures in real time are displayed. This helps you decide which nozzle to use to obtain the best quality solder joints.

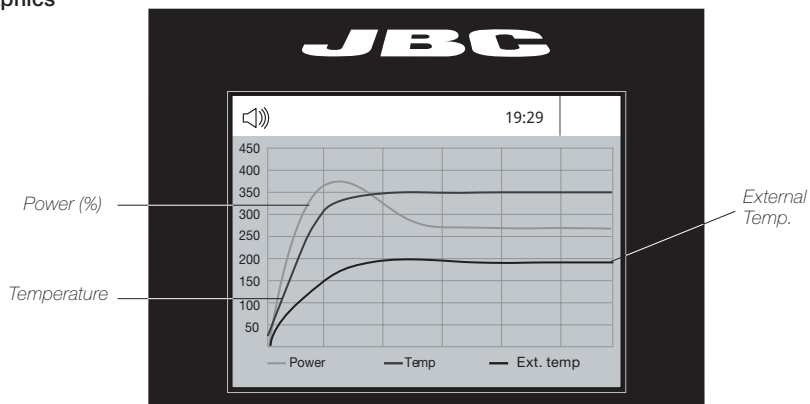

Files

Export Graphics

Insert a USB flash drive into the USB-A connector to save your soldering process in csv format.



Update

Station Update

Download the JBC Update File from www.jbctools.com/software.html Insert the USB flash drive with the file downloaded to the station.

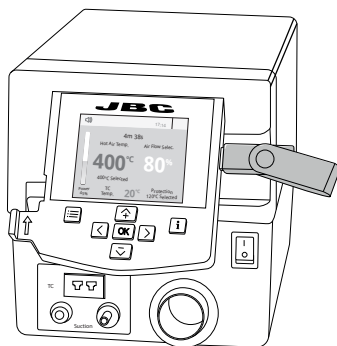

System Notifications

The following icons will be displayed on the screen's status bar.



USB flash drive is connected.



Station software update.
Press INFO to start the process.



Station is controlled by a PC.



Warning.
Press INFO for failure description.



Station is controlled by a robot.



Error.
Press INFO for failure description, the type of error and how to proceed.

Adjustable Tool Holder

Adjust the tool holder angle to suit your work position.

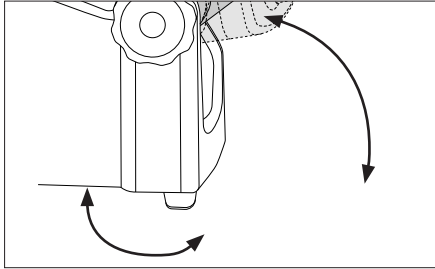

Operation Modes

1. From the Tool Settings Menu, select the mode to activate the tool depending on the task.

Tool button

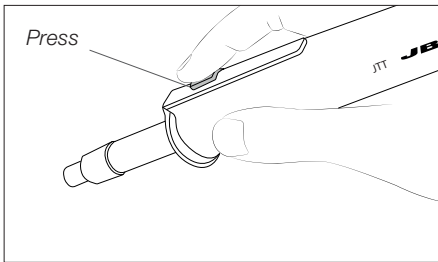

Press the start/stop button to blow hot air.

Pedal (not included)

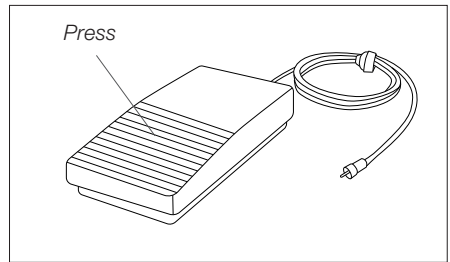

Press the Pedal P405 to blow hot air and release it to stop.

2. The tool stops blowing when pressing the start/stop button.

If the stand is connected to the station and for safety reasons, it will also stop when returned to the stand.

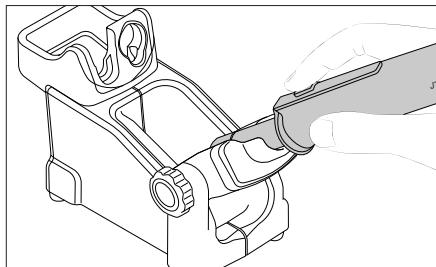

Operation

1. Placing

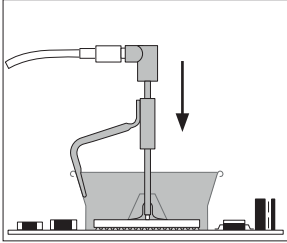

Position the extractor with the appropriate suction cup and press the suction button.

2. Heating

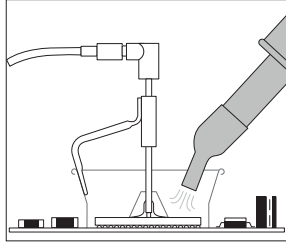

Heat the component.

3. Extracting

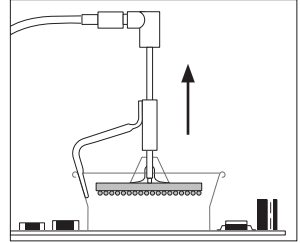

The component lifts off automatically when the solder melts.

Protectors & Extractors

For small components (fig. 1 and 2).

We recommend using the protector + tripod

For large components (fig. 3 and 4).

We recommend using the manual extractors

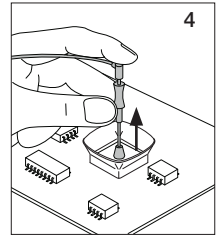
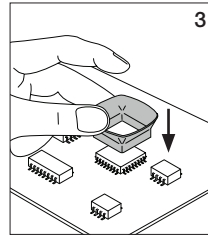
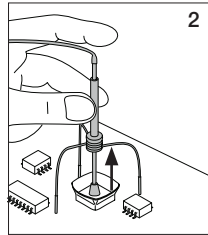
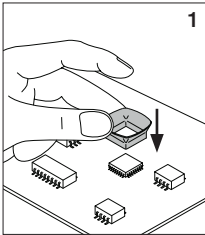

Accessories *(not included)*

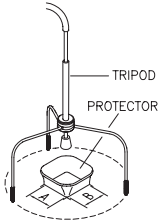

Protectors

No.*	Ref.	AxB (mm)	AxB (in)	No.*	Ref.	AxB (mm)	AxB (in)
	P3353	4,3 x 3	0.16 x 0.12		P1249	12 x 23	0.47 x 0.9
	P3786	5,2 x 5,2	0.20 x 0.20	44	P4000	12,5 x 12,5	0.49 x 0.49
	P3352	5,2 x 7,5	0.20 x 0.29		P3354	13,2 x 13,2	0.52 x 0.52
	P3355	5,2 x 9,5	0.20 x 0.37		P4025	13,5 x 21,5	0.53 x 0.85
	P3356	6,2 x 4,2	0.24 x 0.16	48	P2230	15 x 15	0.59 x 0.59
	P3785	7,2 x 7,2	0.28 x 0.28	60	P4010	17 x 17	0.67 x 0.67
	P3784	8,2 x 8,2	0.32 x 0.32		P4005	18 x 29	0.71 x 1.14
	P4035	9 x 13	0.35 x 0.51		P4030	18,5 x 18,5	0.73 x 0.73
	P4040	9,5 x 19	0.7 x 0.74		P1068	18,5 x 24	0.73 x 0.94
	P4080	9,5 x 21	9.5 x 0.83		P2685	28,5 x 28,5	1.12 x 1.12
32	P2220	10 x 10	0.39 x 0.39		P4085	31,5 x 31,5	1.24 x 1.24
	P4045	10,5 x 21	0.14 x 0.82		P2672	33 x 46	1.30 x 1.18
	P4090	11 x 16	0.43 x 0.63		P4002	50 x 50	1.97 x 1.97
24	P2235	12 x 17	0.47 x 0.67		P3357	52,5 x 14	2.06 x 0.55

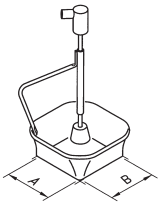

Extractors

No.*	Ref.	AxB (mm)	AxB (in)	No.*	Ref.	AxB (mm)	AxB (in)
52	E2052	20 X 20	0.79 x 0.79		E4015	31,5 X 31,5	1.24 x 1.24
64	E2064	20 X 26	0.79 x 1.02		E2084	33 X 33	1.30 x 1.30
80	E2184	24 X 24	0.94 x 0.94		E2100	38 X 38	1.50 x 1.50
	E2068	27 X 27	1.06 x 1.06		E2124	45 X 45	1.77 x 1.77
	E4020	28,5 X 28,5	1.12 x 1.12				

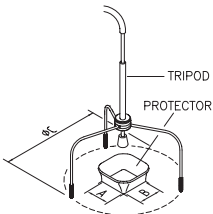

Tripods

Ref.	øC (mm)	øC (in)
T2050	39	1.53
T2250	85	3.35



Manual extractor

Ref.	øD (mm)	øD (in)
E2190	7	0.27

* Position in Extractor Stand

Using the Thermocouple Type K

Connect a TC type K (PH218) to the station and use it as a protection or regulation sensor. You can define its use mode by means of the “Ext TC mode” option in the “Tool” menu.

You can choose from **two work modes**:

Regulation: the station regulates the air the temperature automatically to maintain the External Thermocouple (TC) temperature.

Protection: the station cuts the air supply off when the External Thermocouple (TC) temperature is reached.

Fix the TC with Kapton Tape (Ref. PH217) as near as possible to the component being worked on. If Kapton tape is not ESD you must use an ionizer.

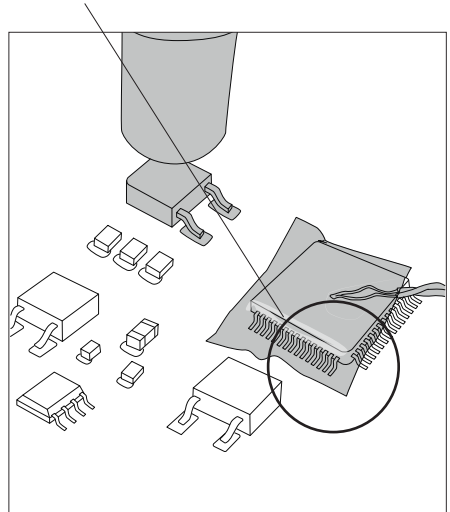
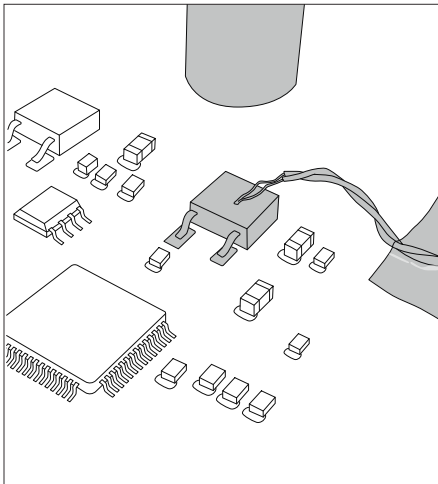

It is not recommended to exceed ramp-up rates over 3-4 °C / sec. (5-7 °F / sec) so as to reduce the risk of thermal stress on the PCB.

Nozzle Exchanger

⚠ Turn the tool off and handle with care. The heating element and the nozzle are still hot.

1. Removing Nozzle

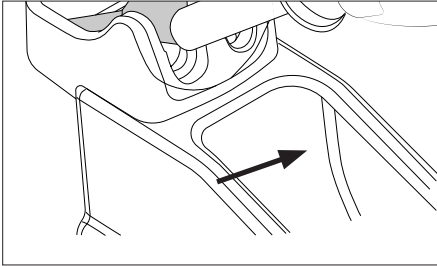

Place the heating element with its nozzle in the nozzle changer and pull the tool to remove it. The nozzle comes to rest in the nozzle holder.

2. Attaching Nozzle

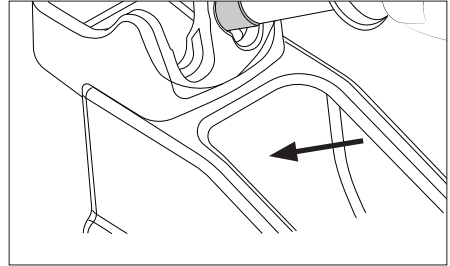

Attach the nozzle and press the nozzle onto the heating element with the help of the opening in the nozzle exchanger.

Compatible Nozzles

JTT works with JN nozzles. Find the model that best suits your soldering needs at www.jbctools.com

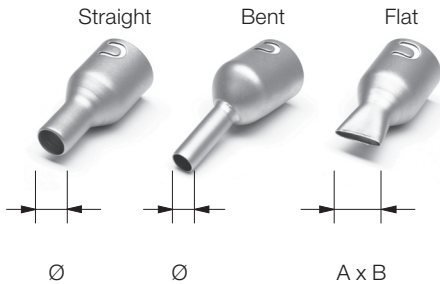

In case of a loosely fitting nozzle:

1. Push the nozzle tab inwards with a screwdriver or flat-nosed pliers.

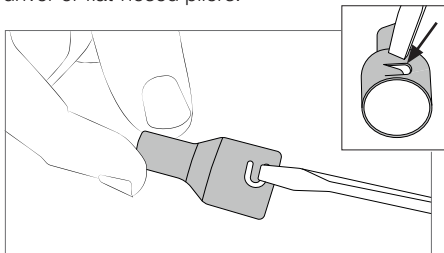

2. Assemble the nozzle onto JTT again.

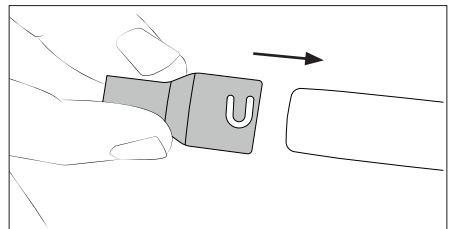

*	Ref.	Shape	Size (mm)	Size (in)
*	JN2020	Straight	Ø 8	Ø 0.31
	JN8417	Straight	Ø 10	Ø 0.4
*	JN2015	Bent	Ø 4	Ø 0.16
*	JN2012	Bent	Ø 6	Ø 0.24
	JN6633	Bent	Ø 8	Ø 0.31
	JN7637	Flat	10 x 2	0.39 x 0.08
	JN7638	Flat	20 x 2	0.79 x 0.08
	JN7639	Flat	30 x 2	1.18 x 0.08

* Supplied with JTSE Station

Replacing the Heating Element

Note: Only perform this operation when the element is cold and the unit is disconnected from the mains.

Loosen the screw (1) and pull the worn heating element out of the handle (2).

Insert the new heating element, make sure its pushed all the way in (2) and tighten the screw (1).

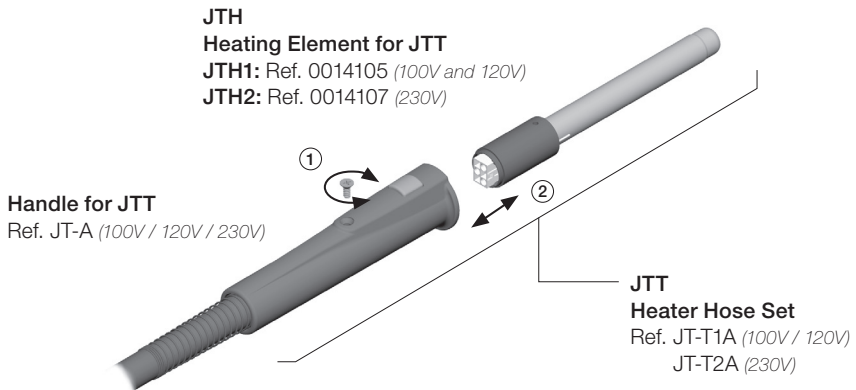

Changing the JTT Heater Hose Set

Note: Only perform this operation when the station is turned off.

Use a spanner to unscrew the nut (1) and remove the tool hose from the control unit (2).

Insert the new hose, make sure it is pushed all the way into the connector (2), and tighten the nut (1).

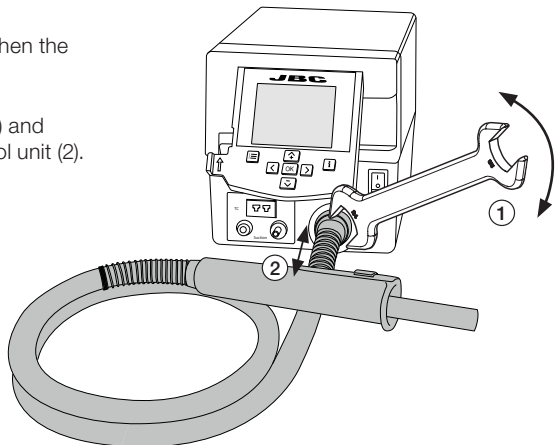

Maintenance

Before carrying out maintenance, always allow the equipment to cool.

- Clean the station screen with a glass cleaner or a damp cloth.
- Use a damp cloth to clean the casing and the tool. Alcohol can only be used to clean the metal parts.
- Periodically check that the metal parts of the tool and stand are clean so that the station can detect the tool's status.
- Periodically check all cables and tubes.
- Replace a blown fuse as follows:



1. Pull off the fuse holder and remove the fuse. If necessary use a tool to lever it off.

2. Insert the new fuse into the fuse holder and return it to the station.

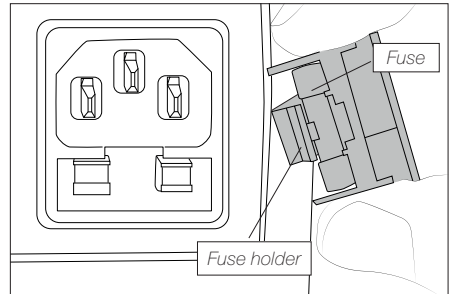
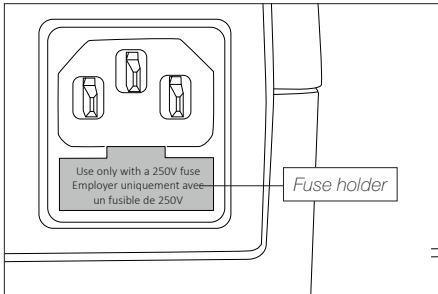

- Replace any defective or damaged pieces. Use original JBC spare parts only.
- Repairs should only be performed by a JBC authorized technical service.

Safety



It is imperative to follow safety guidelines to prevent electric shock, injury, fire or explosion.

- Do not use the units for any purpose other than soldering or rework. Incorrect use may cause a fire.
- The power cord must be plugged into approved bases. Be sure that it is properly grounded before use. When unplugging it, hold the plug, not the wire.
- Do not work on electrically live parts.
- The tool should be placed in the stand when not in use in order to activate the sleep mode. The soldering tip or nozzle, the metal part of the tool and the stand may still be hot even when the station is turned off. Handle with care, including when adjusting the stand position.
- Do not leave the appliance unattended when it is on.
- Do not cover the ventilation grills. Heat can cause inflammable products to ignite.
- Avoid flux coming into contact with skin or eyes to prevent irritation.
- Be careful with the fumes produced when soldering.
- Keep your workplace clean and tidy. Wear appropriate protection glasses and gloves when working to avoid personal harm.
- Utmost care must be taken with liquid tin waste which can cause burns.
- This appliance can be used by children over the age of eight and also people with reduced physical, sensory or mental capabilities or lack of experience provided that they have been given adequate supervision or instruction concerning the use of the appliance and understand the hazards involved. Children must not play with the appliance.
- Maintenance must not be carried out by children unless supervised.

Specifications

JTSE

Power Hot Air Control Unit

Ref.: **JTSE-9UA** 100V 50/60Hz. Input fuse T8A. Rated current 7A.

Ref.: **JTSE-1UA** 120V 50/60Hz. Input fuse: T8A. Rated current: 7A

Ref.: **JTSE-2UA** 230V 50/60Hz. Input fuse: T4A. Rated current: 3A

- Nominal Power: 700W
- Selectable Temperature: 150 - 450 °C / 300 - 840 °F / Room temp.
- Cool Mode: T off. Used to blow air to room temperature
- Ambient Operating Temp.: 10 - 50 °C / 50 - 122 °F
- Air Flow Regulation: 5 - 50 SLPM
- Vacuum: 30% / 228 mmHg / 9 inHg
- Connectors: USB-B
RJ-12
P-005 Pedal
- Control Unit Dimensions/Weight:
(L x W x H) 1.90 kg / 4.2 lb
230 x 148 x 160 mm / 5.83 x 7.24 x 5.51 in
- Total Package Dimensions/Weight:
(L x W x H) 258 x 328 x 208 mm / 2.56 kg
10.15 x 12.9 x 8.2 in / 5.64 lb

Complies with CE standards.
ESD safe.

JBC

Warranty

JBC's 2 year warranty covers this equipment against all manufacturing defects, including the replacement of defective parts and labour.

Warranty does not cover product wear or misuse.

In order for the warranty to be valid, equipment must be returned, postage paid, to the dealer where it was purchased.

Get 1 extra year JBC warranty by registering here:
<https://www.jbctools.com/productregistration/>
within 30 days of purchase.



This product should not be thrown in the garbage.

In accordance with the European directive 2012/19/EU, electronic equipment at the end of its life must be collected and returned to an authorized recycling facility.

CE EAC UK
CA

www.jbctools.com

0027698-161023