

JBC

www.jbctools.com

INSTRUCTION MANUAL



CS

Precision Desoldering Station

This manual corresponds to the following references:

- CS-9F (100V)
- CS-1F (120V)
- CS-2F (230V)

Packing List

The following items are included:



CS Control Unit 1 unit

Micro Desoldering Iron 1 unit

Ref. DS360-A

C360004 already inserted



Power Cord1 unit

Ref. 0024092 (100V)

0023715 (120V)

0023714 (230V)

Sponge 1 unit

Ref. S0354

Brass Wool1 unit

Ref. CL6210

DS360 Accessories 1 unit
Ref. 0010259



C360 Tips 10 units
Ref. C360002 (x5)
C360004 (x5)



Filter 2 units
Ref. 0008048



Cleaning Brush 1 unit
Ref. 0008297



Solder Collector 2 units
Ref. 0008467



Cleaning Rods 1 unit
Ref. 0008466



**Electric Desoldering
Module for DI & CS** 1 unit
Ref. MS-A



Filter Set 1 unit
Ref. 0005966
It contains 50 filters



Cotton Filter Set 1 unit
Ref. 0781046
It contains 10 filters



Suction Filter 1 unit
Ref. 0821830



Module Cable 1 unit
Ref. 0026830

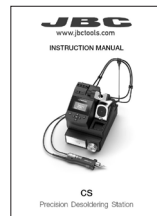

Manual 1 unit
Ref. 0026947

Features and Connections

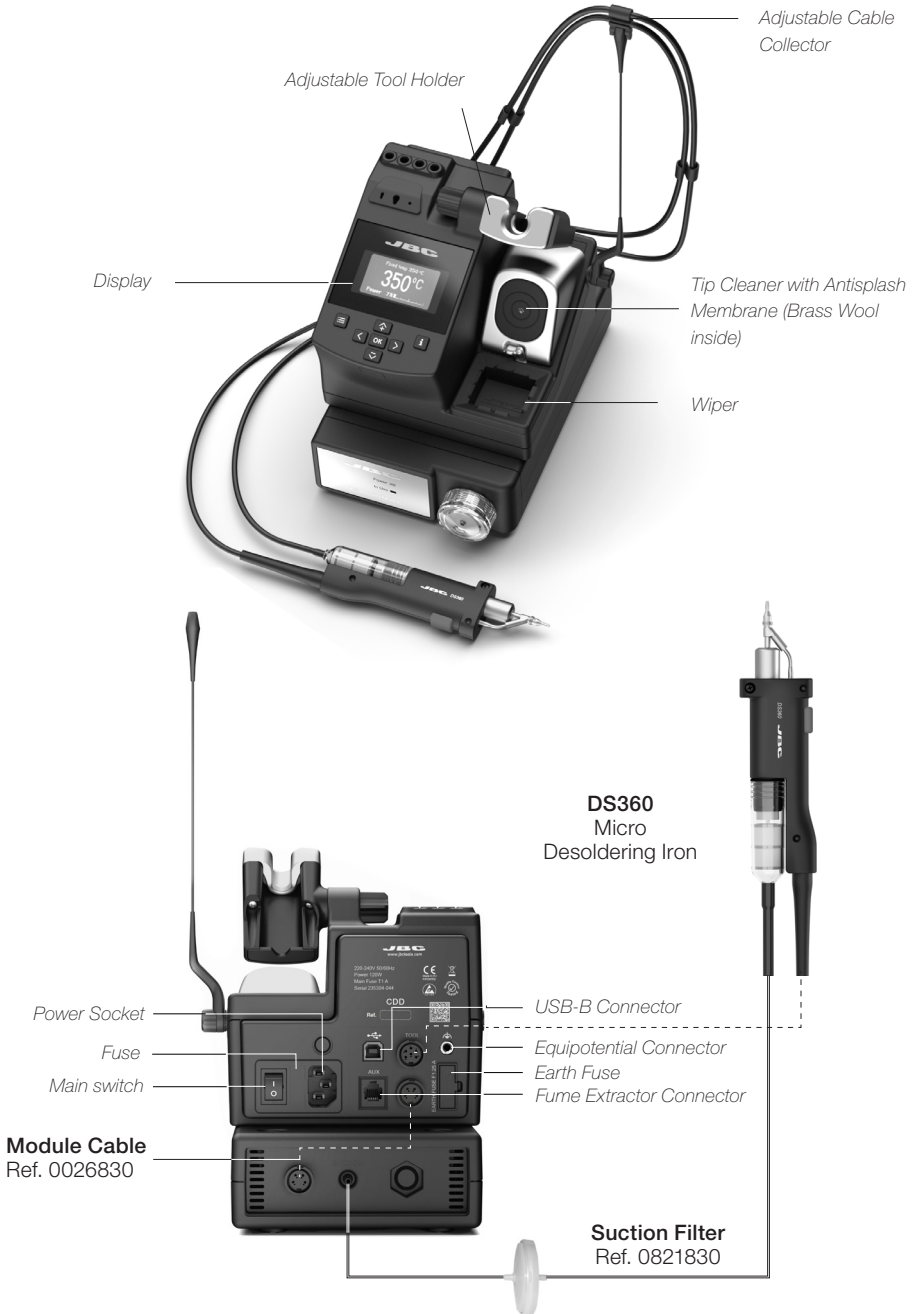

Adjust. Tool Holder Cable Collector

The position of the tool holder (ref. **0014720**) can be easily adjusted by loosening or tightening the knob.

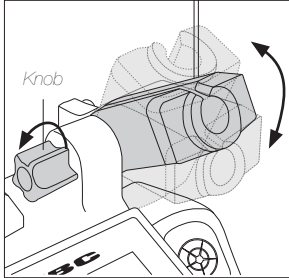

The metal top detects the tool and activates Sleep & Hibernation modes.

The cable collector (ref. **CC1001**) keeps the cable away from the work area and prevents the weight of the cable from disturbing the operator while soldering.

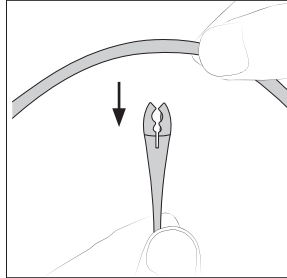

Insert the cable into the cable collector clip. Do not leave the cable longer than necessary to reach the work area freely.

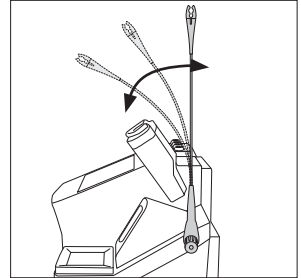

The cable collector is flexible. It accompanies and adapts to the movements during the soldering process.

Tip Cleaner

Select the option to suit your needs and improve the thermal transfer of the tip.

Splashguard

Ref. 0017576

Prevents the splashing of solder and wool particles

Antisplash Membrane

Ref. CL7882

Prevents splashing and keeps the work area clean.

Brass Wool

Ref. CL6210

Very effective cleaning method. Leaves a small layer of solder on the tip preventing oxidation between cleaning and reflowing.

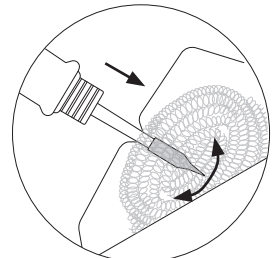
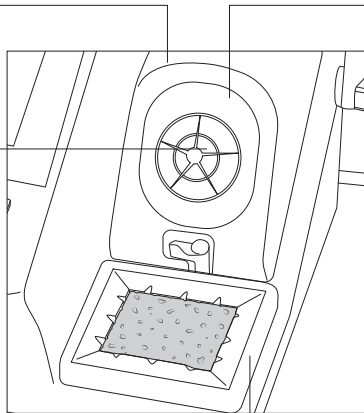

If the tip is dirty, JBC recommends first cleaning it with the wiper to remove excess solder.

Wiper

Ref. CL7984

A temperature-resistant receptacle for removing excess solder by gently tapping or wiping.

Wool/Brush Replacement

1. Unlock the splashguard.

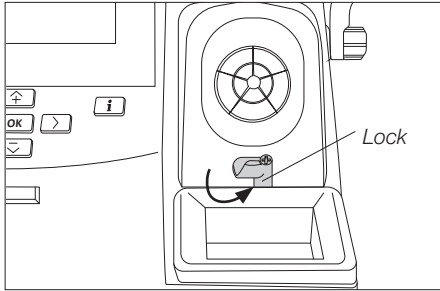

2. Lift off the splashguard and change the worn brasswool/brush for a new one.

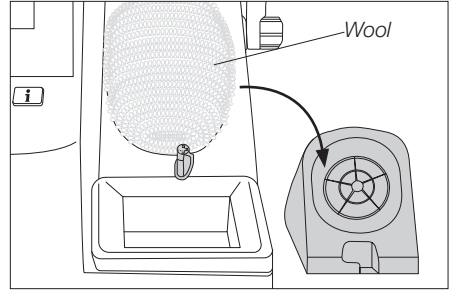

More cleaning options:

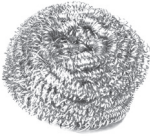

Inox Wool*
Ref. CL6205
Stronger cleaning method than brass wool.

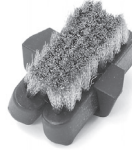

Metal Brush*
Ref. CL6220
When used carefully, it provides more thorough cleaning.

Wiper

Ref. CL7984

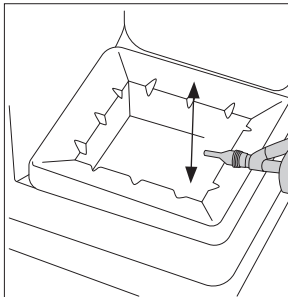

Tapping:

Tap gently to remove excess solder.

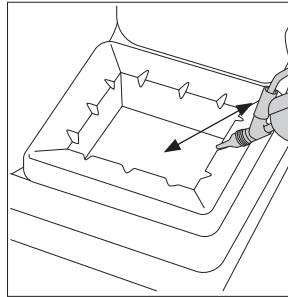

Wiping:

Use the slots to remove the remaining particles.

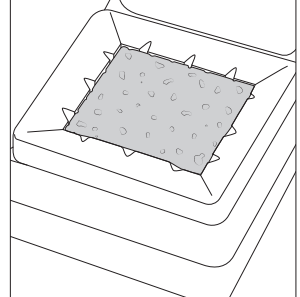

Sponge

Ref. S0354

The softest cleaning method. Keep the sponge damp with distilled water when working to avoid tip wear.

* not included, sold separately

Tip Care

To prevent tip oxidation cover the tip with solder tin when not in use.

⚠ Note: Do not press the vacuum pump button while tinning the desoldering tip, as the fumes given off by the flux would quickly block the ducts and the air filter.

Changing Tips

⚠ Note: This operation should be carried out while the tip is hot and at a minimum temperature of 250°C so that any tin left inside is still molten.

1. To remove the tip, use a pair of flat-nosed pliers, twist the tip and pull.

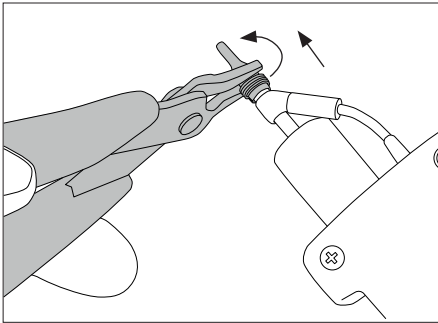

2. To fasten the tip, do not hold it on the spring clamp. Place the pliers directly in front of the spring.

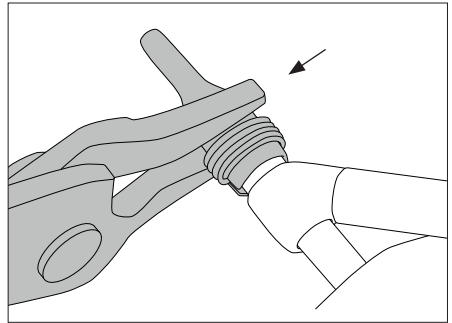

Cleaning Tips

The tip hole should be periodically cleaned.

⚠ Note: Let the tool cool down before performing this operation.

Choose the cleaning rod diameter according to the tip size. Put the rod at the tip and gently move it back and forth while turning it slightly.

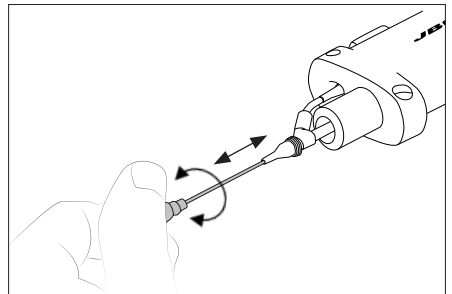

Compatible Tips

The CS station works with C360 tips and DS360 irons.
Find the model that best suits your needs at www.jbctools.com

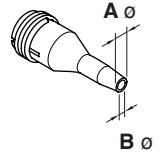

Through-Hole Desoldering Tips



C360001

ØA= 1 mm (0.04 in)
ØB= 0,6 mm (0.02 in)
Ømax. pin= 0,4 mm (0.02 in)



C360002

ØA= 1,2 mm (0.05 in)
ØB= 0,8 mm (0.03 in)
Ømax. pin= 0,6 mm (0.02 in)



C360003

ØA= 1,4 mm (0.06 in)
ØB= 1 mm (0.04 in)
Ømax. pin= 0,8 mm (0.03 in)



C360004

ØA= 1,6 mm (0.06 in)
ØB= 1,2 mm (0.05 in)
Ømax. pin= 1 mm (0.04 in)



C360007

ØA= 1,9 mm (0.08 in)
ØB= 1,4 mm (0.06 in)
Ømax. pin= 1,2 mm (0.05 in)



C360006

ØA= 3 mm (0.12 in)
ØB= 1,5 mm (0.06 in)
Ømax. pin= 1,3 mm (0.05 in)

Pad Cleaning Tips



C360011

ØA= 1 mm (0.04 in)
ØB= 0,6 mm (0.02 in)



C360012

ØA= 1,3 mm (0.05 in)
ØB= 0,8 mm (0.03 in)



C360013

ØA= 1,4 mm (0.06 in)
ØB= 1 mm (0.04 in)



C360014

ØA= 1,6 mm (0.06 in)
ØB= 1,2 mm (0.05 in)

Desoldering Process

When desoldering, use a tip with a diameter larger than the pad being desoldered. This will achieve maximum suction and thermal efficiency.

Place the tip with the component terminal in the hole.

1. Placing

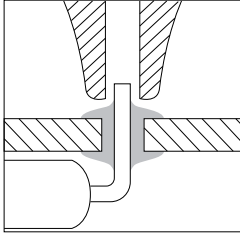

Place the tip with the component terminal in the hole.

2. Circular movement

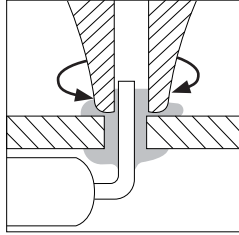

When the solder joint liquifies gently describe circles around the pin. Using the pin as the center of your movement.

3. Aspirating

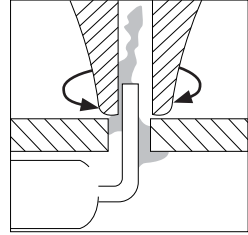

Press the vacuum pump button long enough to remove the solder.

The vacuum pump will continue to run for a few seconds. This makes sure that the vacuum circuit is completely empty. If there is any solder remains left on a terminal, just resolder it with fresh solder and repeat the desoldering operation.

Desoldering Iron Maintenance

⚠ Note: For the following operations, turn off the station or disconnect the tool and wait until the tool temperature drops to room temperature.

Changing the Heating Element

1. Remove the filter before changing the heating element.

2. Remove the set screw and take out the heating element.

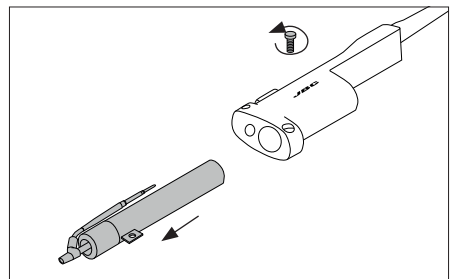
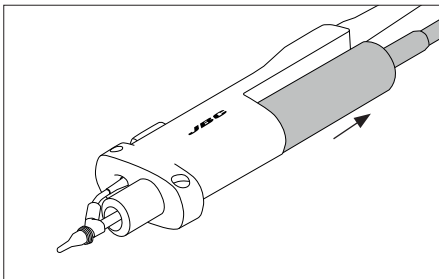

3. Insert the new heating element into the tool.

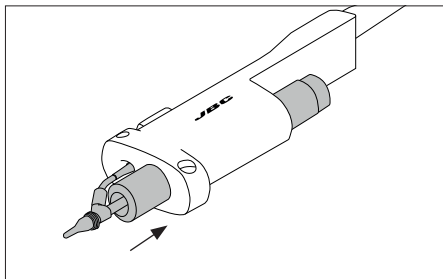

4. Tighten the set screw and insert the filter.

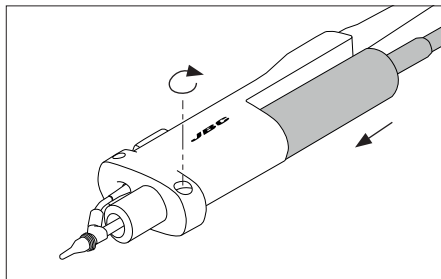

Changing the Iron Filter

1. Remove the tube from the filter.

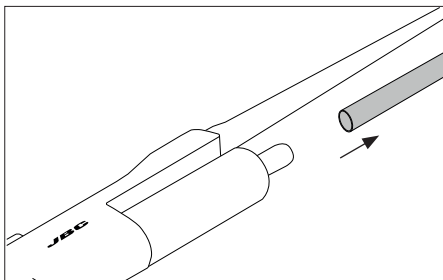

2. Remove the filter from the tool.

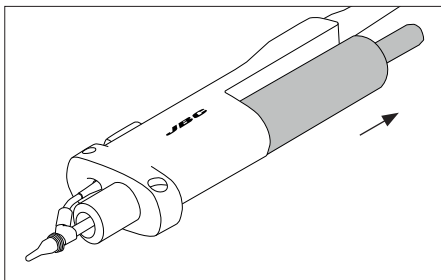

3. Insert a new filter (ref. 0008473) into the tool and mount the tube onto the filter.

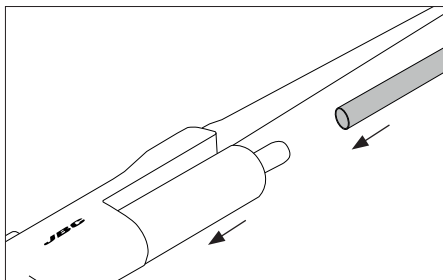

Cleaning the Solder Collector

⚠ Note: For this operation, turn off the station or disconnect the tool and wait until the tool temperature drops to room temperature.

1. Remove the filter before cleaning the solder collector.

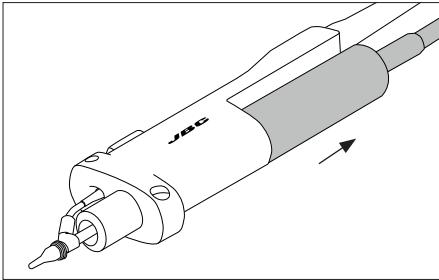

2. Take out the solder collector with the metal solder retention.

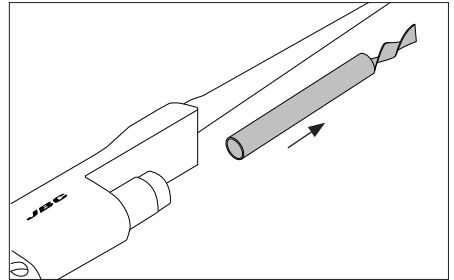

3. Use the cleaning brush (ref. 0008297) to clean the solder collector inside or replace it with a new one.

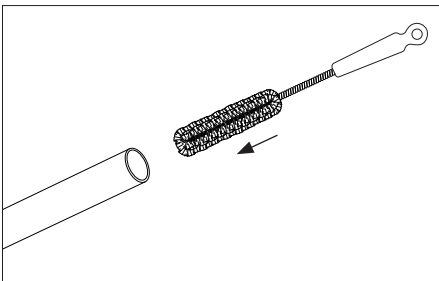

4. Insert the solder collector with the metal solder retention into the heating element.

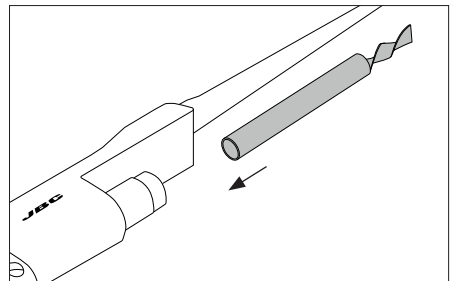

5. Mount the filter onto the tool.

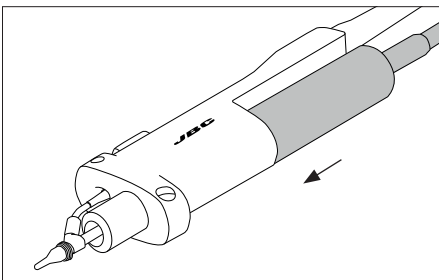

Electric Desoldering Module

⚠ Note: Before carrying out maintenance, always unplug the equipment.

If there is a loss of suction, check that there is no obstruction in the tool (tip, heating element, tool filter), tube or suction filters.

Changing Pump Filters

Periodically check the filters and replace them if they are yellowish.

⚠ Note: Do not use sharp pointed objects to open the suction filter.

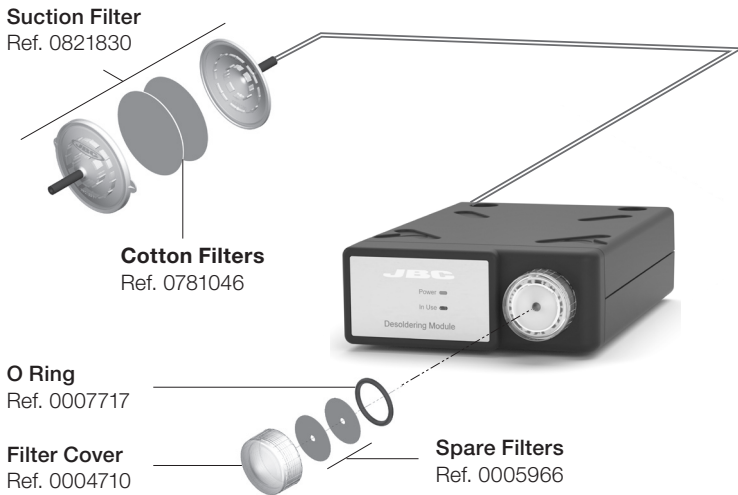

Operation

JBC's Most Efficient Soldering System

This revolutionary technology is able to recover tip temperature extremely quickly. This allows the user to work at a lower temperature. As a result, tip life is five times longer than with other brands.

1. Work

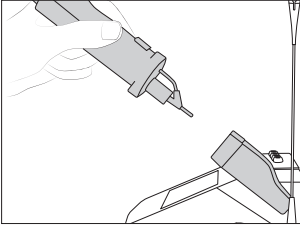

When the tool is lifted from the stand the tip will heat up to the selected temperature.

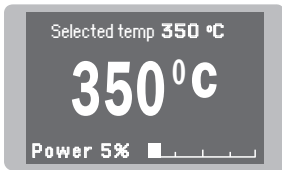

Tool Settings:
· *Operating Temp.*

Select temperature between 90 and 450 °C using:

⬆ or ⬇ (steps of ± 5 °C / °F)
⬅ or ➤ (steps of ± 50 °C / °F)

Tool Settings:
· *Temp. Levels*

Press , select *Tool Settings* and activate the *Temp. Levels* option.

Use  or  (steps of ± 5 °C / °F)

2. Sleep

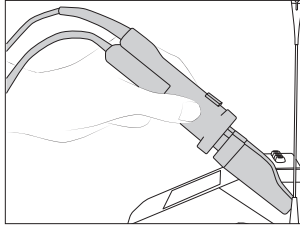

When the tool is in the stand, the temperature falls to the preset sleep temperature.



Tool Settings:
· *Sleep*

Change Sleep temperature and set Sleep delay from 0 to 9 min or no Sleep.

3. Hibernation

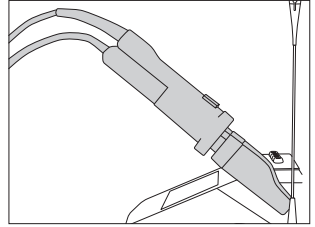

After longer periods of inactivity, the power is cut off and the tool cools down to room temperature.



Tool Settings:
· *Hibernation*

Change Hibernation delay from 0 to 60 min or no Hibernation.

Control Process

Work Display

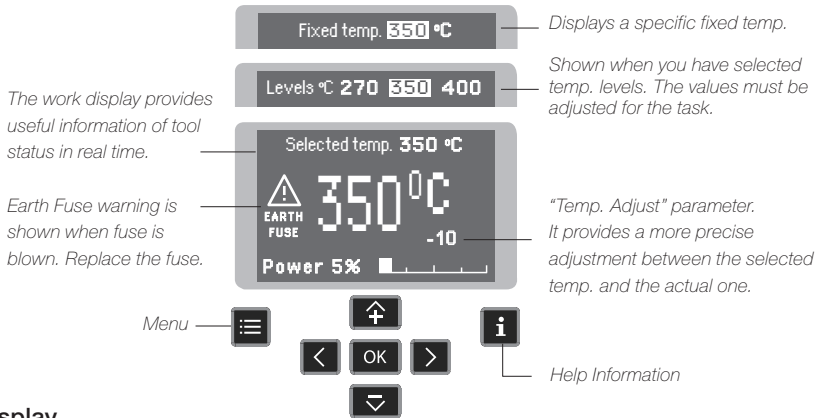

Menu Display

Default PIN: 0105

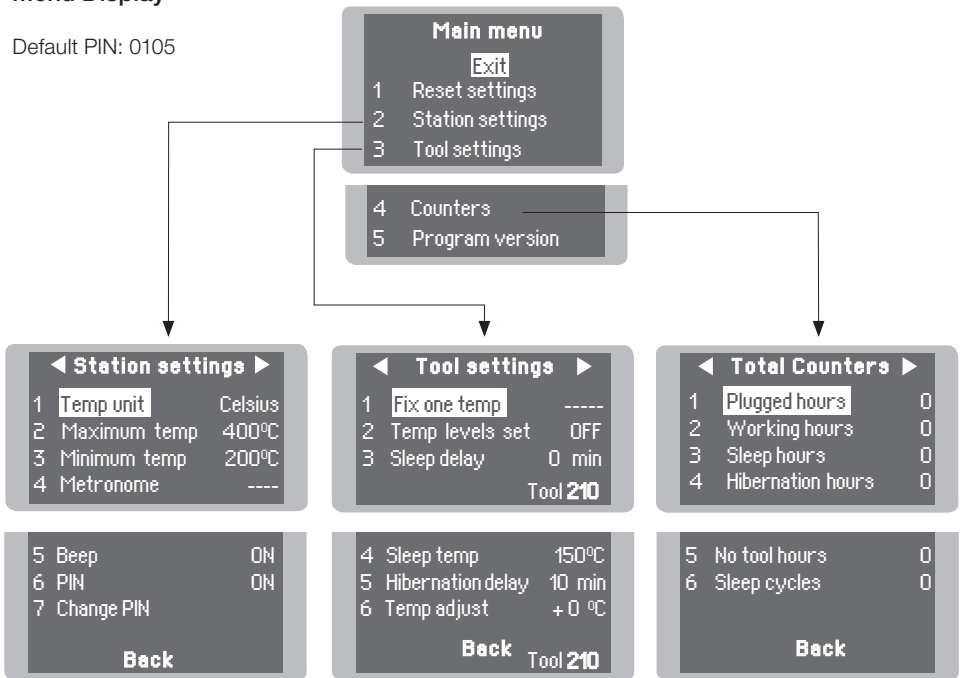

Troubleshooting

Station troubleshooting available on the product page at www.jbctools.com

Parameters

Be careful when using these parameters as they may reduce the tip life if not used properly. Please follow the recommended guidelines:



Station Settings

Parameter Description	Recommendations	Warnings
Temperature Unit Celsius (°C) or Fahrenheit (°F)	N/a	N/a
Maximum Temperature Set the maximum temperature to work with. Default max. temp is 400 °C (750 °F). This is considered high enough to work with most lead-free applications.	The station temperature range is 90-450 °C (190-840 °F). Change the temperature limits when working with less common applications such as low / high melting point soldering (HMP) or plastics (e. g. riveting).	 In most cases, working with temperatures over 400 °C (750 °F) can damage the PCB and its components. Even in short time periods of tip contact with the soldering joint, the flux may not work properly and could seriously reduce tip life. If the solder joint requires more power (e.g. multilayered or high dissipation boards), JBC strongly recommends using other aids like preheaters.
Minimum Temperature Set the minimum temperature to work with. Default min. temp. is 200 °C (392 °F). This is considered to be a proper starting point for leaded applications.		
Metronome This activates a beep sound. Frequencies vary from 1 to 50 seconds.	Useful for setting a work rate in repetitive jobs. The beep lets you know the length of time the tip must be in contact with the soldering joint.	N/a
Beep Enable/disable the beep sound of the keypad.	N/a	N/a
Pin Enable/disable pin prompt.	N/a	N/a
Change Pin Change the default security PIN number (0105).	The PIN must be entered every time a parameter is changed.	N/a

Tool Settings

Parameter Description	Recommendations	Warnings
Fix One Temperature Fix a value within the temperature range of the station (90-450 °C/190-840 °F).	Ideal for soldering more than one component at a specific temperature. The station will reject any attempt to change the temperature.	N/a
Temperature Levels Set Similar to “Fix one temp” parameter. In this case, the user can set up to 3 values for different power requirements.	This allows a quick change between 3 different temperatures. Set them according to the allowed values for your soldering applications.	N/a
Sleep Delay Set the time that the tool will remain at the selected temperature when in the stand before entering Sleep mode. The tip temperature will then drop to the Sleep temperature.	Because our tools reach the working temperature from the default Sleep mode in only a few seconds, this parameter is preset to 0 min. Once the tool is returned to the stand, the temperature will automatically drop to Sleep temperature, extending tip life and avoiding oxidation. Retinning the tip before placing the tool in the stand will protect the tip and extend its life.	 Setting these parameters to higher values will unnecessarily accelerate oxidation and shorten tip life especially when working with temperatures up to 450 °C / 840 °F.
Sleep Temperature This is the set temperature the tip reaches when returned to the stand.	Sleep temperatures are set to achieve a balance between preventing oxidation and reaching the working temperature in a few seconds.	

Tool Settings

Parameter Description	Recommendations	Warnings
<p>Hibernation Delay Set the time the tool will remain at Sleep Temperature before entering in Hibernation Mode. At this time, the power supply is cut off and the tip remains at room temperature.</p>	<p>This function completely protects the tip from oxidation during long periods of inactivity while the tool is in the stand. Retinning the tip before placing the tool in the stand also helps prevent oxidation and extends the life of the tip.</p>	<p> Increasing the default value will accelerate oxidation and shorten the tip life.</p>
<p>Temp Adjustment It provides a more precise adjustment between the selected temperature and the actual one.</p>	<p>Set values within ± 50 °C / ± 90 °F to achieve zero error. JBC strongly recommends the use of TID-A or TIA-A Thermometers to obtain precise readings.</p>	<p> When the user changes the cartridge type, the parameter should be reset to 0 °C/F or to the value needed for this cartridge. E.g. If a correction of +20 °C / +36 °F is set for a thick cartridge and then the user changes to a thinner one without resetting the temperature adjustment, he would be working at a higher temperature than needed for this thinner cartridge, which does not need any temperature adjustment.</p>

USB Connector

Download the latest software from our website to improve your soldering station.

JBC Updater

www.jbctools.com/software.html

Update the station software via USB connection:

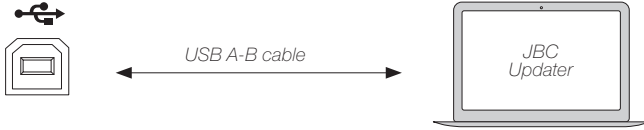

Maintenance

Before carrying out maintenance, always switch the device off and disconnect it from the mains. Allow the equipment to cool down.

- Clean the station display with a glass cleaner or a damp cloth.
- Use a damp cloth to clean the casing and the tool. Alcohol can only be used to clean the metal parts.
- Periodically check that the metal parts of the tool and the tool holder are clean so that the station can detect the tool's status.
- Maintain the tip surface clean and tinned before storage to avoid tip oxidation. Rusty and dirty surfaces reduce heat transfer to the solder joint.
- Periodically check all cables.
- Replace any defective or damaged pieces. Only use original JBC spare parts.
- Repairs should only be performed by a JBC authorized technical service.

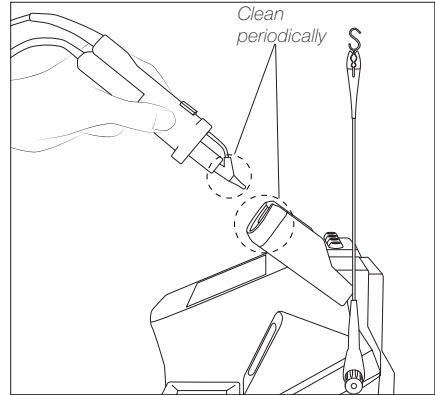

EARTH FUSE

- When this warning appears on the main display, earthing fuse must be replaced.
- Replace a blown fuse as follows (applies to both the earthing fuse and the main fuse):
 1. Pull off the fuse holder and remove the fuse. If necessary, use a tool to lever it off.
 2. Insert the new fuse into the fuse holder and return it to the station.

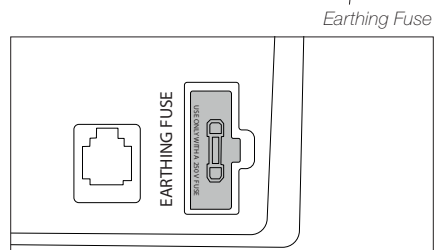
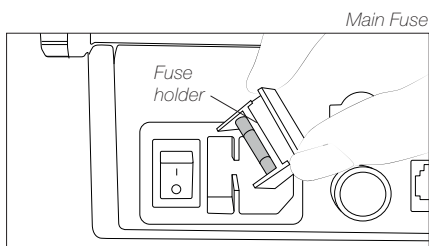

Safety



It is imperative to follow safety guidelines to prevent electric shock, injury, fire or explosion.

- Do not use the units for any purpose other than soldering or rework. Incorrect use may cause a fire.
- The power cord must be plugged into approved bases. Be sure that it is properly grounded before use. When unplugging it, hold the plug, not the wire.
- Do not work on electrically live parts.
- The tool should be placed in the stand when not in use in order to activate the sleep mode. The soldering tip or nozzle, the metal part of the tool and the stand may still be hot even when the station is turned off. Handle with care, including when adjusting the stand position.
- Do not leave the appliance unattended when it is on.
- Do not cover the ventilation grills. Heat can cause inflammable products to ignite.
- Avoid flux coming into contact with skin or eyes to prevent irritation.
- Be careful with the fumes produced when soldering.
- Keep your workplace clean and tidy. Wear appropriate protection glasses and gloves when working to avoid personal harm.
- Utmost care must be taken with liquid tin waste which can cause burns.
- This appliance can be used by children over the age of eight and also people with reduced physical, sensory or mental capabilities or lack of experience provided that they have been given adequate supervision or instruction concerning the use of the appliance and understand the hazards involved. Children must not play with the appliance.
- Maintenance must not be carried out by children unless supervised.

Specifications

CS

Precision Desoldering Station

Ref. **CS-9F** 100V 50/60Hz. Input fuse: T2A. Output: 23.5V.

Ref. **CS-1F** 120V 50/60Hz. Input fuse: T2A. Output: 23.5V.

Ref. **CS-2F** 230V 50/60Hz. Input fuse: T1A. Output: 23.5V.

- Peak Power (Tool): 40W
- Selectable Temperature: 180 - 450 °C / 360 - 840 °F
- Idle Temp. Stability (still air): $\pm 1.5^{\circ}\text{C}$ / $\pm 3^{\circ}\text{F}$ (Meets and exceed IPC J-STD-001)
- Temp Accuracy: $\pm 3\%$ (using reference cartridge)
- Temp Adjustment: $\pm 50^{\circ}\text{C}$ / $\pm 90^{\circ}\text{F}$ Through station menu setting
- Tip to Ground Voltage/Resistance: Meets and exceed
ANSI/ESD S20.20-2014 IPC J-STD-001F
- Earthing Fuse: F 1.25A
- Connections: USB connector station-PC
RJ12 Connector
- Ambient Operating Temp: 10 - 50 °C / 50 - 122 °F
- Control Unit Dimensions / Weight: 170 x 176 x 145 mm / 2.8 Kg
(L x W x H) 6.7 x 6.9 x 5.7 in / 6.17 lb

MS

Electric Desoldering Module for DI & CS

Ref. **MS-A**

- Dimensions / Weight: 145 x 55 x 225 mm / 1.2 kg
(L x W x H) 5.7 x 2.2 x 8.9 in / 2.6 lb
- Vacuum: 75% / 570 mmHg / 22.4 inHg
- Flow rate: 9 SLPM

- Total Package Dimensions / Weight: 495 x 295 x 255 mm / 5.47 kg
(L x W x H) 19.5 x 11.6 x 10 in / 12.06 lb

Complies with CE standards.

ESD safe.

JBC

Warranty

JBC's 2 year warranty covers this equipment against all manufacturing defects, including the replacement of defective parts and labour.

Warranty does not cover product wear or misuse.

In order for the warranty to be valid, equipment must be returned, postage paid, to the dealer where it was purchased.

Get 1 extra year JBC warranty by registering here:
<https://www.jbctools.com/productregistration/>
within 30 days of purchase.



This product should not be thrown in the garbage.

In accordance with the European directive 2012/19/EU, electronic equipment at the end of its life must be collected and returned to an authorized recycling facility.

CE EAC UK
CA

www.jbctools.com

0026947-300523