



**JBC**

The Soldering Co.

**烙铁头指南**

感受品质 独享尊荣

# 目录

---

最高效的焊接系统 .....	4
接触面越大, 工作越高效 .....	6
限制焊嘴寿命的因素 .....	7
焊嘴清洁系统 .....	8
<b>C115</b> 系列烙铁头— NT115纳米焊手柄、 AN115 可调式纳米镊夹和NP115纳米镊夹 .....	12
<b>C120</b> 系列烙铁头— PA120微型镊夹和AM120可调式微型镊夹 .....	16
<b>C210</b> 系列烙铁头-T210、B-IRON 100和500 精密型手柄 .....	18
<b>C245</b> 系列烙铁头— T245 通用型手柄 .....	22
<b>C245L</b> 加长型系列烙铁头- T245通用型手柄 .....	39
<b>C245E</b> 延长寿命系列烙铁头— T245 通用型手柄 .....	45
<b>C250</b> 系列烙铁头— ALE250自动送锡枪和AP250送锡枪 .....	47
<b>C250E</b> 延长寿命系列烙铁头- ALE250自动送锡枪和AP250送锡枪 .....	49
<b>C420</b> 系列烙铁头— AT420可调式导热镊夹和HT420导热镊夹 .....	50
<b>C470</b> 系列烙铁头— T470重负荷手柄和HT470重负荷导热镊夹 .....	52
<b>C360</b> 系列小型吸锡嘴— DS360微型吸锡手柄 .....	60
<b>C560</b> 系列吸锡嘴— DR560吸锡手柄 .....	62
<b>W140</b> 系列铲型烙铁头— WS140精密剥线镊夹 .....	64
<b>W440</b> 系列铲型烙铁头— WS440剥线镊夹 .....	66

## JBC 技术 最高效的焊接系统

JBC焊台采用JBC专有加热系统,可快速恢复焊嘴温度。提高工作效率并让使用者在较低温度下工作。

### 高效的温度控制

下图为连续点焊三个焊点的烙铁头回温比较数据

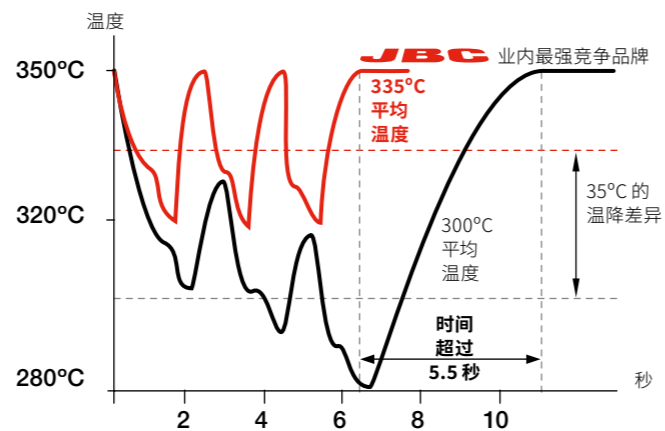

JBC烙铁头降温最多30度,而其他品牌则高达70度。

高效温度控制 ➤ 提升质量  
提高生产力

## 生产力

焊嘴到传感器的距离短,回温极快,精确控制。

### 加热系统原理 两秒内达到350°C

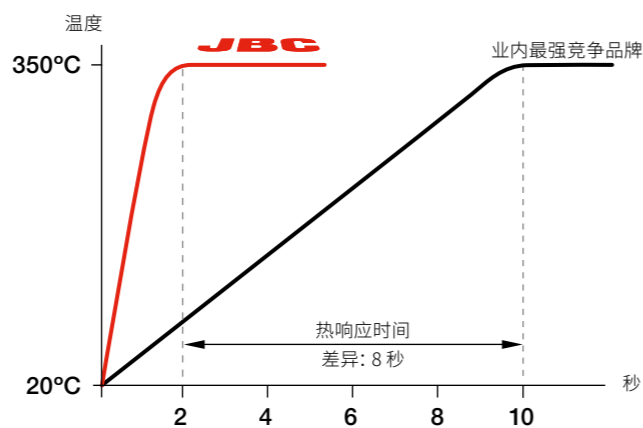

\*该曲线图对JBC C210系列烙铁头与业内最强竞争者的同一类型产品进行了对比。

### 全球化服务

JBC 是一家全球化公司,其经销商网络覆盖五大洲,凭借快速有效的服务使其成为一个稳固可靠的商业组织。

### 经验的力量

凭借 90 多年的丰富经验, JBC 已在电子行业的焊接和返修作业工具领域中引领技术前沿。为满足专家们最为严苛的要求,我们设计了一系列产品,创新、高效和可靠性是其关键特征。

### 高科技,高质量

产品的完美性是 JBC 改进和发展计划的主要目标之一。研发部门创造了令 JBC 引以为豪的最具创新性的焊接技术,本目录将予以展示。

**CE**  
**ESD safe**

JBC 所有产品均符合 CE 标准和 ESD 规范。

**BORN FOR LEAD FREE**

JBC Soldering SL. 保留更新、修改或删除任何信息的权力,不另行通知。

## 智能热管理

得益于支架对工具的自动检测功能,在未使用的工具时候, JBC焊台及返修工作站可进入**睡眠和休眠模式**。因此,焊嘴的使用寿命可延长至5倍。

### 睡眠模式

当工具置于支架时,睡眠模式可使焊嘴温度自动降至锡料熔点以下,以防止烙铁头铁镀层溶解。

### 休眠模式

当睡眠模式的设定时间到时,主机将自动进入**休眠模式**。电源将自动切断,焊嘴恢复到室温,烙铁头因而减少氧化,并降低不必要的电源损耗。

### 烙铁头寿命延长

使用如图所示的较低温度,焊嘴的使用寿命将成倍延长。使用**睡眠模式**可进一步降低烙铁头温度,从而将焊嘴的使用寿命延长 5 倍。

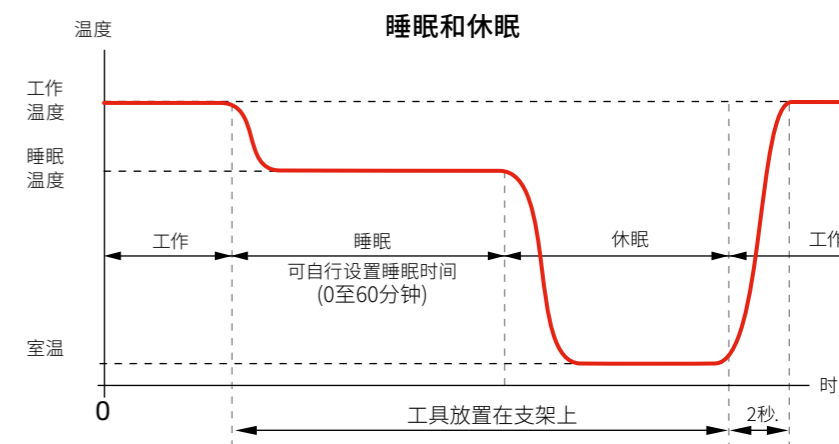

### 烙铁头的使用寿命最多延长 5 倍

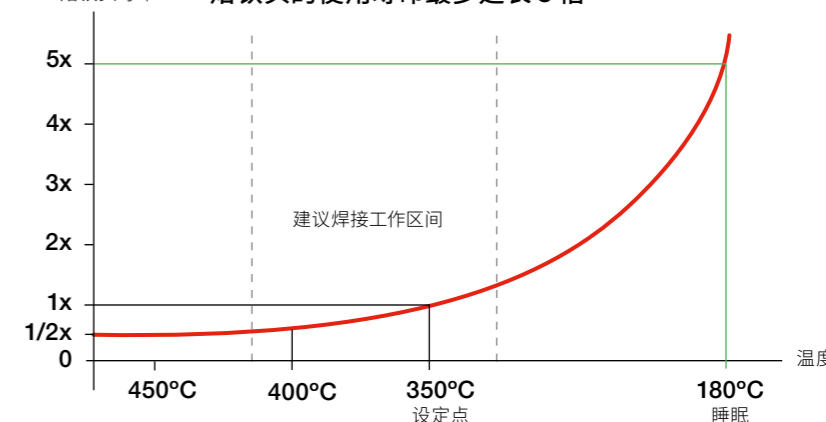

## 长寿命和延长寿命系列烙铁头

为满足各种焊接的应用需求, JBC 提供多达500种不同规格和形状的烙铁头。

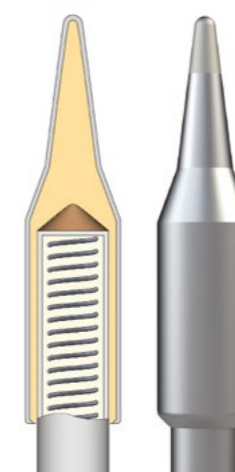

JBC 基于以下原则开发了最先进的技术:

**卓越的热传导**  
紧实的内芯减少导热障碍。

**瞬间加热**  
烙铁头内的热感应器可确保温度快速恢复。

**优良的耐用性**  
智能算法控制程序可延长烙铁头寿命。

# 接触面越大, 工作越高效

开始焊接时, 请记住焊嘴的接触面越大, 导热性越好。  
选购烙铁头时, 请选择与被焊器件有最大接触面的烙铁头。

## 超过500款不同大小, 形状和功率输出的烙铁头

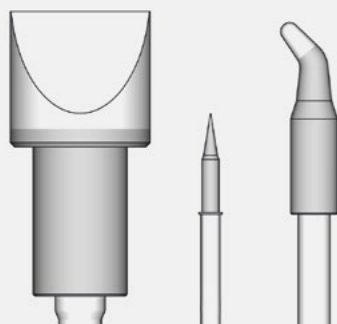

JBC烙铁头系列涵盖了高精密至高功率需求的焊接作业。

## 焊嘴大小vs.效率

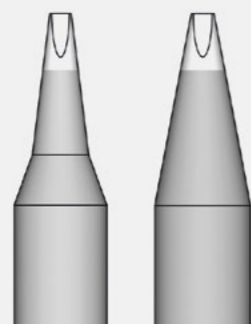

相较于图左较细的焊嘴, 图右较粗的焊嘴内含较多导热物质, 可将热效能提增40%。

## 增加焊嘴与元器件接触面

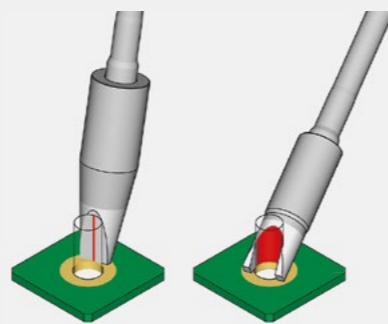

焊嘴与元器件的接触面越大, 导热效果越好。

## 建议选择尽可能大接触面的焊嘴

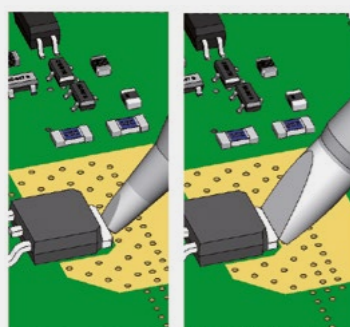

焊嘴的接触面越大, 积累的热能越多, 降温越小。

## 保持焊嘴表面清洁并上锡



生锈或肮脏的焊嘴表面会降低热传导效能。清洁焊嘴后, 请重新上新锡做保养, 以延长焊嘴寿命。(请参考第8页至第9页清洁方式的相关说明。)

## 注意上述几点, 您可以:

- ▶ 在较低的温度下进行焊接。(350°C)
- ▶ 在更短时间内获得更优质的焊接效果。
- ▶ 改善导热性能。
- ▶ 提高焊接温度准确度。
- ▶ 降低连带损伤被焊器件的可能性。(例如热冲击对元器件造成损害)

# 限制焊嘴寿命的因素

## 焊接作业温度

焊接作业温度越高, 越容易造成焊嘴氧化腐蚀。请选用与被焊器件接触面最大的焊嘴, 并尽可能维持低温完成焊接作业。请使用导热性好的工具, 并保持焊嘴清洁无氧化。

## 正确操作方式

用力过猛会造成元器件及焊嘴的损毁。请勿将焊嘴当成螺丝刀或尖锐物去触碰任何物件。请根据焊接作业的情况选择合适的焊嘴及焊接温度。

## 镀铁层厚度

焊嘴侵蚀或磨损都会造成烙铁头寿命的缩短。请勿使用任何机械或化学方式来清洁焊嘴。请采用原厂提供的清洁方式, 例如黄铜丝清洁球、自动焊嘴清洁机或海绵等。

## 焊嘴氧化

氧化后的焊嘴, 其导热性降低且不易吃锡。焊嘴温度越高其氧化机率也越高。为了避免焊嘴氧化, 在不使用的时候, 请保持焊嘴的上锡状态, 并利用JBC焊台的睡眠及休眠模式设定。

## 助焊剂和焊料合金

焊接过程中使用过多助焊剂会造成被焊元器件的腐蚀。IPC推荐助焊剂标识符合: ROL、REL及ORL。小直径锡线的助焊剂含量可能量不足, 因此在必要的情况下, 请使用助焊剂。

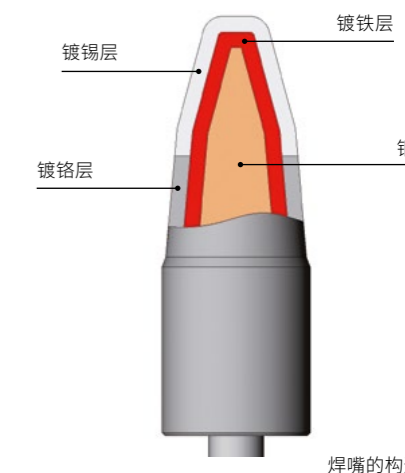

焊嘴的构造

## 请记住:

- ▶ 使用尽可能低的温度完成焊接工作。
- ▶ 选用导热性好的工具。
- ▶ 根据焊接作业的情况选择合适的温度及焊嘴。
- ▶ IPC推荐助焊剂标识符合: ROL、REL及ORL。
- ▶ 烙铁头不使用时, 请将保持焊嘴的上锡状态。
- ▶ 利用JBC焊台的睡眠及休眠模式设定。
- ▶ 用力过猛会造成元器件及焊嘴的损毁。
- ▶ 采用原厂提供的清洁方式。



# 烙铁头清洁系统

为了使焊嘴保持良好的导热性，请将焊嘴上锡以避免氧化。

## 一秒内清洁焊嘴



使用自动焊嘴清洁机可节省时间、提高生产效率

## 提高导热性能

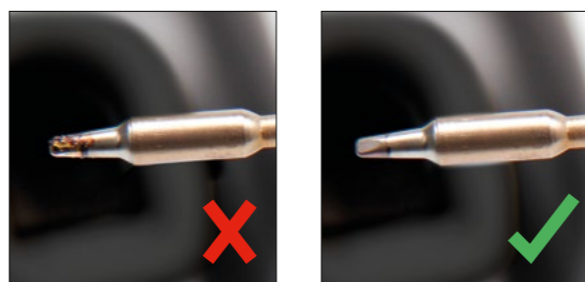

干净的焊嘴更容易上锡，焊点质量更佳。

## CL 焊嘴清洁座

手动清洁烙铁头专用。  
内置黄铜丝清洁球及外附防溅膜的组合设计，方便清洁烙铁头，同时保持工作区域清洁。



### 清洁方式

**CL6210 黄铜丝清洁球**  
非常有效的清洁方法。可在焊嘴上留下薄薄一层锡，防止在清洁和再浸湿的间隙发生氧化。



**S0354 清洁海绵**  
最柔和的清洁方式。使用时请用蒸馏水保持海绵湿润，以避免焊嘴磨损。



## CLMS 小型自动焊嘴清洁机 (带纤维刷, 非金属)

### 两种操作模式

通过按钮或选择持续运转模式启动电动刷。



### 节省空间

得益于焊嘴清洁机缩小的体积，可轻易将其放置于您的工作区域。

### 清洁刷

**CL4008 纤维刷**  
其成分、尺寸和纤维的厚度确保最有效的清洁效果，并在清洁焊嘴造成最小的损坏。



## 自动焊嘴清洁机

**CLMUP 自动焊嘴清洁机(非金属纤维刷)**  
轻柔彻底地清洁焊嘴，增强热传递，并最大地提高焊接质量。

**CLMU 自动焊嘴清洁机(金属纤维刷)**  
轻柔强效地清洁并恢复焊嘴，增加热传递。随附的金属刷可提供深度清洁。



## 感应模式

当焊嘴靠近传感器，触发清洁刷旋转。当焊嘴移开，清洁刷自动停止旋转。



## 垂直位置

可垂直清洁焊嘴。



## 保持工作区域清洁

清洁刷的锁扣功能可快捷方便地更换刷头。焊锡收集器更容易清空。



### 清洁刷

**CL2008 / CL2007 纤维刷**  
提供柔和的清洁方式，特别推荐经常使用以延长焊嘴寿命。



**CL1008 / CL1007 金属刷**  
提供彻底清洁和还原焊嘴的方式，并增强导热性。随 CLMU 提供。





JBC致力于满足客户特定需求, 并与其紧密合作, 以创建**最佳解决方案**。与此同时, 我们的烙铁头系列正在逐步稳增。

**C115系列烙铁头— NT115纳米焊接手柄、AN115  
可调式纳米镊夹和NP115纳米镊夹**

产品料号	产品规格	产品图片	推荐用途	搭配产品
<b>C115116</b>	凿型烙铁头 0.2 x 0.1 mm		01005、0201 元件 0.4mm 极细焊缝距 QFP, IC	焊台: NASE, NANE, CDN 工具: NT115, AN115, NP115
<b>C115117</b>	凿型烙铁头 0.4 x 0.2 mm		0402 元件 0.65 mm 极细焊缝距 QFP, IC	焊台: NASE, NANE, CDN 工具: NT115, AN115, NP115
<b>C115108</b>	凿型烙铁头 0.6 x 0.3 mm		0603 元件 PLCC, SO, SOT	焊台: NASE, NANE, CDN 工具: NT115, AN115, NP115
<b>C115125</b>	凿型烙铁头 1 x 0.2 mm		0805 元件 难以触及的被焊物	焊台: NASE, NANE, CDN 工具: NT115, AN115, NP115
<b>C115113</b>	凿型烙铁头 1 x 0.3 mm		0805 元件 穿孔焊接	焊台: NASE, NANE, CDN 工具: NT115, AN115, NP115
<b>C115213</b>	凿型烙铁头 1 x 0.3 S1 mm		0805 元件 穿孔焊接 高热性能	焊台: NASE, NANE, CDN 工具: NT115, AN115, NP115
<b>C115221</b>	凿型烙铁头 1.3 x 0.3 mm		0805 元件 穿孔焊接 高热性能	焊台: NASE, NANE, CDN 工具: NT115, AN115, NP115
<b>C115222</b>	凿型烙铁头 1.6 x 0.3 mm		0805 元件 穿孔焊接 高热性能	焊台: NASE, NANE, CDN 工具: NT115, AN115, NP115









**C115系列烙铁头— NT115纳米焊接手柄、AN115可调式纳米镊夹和NP115纳米镊夹**

产品料号	产品规格	产品图片	推荐用途	搭配产品
<b>C115114</b>	凿型烙铁头 1.8 x 0.5 mm		0805 元件 穿孔焊接	焊台: NASE, NANE, CDN 工具: NT115, AN115, NP115
<b>C115214</b>	凿型烙铁头 1.8 x 0.5 mm S1		1206、1210 元件 穿孔焊接 高热性能	焊台: NASE, NANE, CDN 工具: NT115, AN115, NP115
<b>C115223</b>	凿型烙铁头 2.4 x 0.6 mm		0805 元件 穿孔焊接 高热性能	焊台: NASE, NANE, CDN 工具: NT115, AN115, NP115
<b>C115109</b>	斜面烙铁头 Ø 0.6 mm		SMD穿孔拖焊	焊台: NASE, NANE, CDN 工具: NT115, AN115, NP115
<b>C115127</b>	斜面烙铁头 Ø 1 mm		SMD穿孔拖焊	焊台: NASE, NANE, CDN 工具: NT115, AN115, NP115
<b>C115128</b>	勺型烙铁头 Ø 1 mm		SMD穿孔拖焊	焊台: NASE, NANE, CDN 工具: NT115, AN115, NP115
<b>C115126</b>	圆锥型烙铁头 Ø 0.1 mm S1		01005 元件 0.4 mm 极细焊缝距 QFP, IC	焊台: NASE, NANE, CDN 工具: NT115, AN115, NP115
<b>C115101</b>	圆锥型烙铁头 Ø 0.1 mm		01005 元件 0.4 mm 极细焊缝距 QFP, IC	焊台: NASE, NANE, CDN 工具: NT115, AN115, NP115

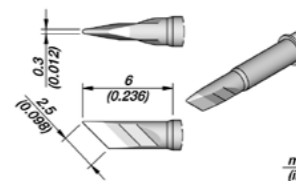
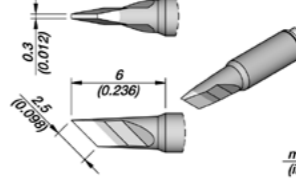
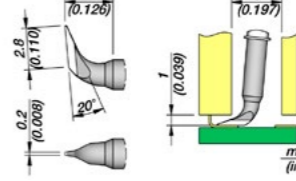
C115系列烙铁头— NT115纳米焊接手柄、AN115可调式纳米镊夹和NP115纳米镊夹

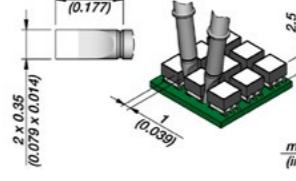
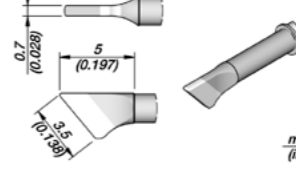
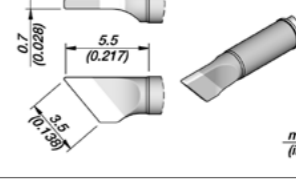
产品料号	产品规格	产品图片	推荐用途	搭配产品
	<b>C115103</b> 圆锥型烙铁头 Ø 0.3 mm S1		0201、0402 元件 0.65 mm 极细焊缝距 QFP, IC	焊台: NASE, NANE, CDN 工具: NT115, AN115, NP115
<b>C115106</b>	圆锥型烙铁头 Ø 0.5 mm		0603 元件 QFP, IC	焊台: NASE, NANE, CDN 工具: NT115, AN115, NP115
<b>C115107</b>	圆锥型烙铁头 Ø 0.8 mm		通用焊接	焊台: NASE, NANE, CDN 工具: NT115, AN115, NP115
	<b>C115124</b> 圆锥弯型烙铁头 Ø 0.1 mm S1		01005 元件 0.4mm 极细焊缝距 QFP, IC	焊台: NASE, NANE, CDN 工具: NT115, AN115, NP115
<b>C115118</b>	圆锥弯型烙铁头 Ø 0.1 mm		01005 元件 0.4mm 极细焊缝距 QFP, IC	焊台: NASE, NANE, CDN 工具: NT115, AN115, NP115
<b>C115105</b>	圆锥弯型烙铁头 Ø 0.3 mm		0201、0402 元件 0.65 mm 缝距 QFP, IC	焊台: NASE, NANE, CDN 工具: NT115, AN115, NP115
<b>C115110</b>	圆锥弯型烙铁头 Ø 0.5 mm		0603 元件 QFP, IC	焊台: NASE, NANE, CDN 工具: NT115, AN115, NP115
	<b>C115120</b> 刀型烙铁头 1 x 0.2 mm		SMD 拖焊焊接 0805 元件 穿孔焊接	焊台: NASE, NANE, CDN 工具: NT115, AN115, NP115

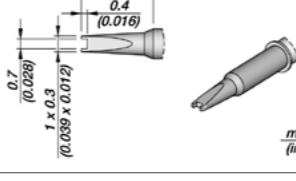
C115系列烙铁头— NT115纳米焊接手柄、AN115可调式纳米镊夹和NP115纳米镊夹

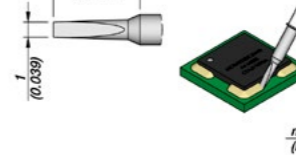
产品料号	产品规格	产品图片	推荐用途	搭配产品
	<b>C115112</b> 刀型烙铁头 2.5 x 0.3 mm		SMD 拖焊焊接 SO, SOT 1210、1812、2010、 2512 元件	焊台: NASE, NANE, CDN 工具: NT115, AN115, NP115
<b>C115212</b>	刀型烙铁头 2.5 x 0.3 mm S1		SMD 拖焊焊接 SO, SOT 1210、1812、2010、 2512 元件 高热性能	焊台: NASE, NANE, CDN 工具: NT115, AN115, NP115
<b>C115129</b>	刀型烙铁头 2.8 x 0.2 mm		IC, 难以触及的被焊物	焊台: NASE, NANE, CDN 工具: NT115, AN115, NP115
	<b>C115131</b> 铲型烙铁头 2 x 0.35 mm		LED SMD 2727, 1921, 1415	焊台: NASE, NANE, CDN 工具: NT115, AN115, NP115
<b>C115111</b>	铲型烙铁头 3.5 x 0.7 mm		1210、1812 元件 SO, SOT	焊台: NASE, NANE, CDN 工具: NT115, AN115, NP115
<b>C115211</b>	铲型烙铁头 3.5 x 0.7 mm S1		1210、1812 元件 SO, SOT 高热性能	焊台: NASE, NANE, CDN 工具: NT115, AN115, NP115
	<b>C115132</b> 芯片组件专用 凹型烙铁头 0.7 mm		0201 元件	焊台: NASE, NANE, CDN 工具: NT115, AN115, NP115
	<b>C115115</b> 除胶烙铁头 1 mm		去除三防胶涂膜专用	焊台: NASE, NANE, CDN 工具: NT115, AN115, NP115







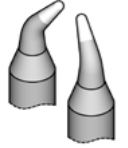
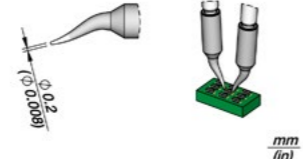
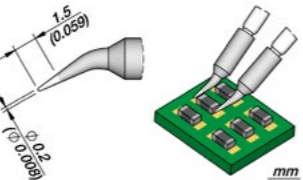
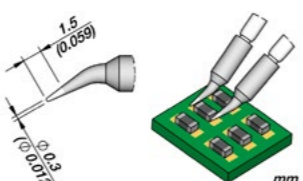
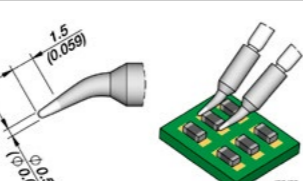
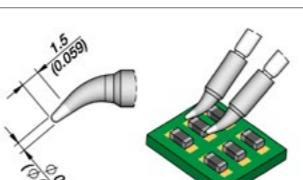
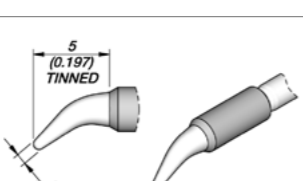
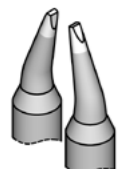
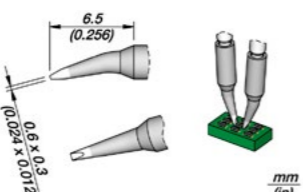

**C120系列烙铁头—AM120可调式微型镊夹和PA120微型镊夹**

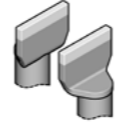
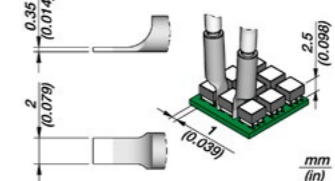
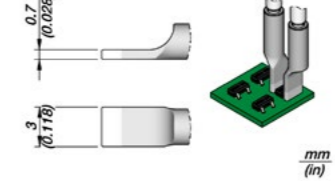
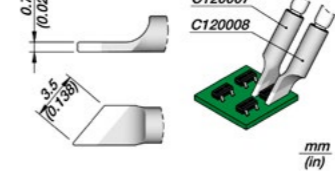
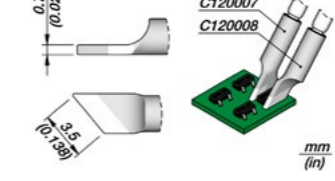
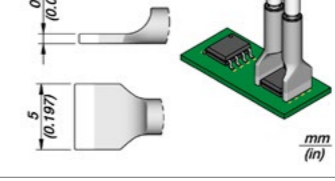
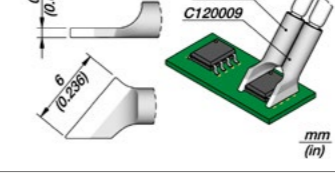
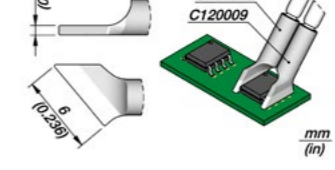
产品料号	产品规格	产品图片	推荐用途	搭配产品
 <b>C120001</b>	圆锥弯型双列烙铁头 Ø 0.2 mm		0201、0402 元件	焊台: CP, DI, DDE, DME 工具: AM120, PA120
<b>C120002</b>	圆锥弯型双列烙铁头 Ø 0.2 mm		0201、0402 元件	焊台: CP, DI, DDE, DME 工具: AM120, PA120
<b>C120902</b>	圆锥弯型双列烙铁头 Ø 0.3 mm		0201、0402 元件 0.65 mm 缝距 QFP, IC	焊台: CP, DI, DDE, DME 工具: AM120, PA120
<b>C120006</b>	圆锥弯型双列烙铁头 Ø 0.5 mm		0603 元件 QFP, IC	焊台: CP, DI, DDE, DME 工具: AM120, PA120
<b>C120004</b>	圆锥弯型双列烙铁头 Ø 0.7 mm S1		SMD电容器 QFP, IC 穿孔焊接	焊台: CP, DI, DDE, DME 工具: AM120, PA120
<b>C120012</b>	圆锥弯型双列烙铁头 Ø 0.7 mm S2		SMD电容器 QFP, IC 穿孔焊接 大面积锡镀层覆盖的焊嘴	焊台: CP, DI, DDE, DME 工具: AM120, PA120
 <b>C120011</b>	凿弯型双列烙铁头 0.6 x 0.3 mm		0603 元件	焊台: CP, DI, DDE, DME 工具: AM120, PA120



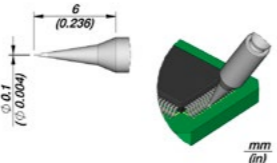
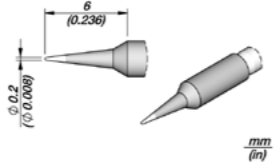
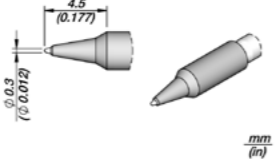
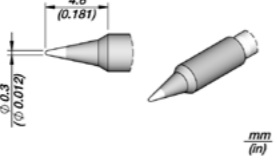
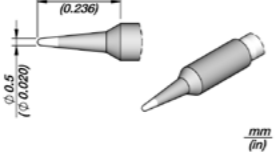
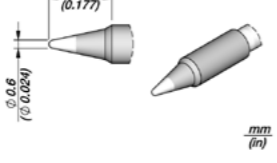
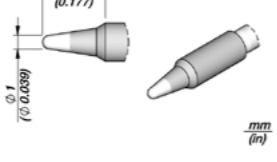

**C120系列烙铁头—AM120可调式微型镊夹和PA120微型镊夹**

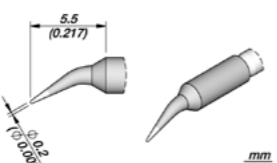
产品料号	产品规格	产品图片	推荐用途	搭配产品
 <b>C120013</b>	铲型双列烙铁头 2 mm		LED SMD 2727, 1921, 1415	焊台: CP, DI, DDE, DME 工具: AM120, PA120
<b>C120003</b>	铲型双列烙铁头 3 mm		1210、1812 元件 SO, SOT	焊台: CP, DI, DDE, DME 工具: AM120, PA120
<b>C120007</b>	铲型双列烙铁头 3.5 mm 右		1210、1812 元件 SO, SOT	焊台: CP, DI, DDE, DME 工具: AM120, PA120
<b>C120008</b>	铲型双列烙铁头 3.5 mm 左		1210、1812 元件 SO, SOT	焊台: CP, DI, DDE, DME 工具: AM120, PA120
<b>C120005</b>	铲型双列烙铁头 5 mm		SO, SOT	焊台: CP, DI, DDE, DME 工具: AM120, PA120
<b>C120009</b>	铲型双列烙铁头 6 mm Right		SO, SOT	焊台: CP, DI, DDE, DME 工具: AM120, PA120
<b>C120010</b>	铲型双列烙铁头 6 mm Left		SO, SOT	焊台: CP, DI, DDE, DME 工具: AM120, PA120



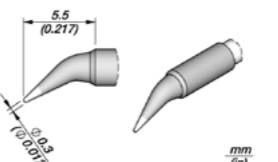
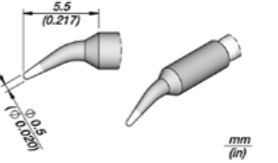
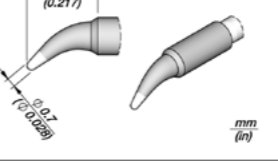

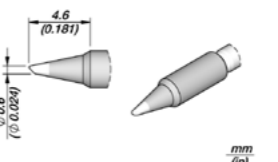
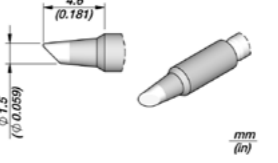
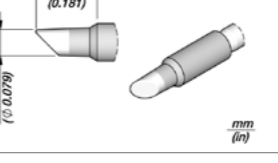
**C210系列烙铁头-T210、B·IRON 100和500  
精密型手柄**

产品料号	产品规格	产品图片	推荐用途	搭配产品
	<b>C210020</b> 圆锥型烙铁头 Ø 0.1 mm		01005、0201 元件 0.4mm 极细焊缝距 QFP, IC	焊台: CDS, DI, DDE, DME, B-IRON 100和500 工具: T210, T210P, T210N, B-IRON 100和500
<b>C210009</b>	圆锥型烙铁头 Ø 0.2 mm		01005、0201 元件 0.4mm 极细焊缝距 QFP, IC	焊台: CDS, DI, DDE, DME, B-IRON 100和500 工具: T210, T210P, T210N, B-IRON 100和500
<b>C210016</b>	圆锥型烙铁头 Ø 0.3 mm S1		0201、0402 元件 0.65 mm 缝距 QFP, IC	焊台: CDS, DI, DDE, DME, B-IRON 100和500 工具: T210, T210P, T210N, B-IRON 100和500
<b>C210001</b>	圆锥型烙铁头 Ø 0.3 mm S2		0201、0402 元件 0.65 mm 缝距 QFP, IC	焊台: CDS, DI, DDE, DME, B-IRON 100和500 工具: T210, T210P, T210N, B-IRON 100和500
<b>C210013</b>	圆锥型烙铁头 Ø 0.5 mm		0603 元件 QFP, IC	焊台: CDS, DI, DDE, DME, B-IRON 100和500 工具: T210, T210P, T210N, B-IRON 100和500
<b>C210003</b>	圆锥型烙铁头 Ø 0.6 mm		通用焊接	焊台: CDS, DI, DDE, DME, B-IRON 100和500 工具: T210, T210P, T210N, B-IRON 100和500
<b>C210005</b>	圆锥型烙铁头 Ø 1 mm		通用焊接	焊台: CDS, DI, DDE, DME, B-IRON 100和500 工具: T210, T210P, T210N, B-IRON 100和500
	<b>C210002</b> 圆锥弯型烙铁头 Ø 0.2 mm		0201、0402 元件	焊台: CDS, DI, DDE, DME, B-IRON 100和500 工具: T210, T210P, T210N, B-IRON 100和500

**C210系列烙铁头-T210、B·IRON 100和500 精密型手柄**

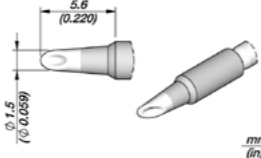
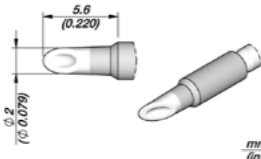
产品料号	产品规格	产品图片	推荐用途	搭配产品
	<b>C210010</b> 圆锥弯型烙铁头 Ø 0.3 mm		0201、0402 元件 0.65 mm 缝距 QFP, IC	焊台: CDS, DI, DDE, DME, B-IRON 100和500 工具: T210, T210P, T210N, B-IRON 100和500
<b>C210014</b>	圆锥弯型烙铁头 Ø 0.5 mm		0603 元件 QFP, IC	焊台: CDS, DI, DDE, DME, B-IRON 100和500 工具: T210, T210P, T210N, B-IRON 100和500
<b>C210004</b>	圆锥弯型烙铁头 Ø 0.7 mm		通用焊接	焊台: CDS, DI, DDE, DME, B-IRON 100和500 工具: T210, T210P, T210N, B-IRON 100和500
	<b>C210036</b> 斜面烙铁头 Ø 0.6 mm		拖焊焊接 通用焊接	焊台: CDS, DI, DDE, DME, B-IRON 100和500 工具: T210, T210P, T210N, B-IRON 100和500
<b>C210006</b>	斜面烙铁头 Ø 1 mm		拖焊焊接 通用焊接	焊台: CDS, DI, DDE, DME, B-IRON 100和500 工具: T210, T210P, T210N, B-IRON 100和500
<b>C210027</b>	斜面烙铁头 Ø 1.5 mm		拖焊焊接 通用焊接	焊台: CDS, DI, DDE, DME, B-IRON 100和500 工具: T210, T210P, T210N, B-IRON 100和500
<b>C210031</b>	斜面烙铁头 Ø 2 mm		拖焊焊接 通用焊接	焊台: CDS, DI, DDE, DME, B-IRON 100和500 工具: T210, T210P, T210N, B-IRON 100和500
<b>C210040</b>	斜面烙铁头 Ø 2.9 mm		拖焊焊接 通用焊接	焊台: CDS, DI, DDE, DME, B-IRON 100和500 工具: T210, T210P, T210N, B-IRON 100和500
	<b>C210028</b> 勺型烙铁头 Ø 1 mm		拖焊焊接	焊台: CDS, DI, DDE, DME, B-IRON 100和500 工具: T210, T210P, T210N, B-IRON 100和500

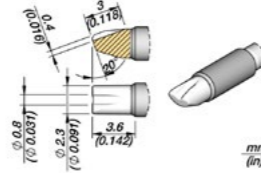
C210系列烙铁头-T210、B-IRON 100和500 精密型手柄

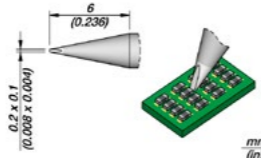
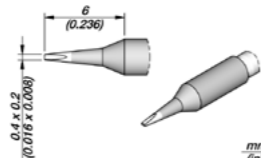
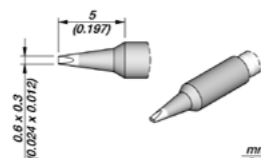
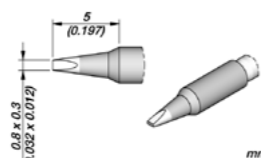
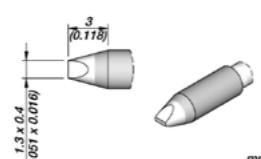
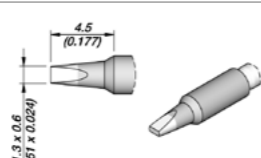
产品图片	产品料号	产品规格	产品图片	推荐用途	搭配产品
	C210029	勺型烙铁头 Ø 1.5 mm		拖焊焊接	焊台: CDS, DI, DDE, DME, B-IRON 100和500 工具: T210, T210P, T210N, B-IRON 100和500
	C210030	勺型烙铁头 Ø 2 mm		拖焊焊接	焊台: CDS, DI, DDE, DME, B-IRON 100和500 工具: T210, T210P, T210N, B-IRON 100和500
	C210038	U型 Ø 8 mm		穿孔线材焊接及拆焊	焊台: CDS, DI, DDE, DME, B-IRON 100和500 工具: T210, T210P, T210N, B-IRON 100和500
	C210019	凿型烙铁头 0.2 x 0.1 mm		01005、0201 元件 0.4mm 极细焊缝距 QFP, IC	焊台: CDS, DI, DDE, DME, B-IRON 100和500 工具: T210, T210P, T210N, B-IRON 100和500
	C210023	凿型烙铁头 0.4 x 0.2 mm		0402 元件 0.65mm 极细焊缝距 QFP, IC	焊台: CDS, DI, DDE, DME, B-IRON 100和500 工具: T210, T210P, T210N, B-IRON 100和500
	C210021	凿型烙铁头 0.6 x 0.3 mm		0603 元件	焊台: CDS, DI, DDE, DME, B-IRON 100和500 工具: T210, T210P, T210N, B-IRON 100和500
	C210024	凿型烙铁头 0.8 x 0.3 mm		0805 元件 穿孔焊接	焊台: CDS, DI, DDE, DME, B-IRON 100和500 工具: T210, T210P, T210N, B-IRON 100和500
	C210022	凿型烙铁头 1.3 x 0.4 mm		0805 元件 穿孔焊接	焊台: CDS, DI, DDE, DME, B-IRON 100和500 工具: T210, T210P, T210N, B-IRON 100和500
	C210008	凿型烙铁头 1.3 x 0.6 mm		0805 元件 穿孔焊接	焊台: CDS, DI, DDE, DME, B-IRON 100和500 工具: T210, T210P, T210N, B-IRON 100和500

C210系列烙铁头-T210、B-IRON 100和500 精密型手柄

产品图片	产品料号	产品规格	产品图片	推荐用途	搭配产品
	C210007	凿型烙铁头 2.3 x 0.7 mm		0805 元件 穿孔焊接	焊台: CDS, DI, DDE, DME, B-IRON 100和500 工具: T210, T210P, T210N, B-IRON 100和500
	C210039	凿型烙铁头 2.9 x 0.7 mm		0805 元件 穿孔焊接	焊台: CDS, DI, DDE, DME, B-IRON 100和500 工具: T210, T210P, T210N, B-IRON 100和500
	C210017	引线/连接器专用烙铁头 Ø 0.7 mm		穿孔焊接	焊台: CDS, DI, DDE, DME, B-IRON 100和500 工具: T210, T210P, T210N, B-IRON 100和500
	C210015	引线/连接器专用烙铁头 Ø 0.8 mm		穿孔同轴电缆焊接	焊台: CDS, DI, DDE, DME, B-IRON 100和500 工具: T210, T210P, T210N, B-IRON 100和500
	C210025	引线/连接器专用烙铁头 Ø 1.1 mm		穿孔同轴电缆焊接	焊台: CDS, DI, DDE, DME, B-IRON 100和500 工具: T210, T210P, T210N, B-IRON 100和500
	C210012	引线/连接器专用烙铁头 Ø 1 mm		电线、连接器	焊台: CDS, DI, DDE, DME, B-IRON 100和500 工具: T210, T210P, T210N, B-IRON 100和500
	C210033	刀型烙铁头 2.5 x 0.3 mm		SMD 拖焊焊接 SO, SOT 1210、1812、2010、 2512 元件	焊台: CDS, DI, DDE, DME, B-IRON 100和500 工具: T210, T210P, T210N, B-IRON 100和500
	C210018	刀型烙铁头 3.4 x 0.3 mm		SMD 拖焊焊接 SO, SOT 1210、1812、2010、 2512 元件	焊台: CDS, DI, DDE, DME, B-IRON 100和500 工具: T210, T210P, T210N, B-IRON 100和500
	C210034	除胶烙铁头 1 x 0.1 mm		去除三防胶涂膜专用	焊台: CDS, DI, DDE, DME, B-IRON 100和500 工具: T210, T210P, T210N, B-IRON 100和500



**C245 系列烙铁头— T245 通用型手柄**

产品料号	产品规格	产品图片	推荐用途	搭配产品
<b>C245030</b>	圆锥型烙铁头 Ø 0.3 mm		0201、0402 元件 0.65 mm 缝距 QFP, IC	焊台: CDB, CDEB, DI, DDE, DME 工具: T245, T245G, T245P, T245N
<b>C245032</b>	圆锥型烙铁头 Ø 0.4 mm		0201、0402 元件 0.65 mm 缝距 QFP, IC	焊台: CDB, CDEB, DI, DDE, DME 工具: T245, T245G, T245P, T245N
<b>C245036</b>	圆锥型烙铁头 Ø 0.5 mm S1		0603 元件 QFP, IC	焊台: CDB, CDEB, DI, DDE, DME 工具: T245, T245G, T245P, T245N
<b>C245930</b>	圆锥型烙铁头 Ø 0.5 mm S2		0603 元件 QFP, IC	焊台: CDB, CDEB, DI, DDE, DME 工具: T245, T245G, T245P, T245N
<b>C245001</b>	圆锥型烙铁头 Ø 0.6 mm		0603 元件 QFP, IC	焊台: CDB, CDEB, DI, DDE, DME 工具: T245, T245G, T245P, T245N
<b>C245937</b>	圆锥型烙铁头 Ø 0.6 mm HT		0603 元件 QFP, IC	焊台: CDB, CDEB, DI, DDE, DME 工具: T245, T245G, T245P, T245N
<b>C245957</b>	圆锥型烙铁头 Ø 0.8 mm		穿孔焊接	焊台: CDB, CDEB, DI, DDE, DME 工具: T245, T245G, T245P, T245N

**C245 系列烙铁头— T245 通用型手柄**

产品料号	产品规格	产品图片	推荐用途	搭配产品
<b>C245903</b>	圆锥型烙铁头 Ø 1 mm S1		通用焊接	焊台: CDB, CDEB, DI, DDE, DME 工具: T245, T245G, T245P, T245N
<b>C245041</b>	圆锥型烙铁头 Ø 1 mm S2		通用焊接 焊嘴大面积镀锡	焊台: CDB, CDEB, DI, DDE, DME 工具: T245, T245G, T245P, T245N
<b>C245403</b>	圆锥型烙铁头 Ø 1 HT mm		通用焊接	焊台: CDB, CDEB, DI, DDE, DME 工具: T245, T245G, T245P, T245N
<b>C245943</b>	圆锥型烙铁头 Ø 1.7 mm		通用焊接	焊台: CDB, CDEB, DI, DDE, DME 工具: T245, T245G, T245P, T245N
<b>C245933</b>	圆锥型烙铁头 Ø 2.2 mm		通用焊接	焊台: CDB, CDEB, DI, DDE, DME 工具: T245, T245G, T245P, T245N
<b>C245107</b>	圆锥型烙铁头 Ø 3 mm HT		通用焊接	焊台: CDB, CDEB, DI, DDE, DME 工具: T245, T245G, T245P, T245N
<b>C245034</b>	圆锥弯型烙铁头 Ø 0.4 mm S1		0201、0402 元件 0.65 mm 缝距 QFP, IC	焊台: CDB, CDEB, DI, DDE, DME 工具: T245, T245G, T245P, T245N
<b>C245029</b>	圆锥弯型烙铁头 Ø 0.4 mm S2		0201、0402 元件 0.65 mm 缝距 QFP, IC	焊台: CDB, CDEB, DI, DDE, DME 工具: T245, T245G, T245P, T245N

C245 系列烙铁头— T245 通用型手柄

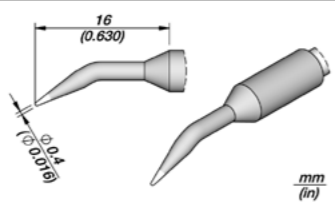
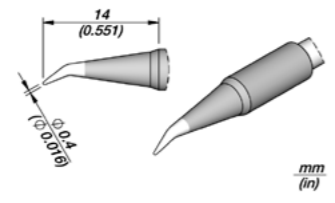
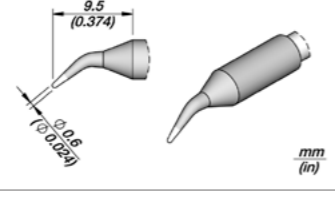
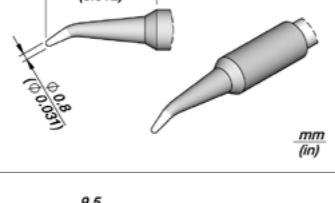
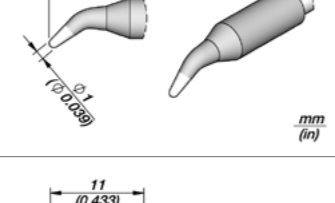
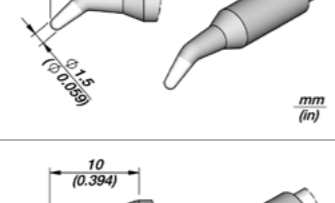
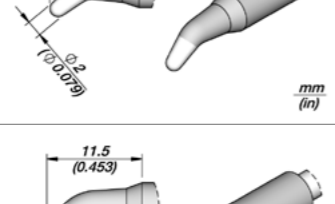
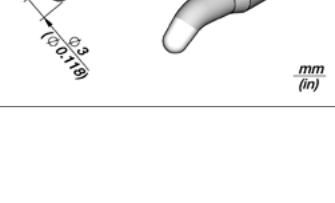
	产品料号	产品规格	产品图片	推荐用途	搭配产品
	<b>C245126</b>	圆锥弯型烙铁头 Ø 0.4 mm S3		0201、0402 元件 0.65 mm 缝距 QFP, IC	焊台: CDB, CDEB, DI, DDE, DME 工具: T245, T245G, T245P, T245N
	<b>C245786</b>	圆锥弯型烙铁头 Ø 0.4 mm S4		0201、0402 元件 0.65 mm 缝距 QFP, IC	焊台: CDB, CDEB, DI, DDE, DME 工具: T245, T245G, T245P, T245N
	<b>C245929</b>	圆锥弯型烙铁头 Ø 0.6 mm		0603 元件 QFP, IC	焊台: CDB, CDEB, DI, DDE, DME 工具: T245, T245G, T245P, T245N
	<b>C245935</b>	圆锥弯型烙铁头 Ø 0.8 mm		穿孔焊接	焊台: CDB, CDEB, DI, DDE, DME 工具: T245, T245G, T245P, T245N
	<b>C245904</b>	圆锥弯型烙铁头 Ø 1 mm		通用焊接	焊台: CDB, CDEB, DI, DDE, DME 工具: T245, T245G, T245P, T245N
	<b>C245259</b>	圆锥弯型烙铁头 Ø 1.5 mm		通用焊接	焊台: CDB, CDEB, DI, DDE, DME 工具: T245, T245G, T245P, T245N
	<b>C245260</b>	圆锥弯型烙铁头 Ø 2 mm HT		通用焊接	焊台: CDB, CDEB, DI, DDE, DME 工具: T245, T245G, T245P, T245N
	<b>C245627</b>	圆锥弯型烙铁头 Ø 3 mm		通用焊接	焊台: CDB, CDEB, DI, DDE, DME 工具: T245, T245G, T245P, T245N

C245 系列烙铁头— T245 通用型手柄

	产品料号	产品规格	产品图片	推荐用途	搭配产品
	<b>C245628</b>	圆锥弯型烙铁头 Ø 4 mm HT		通用焊接	焊台: CDB, CDEB, DI, DDE, DME 工具: T245, T245G, T245P, T245N
	<b>C245731</b>	凿型烙铁头 0.6 x 0.3 mm		0603 元件	焊台: CDB, CDEB, DI, DDE, DME 工具: T245, T245G, T245P, T245N
	<b>C245773</b>	凿型烙铁头 0.8 x 0.3 mm		0805 元件 穿孔焊接	焊台: CDB, CDEB, DI, DDE, DME 工具: T245, T245G, T245P, T245N
	<b>C245742</b>	凿型烙铁头 0.8 x 0.6 mm HT		0805 元件 穿孔焊接	焊台: CDB, CDEB, DI, DDE, DME 工具: T245, T245G, T245P, T245N
	<b>C245170</b>	凿型烙铁头 1 x 0.5 mm		通用焊接	焊台: CDB, CDEB, DI, DDE, DME 工具: T245, T245G, T245P, T245N
	<b>C245774</b>	凿型烙铁头 1.2 x 0.3 mm		通用焊接	焊台: CDB, CDEB, DI, DDE, DME 工具: T245, T245G, T245P, T245N
	<b>C245906</b>	凿型烙铁头 1.2 x 0.7 mm		通用焊接	焊台: CDB, CDEB, DI, DDE, DME 工具: T245, T245G, T245P, T245N
	<b>C245406</b>	凿型烙铁头 1.2 x 0.7 mm HT		通用焊接	焊台: CDB, CDEB, DI, DDE, DME 工具: T245, T245G, T245P, T245N



C245 系列烙铁头— T245 通用型手柄

产品料号	产品规格	产品图片	推荐用途	搭配产品
 <b>C245768</b>	凿型烙铁头 1.5 x 0.3 mm		通用焊接	焊台: CDB, CDEB, DI, DDE, DME 工具: T245, T245G, T245P, T245N
<b>C245171</b>	凿型烙铁头 1.8 x 0.5 mm		通用焊接	焊台: CDB, CDEB, DI, DDE, DME 工具: T245, T245G, T245P, T245N
<b>C245944</b>	凿型烙铁头 1.8 x 0.8 mm		通用焊接	焊台: CDB, CDEB, DI, DDE, DME 工具: T245, T245G, T245P, T245N
<b>C245907</b>	凿型烙铁头 2.2 x 1 mm		通用焊接	焊台: CDB, CDEB, DI, DDE, DME 工具: T245, T245G, T245P, T245N
<b>C245407</b>	凿型烙铁头 2.2 x 1 mm HT		通用焊接	焊台: CDB, CDEB, DI, DDE, DME 工具: T245, T245G, T245P, T245N
<b>C245770</b>	凿型烙铁头 2.4 x 0.3 mm		通用焊接	焊台: CDB, CDEB, DI, DDE, DME 工具: T245, T245G, T245P, T245N
<b>C245759</b>	凿型烙铁头 2.4 x 0.5 mm HT		通用焊接	焊台: CDB, CDEB, DI, DDE, DME 工具: T245, T245G, T245P, T245N
<b>C245741</b>	凿型烙铁头 2.4 x 0.6 mm HT		通用焊接	焊台: CDB, CDEB, DI, DDE, DME 工具: T245, T245G, T245P, T245N

C245 系列烙铁头— T245 通用型手柄

产品料号	产品规格	产品图片	推荐用途	搭配产品
 <b>C245729</b>	凿型烙铁头 2.7 x 1 mm		通用焊接	焊台: CDB, CDEB, DI, DDE, DME 工具: T245, T245G, T245P, T245N
<b>C245061</b>	凿型烙铁头 3 x 1 mm		通用焊接	焊台: CDB, CDEB, DI, DDE, DME 工具: T245, T245G, T245P, T245N
<b>C245911</b>	凿型烙铁头 3.2 x 1.2 mm		通用焊接	焊台: CDB, CDEB, DI, DDE, DME 工具: T245, T245G, T245P, T245N
<b>C245775</b>	凿型烙铁头 3.2 x 1.2 mm S1		通用焊接	焊台: CDB, CDEB, DI, DDE, DME 工具: T245, T245G, T245P, T245N
<b>C245755</b>	凿型烙铁头 4 x 0.8 mm HT		通用焊接	焊台: CDB, CDEB, DI, DDE, DME 工具: T245, T245G, T245P, T245N
<b>C245756</b>	凿型烙铁头 4.8 x 1 mm HT		通用焊接	焊台: CDB, CDEB, DI, DDE, DME 工具: T245, T245G, T245P, T245N
<b>C245908</b>	凿型烙铁头 4.8 x 1.5 mm HT S1		通用焊接	焊台: CDB, CDEB, DI, DDE, DME 工具: T245, T245G, T245P, T245N
<b>C245708</b>	凿型烙铁头 4.8 x 1.5 mm HT S2		通用焊接	焊台: CDB, CDEB, DI, DDE, DME 工具: T245, T245G, T245P, T245N

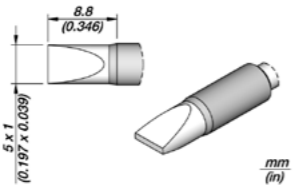
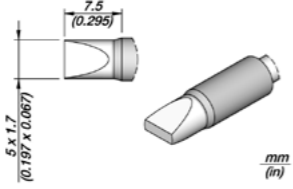
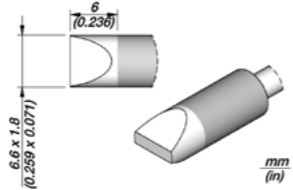

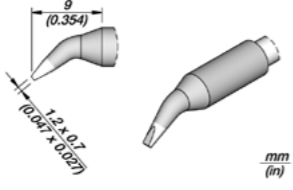
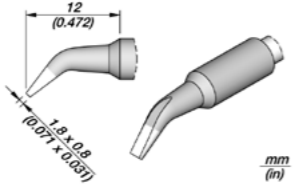
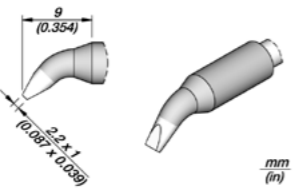
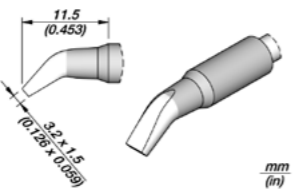
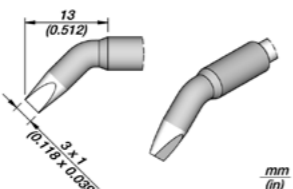
C245 系列烙铁头— T245 通用型手柄

产品料号	产品规格	产品图片	推荐用途	搭配产品
	<b>C245967</b> 凿型烙铁头 5 x 1 mm HT		通用焊接	焊台: CDB, CDEB, DI, DDE, DME 工具: T245, T245G, T245P, T245N
<b>C245069</b>	凿型烙铁头 5 x 1.7 mm HT		通用焊接	焊台: CDB, CDEB, DI, DDE, DME 工具: T245, T245G, T245P, T245N
<b>C245966</b>	凿型烙铁头 6.6 x 1.8 mm HT		通用焊接	焊台: CDB, CDEB, DI, DDE, DME 工具: T245, T245G, T245P, T245N
	<b>C245962</b> 凿弯型烙铁头 1.2 x 0.7 mm		通用焊接	焊台: CDB, CDEB, DI, DDE, DME 工具: T245, T245G, T245P, T245N
<b>C245963</b>	凿弯型烙铁头 1.8 x 0.8 mm		通用焊接	焊台: CDB, CDEB, DI, DDE, DME 工具: T245, T245G, T245P, T245N
<b>C245946</b>	凿弯型烙铁头 2.2 x 1 mm		通用焊接	焊台: CDB, CDEB, DI, DDE, DME 工具: T245, T245G, T245P, T245N
<b>C245732</b>	凿弯型烙铁头 3.2 x 1.5 mm		通用焊接	焊台: CDB, CDEB, DI, DDE, DME 工具: T245, T245G, T245P, T245N
<b>C245761</b>	凿弯型烙铁头 3 x 1 mm		通用焊接	焊台: CDB, CDEB, DI, DDE, DME 工具: T245, T245G, T245P, T245N

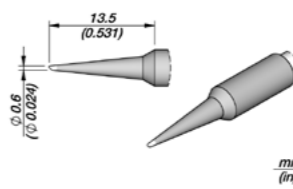
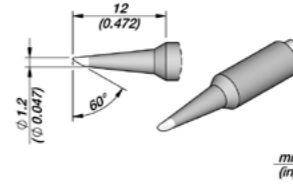
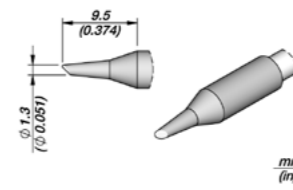
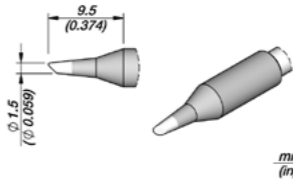
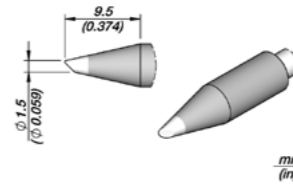
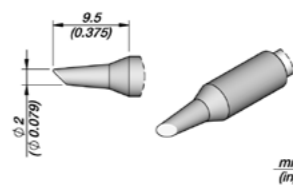
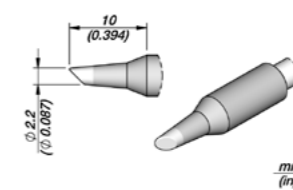
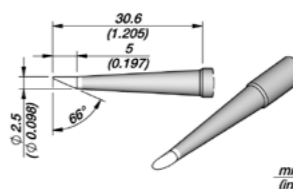
C245 系列烙铁头— T245 通用型手柄

产品料号	产品规格	产品图片	推荐用途	搭配产品
	<b>C245747</b> 斜面烙铁头 Ø 0.6 mm		0603 元件 穿孔焊接	焊台: CDB, CDEB, DI, DDE, DME 工具: T245, T245G, T245P, T245N
<b>C245710</b>	斜面烙铁头 Ø 1.2 mm		穿孔拖焊	焊台: CDB, CDEB, DI, DDE, DME 工具: T245, T245G, T245P, T245N
<b>C245064</b>	斜面烙铁头 Ø 1.3 mm		穿孔拖焊 仅焊嘴斜面镀锡, 点焊更精准。	焊台: CDB, CDEB, DI, DDE, DME 工具: T245, T245G, T245P, T245N
<b>C245905</b>	斜面烙铁头 Ø 1.5 mm		穿孔拖焊	焊台: CDB, CDEB, DI, DDE, DME 工具: T245, T245G, T245P, T245N
<b>C245405</b>	斜面烙铁头 Ø 1.5 mm HT		穿孔拖焊	焊台: CDB, CDEB, DI, DDE, DME 工具: T245, T245G, T245P, T245N
<b>C245102</b>	斜面烙铁头 Ø 2 mm		穿孔拖焊 仅焊嘴斜面镀锡, 点焊更精准。	焊台: CDB, CDEB, DI, DDE, DME 工具: T245, T245G, T245P, T245N
<b>C245945</b>	斜面烙铁头 Ø 2.2 mm		穿孔拖焊	焊台: CDB, CDEB, DI, DDE, DME 工具: T245, T245G, T245P, T245N
<b>C245795</b>	斜面烙铁头 Ø 2.5 mm L		穿孔拖焊	焊台: CDB, CDEB, DI, DDE, DME 工具: T245, T245G, T245P, T245N

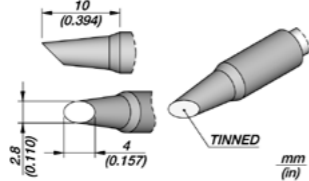
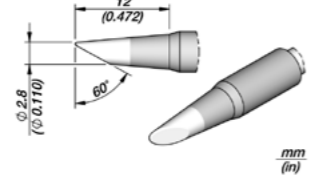
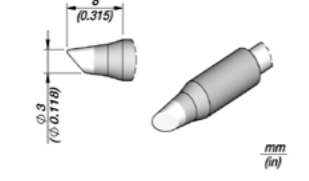
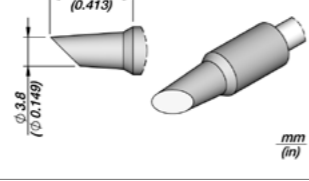
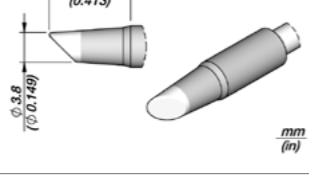
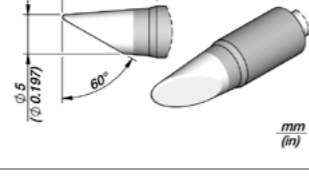
C245 系列烙铁头— T245 通用型手柄

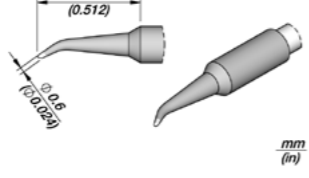
	产品料号	产品规格	产品图片	推荐用途	搭配产品
	<b>C245784</b>	斜面烙铁头 Ø 2.8 mm		穿孔拖焊	焊台: CDB, CDEB, DI, DDE, DME 工具: T245, T245G, T245P, T245N
	<b>C245793</b>	斜面烙铁头 Ø 2.8 mm - 60° - 60°		穿孔拖焊	焊台: CDB, CDEB, DI, DDE, DME 工具: T245, T245G, T245P, T245N
	<b>C245912</b>	斜面烙铁头 Ø 3 mm		穿孔拖焊	焊台: CDB, CDEB, DI, DDE, DME 工具: T245, T245G, T245P, T245N
	<b>C245056</b>	斜面烙铁头 Ø 3.5 mm HT		穿孔拖焊	焊台: CDB, CDEB, DI, DDE, DME 工具: T245, T245G, T245P, T245N
	<b>C245797</b>	斜面烙铁头 Ø 3.8 mm		仅焊嘴斜面镀锡, 点焊更精准。	焊台: CDB, CDEB, DI, DDE, DME 工具: T245, T245G, T245P, T245N
	<b>C245951</b>	斜面烙铁头 Ø 3.8 mm HT		穿孔拖焊	焊台: CDB, CDEB, DI, DDE, DME 工具: T245, T245G, T245P, T245N
	<b>C245766</b>	斜面烙铁头 Ø 5 mm		宽斜面镀锡	焊台: CDB, CDEB, DI, DDE, DME 工具: T245, T245G, T245P, T245N
	<b>C245748</b>	斜面弯型烙铁头 Ø 0.6 mm S1		0603 元件 穿孔焊接	焊台: CDB, CDEB, DI, DDE, DME 工具: T245, T245G, T245P, T245N

C245 系列烙铁头— T245 通用型手柄



	产品料号	产品规格	产品图片	推荐用途	搭配产品
	<b>C245749</b>	斜面弯型烙铁头 Ø 0.6 mm S2		0603 元件 穿孔焊接	焊台: CDB, CDEB, DI, DDE, DME 工具: T245, T245G, T245P, T245N
	<b>C245965</b>	勺型烙铁头 Ø 1.9 mm		拖焊焊接	焊台: CDB, CDEB, DI, DDE, DME 工具: T245, T245G, T245P, T245N
	<b>C245067</b>	勺型烙铁头 Ø 2.3 mm		拖焊焊接	焊台: CDB, CDEB, DI, DDE, DME 工具: T245, T245G, T245P, T245N
	<b>C245931</b>	勺型烙铁头 Ø 2.7 mm		拖焊焊接	焊台: CDB, CDEB, DI, DDE, DME 工具: T245, T245G, T245P, T245N
	<b>C245938</b>	勺型烙铁头 Ø 3.8 mm		拖焊焊接	焊台: CDB, CDEB, DI, DDE, DME 工具: T245, T245G, T245P, T245N
	<b>C245790</b>	U型烙铁头 Ø 0.8 mm		穿孔线材焊接及拆焊	焊台: CDB, CDEB, DI, DDE, DME 工具: T245, T245G, T245P, T245N
	<b>C245785</b>	U型烙铁头 Ø 1.5 mm		穿孔线材焊接及拆焊	焊台: CDB, CDEB, DI, DDE, DME 工具: T245, T245G, T245P, T245N
	<b>C245763</b>	U型烙铁头 Ø 2.5 mm		穿孔线材焊接及拆焊	焊台: CDB, CDEB, DI, DDE, DME 工具: T245, T245G, T245P, T245N



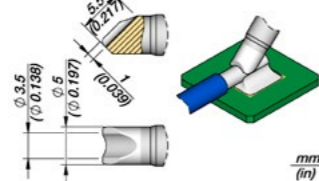
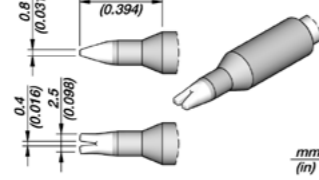
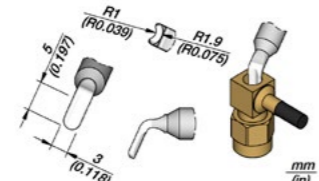
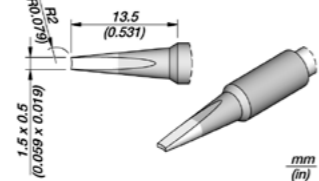
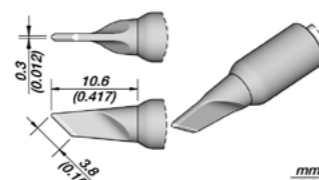

C245 系列烙铁头— T245 通用型手柄

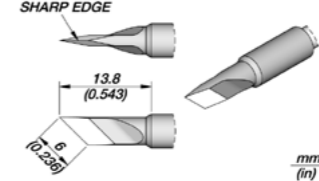
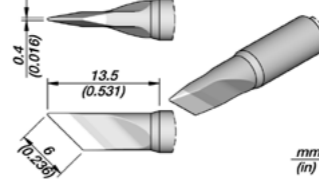
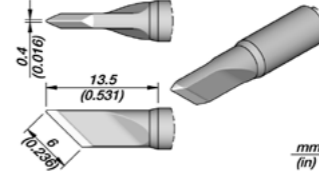
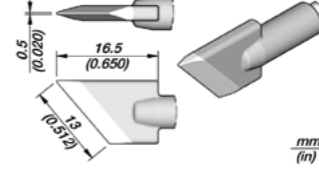
产品料号	产品规格	产品图片	推荐用途	搭配产品
	<b>C245760</b> U型烙铁头 Ø 3.5 mm		穿孔线材焊接及拆焊	焊台: CDB, CDEB, DI, DDE, DME 工具: T245, T245G, T245P, T245N
	<b>C245118</b> 引线/导线专用 烙铁头 0.4 mm		穿孔线缆镀锡专用	焊台: CDB, CDEB, DI, DDE, DME 工具: T245, T245G, T245P, T245N
<b>C245117</b>	引线/连接器专用烙 铁头 Ø 1.4 mm		穿孔焊接	焊台: CDB, CDEB, DI, DDE, DME 工具: T245, T245G, T245P, T245N
<b>C245116</b>	引线/连接器专用烙 铁头 R. 1 mm		穿孔同轴电缆焊接	焊台: CDB, CDEB, DI, DDE, DME 工具: T245, T245G, T245P, T245N
<b>C245122</b>	引线/连接器专用烙 铁头 1.5 x 0.5 mm		圆柱形零件	焊台: CDB, CDEB, DI, DDE, DME 工具: T245, T245G, T245P, T245N
<b>C245762</b>	柱状引脚烙铁头 R. 4.5 mm		线材焊接及拆焊	焊台: CDB, CDEB, DI, DDE, DME 工具: T245, T245G, T245P, T245N
	<b>C245789</b> 刀型烙铁头 3.8 x 0.3 mm		拖焊焊接	焊台: CDB, CDEB, DI, DDE, DME 工具: T245, T245G, T245P, T245N
<b>C245941</b>	刀型烙铁头 6 x 0.3 mm		拖焊焊接	焊台: CDB, CDEB, DI, DDE, DME 工具: T245, T245G, T245P, T245N

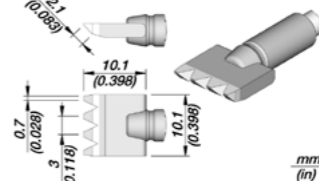
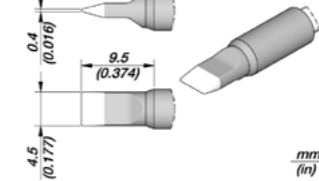
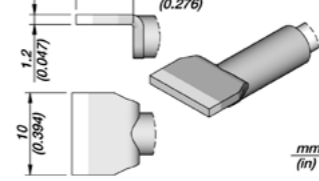
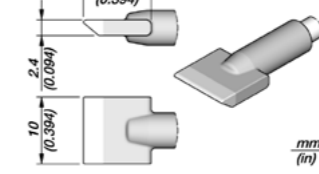

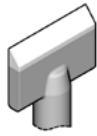
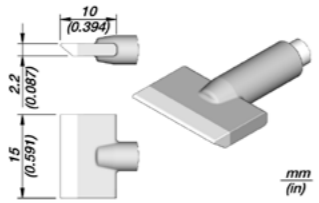
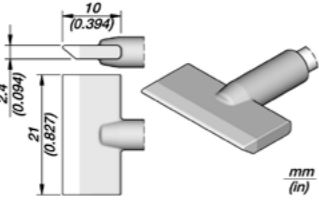
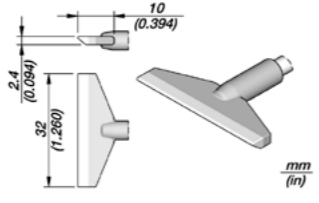
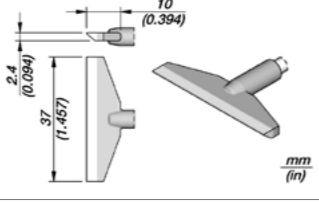
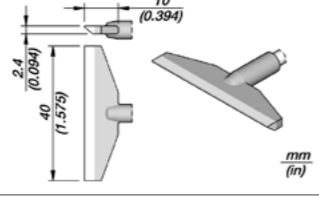

C245 系列烙铁头— T245 通用型手柄

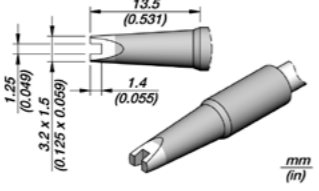
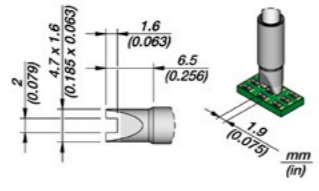
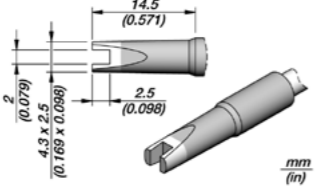
产品料号	产品规格	产品图片	推荐用途	搭配产品
	<b>C245940</b> 刀型烙铁头 6.0 x 0.1 mm		拖焊焊接	焊台: CDB, CDEB, DI, DDE, DME 工具: T245, T245G, T245P, T245N
<b>C245939</b>	刀型烙铁头 6.0 x 0.4 mm		拖焊焊接	焊台: CDB, CDEB, DI, DDE, DME 工具: T245, T245G, T245P, T245N
<b>C245765</b>	刀型烙铁头 6.0 x 0.4 mm S1		拖焊焊接	焊台: CDB, CDEB, DI, DDE, DME 工具: T245, T245G, T245P, T245N
<b>C245955</b>	刀型烙铁头 13 x 0.5 mm		拖焊焊接 连接器拆焊	焊台: CDB, CDEB, DI, DDE, DME 工具: T245, T245G, T245P, T245N
	<b>C245728</b> 锯齿铲型烙铁头 10.1 mm		连接器焊接及拆焊	焊台: CDB, CDEB, DI, DDE, DME 工具: T245, T245G, T245P, T245N
<b>C245799</b>	铲型烙铁头 4.5 mm		焊盘清理专用 连接器拆焊	焊台: CDB, CDEB, DI, DDE, DME 工具: T245, T245G, T245P, T245N
<b>C245730</b>	铲型烙铁头 10 mm S2		焊盘清理专用 连接器拆焊	焊台: CDB, CDEB, DI, DDE, DME 工具: T245, T245G, T245P, T245N
<b>C245914</b>	铲型烙铁头 10 mm S1		焊盘清理专用 连接器拆焊	焊台: CDB, CDEB, DI, DDE, DME 工具: T245, T245G, T245P, T245N

C245 系列烙铁头—T245 通用型手柄

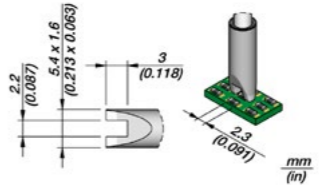
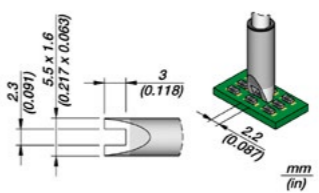
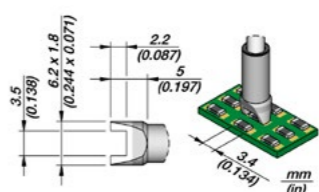
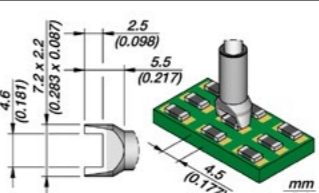
产品料号	产品规格	产品图片	推荐用途	搭配产品
 <b>C245752</b>	铲型烙铁头 15 mm		焊盘清理专用 连接器拆焊	焊台: CDB, CDEB, DI, DDE, DME 工具: T245, T245G, T245P, T245N
<b>C245913</b>	铲型烙铁头 21 mm		焊盘清理专用 连接器拆焊	焊台: CDB, CDEB, DI, DDE, DME 工具: T245, T245G, T245P, T245N
<b>C245949</b>	铲型烙铁头 32 mm		焊盘清理专用 连接器拆焊	焊台: CDB, CDEB, DI, DDE, DME 工具: T245, T245G, T245P, T245N
<b>C245776</b>	铲型烙铁头 37 mm		焊盘清理专用 连接器拆焊	焊台: CDB, CDEB, DI, DDE, DME 工具: T245, T245G, T245P, T245N
<b>C245792</b>	铲型烙铁头 40 mm		焊盘清理专用 连接器拆焊	焊台: CDB, CDEB, DI, DDE, DME 工具: T245, T245G, T245P, T245N
 <b>C245757</b>	芯片烙铁头 1.25 mm		SMD电阻器 SMD电容器	焊台: CDB, CDEB, DI, DDE, DME 工具: T245, T245G, T245P, T245N
<b>C245016</b>	芯片烙铁头 1.9 mm		SMD电阻器 SMD电容器	焊台: CDB, CDEB, DI, DDE, DME 工具: T245, T245G, T245P, T245N
<b>C245758</b>	芯片烙铁头 2 mm		SMD电阻器 SMD电容器	焊台: CDB, CDEB, DI, DDE, DME 工具: T245, T245G, T245P, T245N

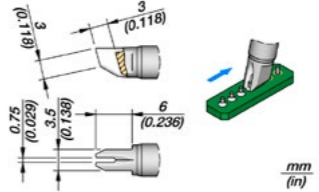
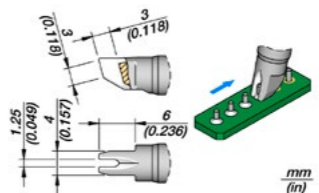
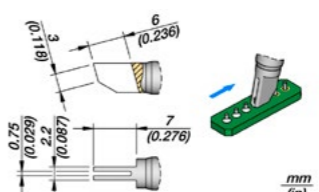
C245 系列烙铁头—T245 通用型手柄

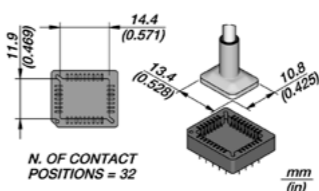
产品料号	产品规格	产品图片	推荐用途	搭配产品
 <b>C245017</b>	芯片烙铁头 2.3 mm S1		SMD电阻器 SMD电容器	焊台: CDB, CDEB, DI, DDE, DME 工具: T245, T245G, T245P, T245N
<b>C245150</b>	芯片烙铁头 2.2 mm S2		SMD电阻器 SMD电容器	焊台: CDB, CDEB, DI, DDE, DME 工具: T245, T245G, T245P, T245N
<b>C245018</b>	芯片烙铁头 3.4 mm		SMD电阻器 SMD电容器	焊台: CDB, CDEB, DI, DDE, DME 工具: T245, T245G, T245P, T245N
<b>C245019</b>	芯片烙铁头 4.5 mm		SMD电阻器 SMD电容器	焊台: CDB, CDEB, DI, DDE, DME 工具: T245, T245G, T245P, T245N
 <b>C245754</b>	拖焊烙铁头 0.75 mm		拖焊焊接	焊台: CDB, CDEB, DI, DDE, DME 工具: T245, T245G, T245P, T245N
<b>C245751</b>	拖焊烙铁头 1.25 mm		拖焊焊接	焊台: CDB, CDEB, DI, DDE, DME 工具: T245, T245G, T245P, T245N
<b>C245796</b>	拖焊烙铁头 2.2 x 0.75 mm		拖焊焊接	焊台: CDB, CDEB, DI, DDE, DME 工具: T245, T245G, T245P, T245N
 <b>C245248</b>	插孔烙铁头 11.9 x 14.4 mm		焊接PLCC插孔	焊台: CDB, CDEB, DI, DDE, DME 工具: T245, T245G, T245P, T245N

C245 系列烙铁头— T245 通用型手柄

产品料号	产品规格	产品图片	推荐用途	搭配产品
<b>C245247</b>	插孔烙铁头 17 x 17 mm		焊接PLCC插孔	焊台: CDB, CDEB, DI, DDE, DME 工具: T245, T245G, T245P, T245N
<b>C245SP01</b>	锡炉烙铁头 15 x 18 mm		线缆上锡; 多芯元器件 锡焊穿孔拆焊。	焊台: CDB, CDEB, DI, DDE, DME 工具: T245, T245G, T245P, T245N
<b>C245163</b>	空心铆接烙铁头 Ø 2.5 mm		热焊压塑胶专用	焊台: CDB, CDEB, DI, DDE, DME 工具: T245, T245G, T245P, T245N
<b>C245688</b>	铆接弯型烙铁头 Ø 3.2 mm		热焊塑胶专用	焊台: CDB, CDEB, DI, DDE, DME 工具: T245, T245G, T245P, T245N
<b>C245166</b>	不锈钢热压塑料 烙铁头 Ø 1.7 mm		热焊塑胶专用	焊台: CDB, CDEB, DI, DDE, DME 工具: T245, T245G, T245P, T245N
<b>C245053</b>	铆接烙铁头 Ø 3.8 mm		镀铬, 为塑料铆钉设计	焊台: CDB, CDEB, DI, DDE, DME 工具: T245, T245G, T245P, T245N
<b>C245052</b>	铆接烙铁头 Ø 4.9 mm		镀铬, 为塑料铆钉设计	焊台: CDB, CDEB, DI, DDE, DME 工具: T245, T245G, T245P, T245N
<b>C245054</b>	铆接烙铁头 Ø 6.5 mm		镀铬, 为塑料铆钉设计	焊台: CDB, CDEB, DI, DDE, DME 工具: T245, T245G, T245P, T245N

C245 系列烙铁头— T245 通用型手柄

产品料号	产品规格	产品图片	推荐用途	搭配产品
<b>C245143</b>	双铆接烙铁头 Ø 1.8 mm		镀铬, 为塑料铆钉设计	焊台: CDB, CDEB, DI, DDE, DME 工具: T245, T245G, T245P, T245N
<b>C245798</b>	铆接烙铁头 Ø 8 mm		镀铬, 为塑料铆钉设计	焊台: CDB, CDEB, DI, DDE, DME 工具: T245, T245G, T245P, T245N
<b>C245791</b>	铆接烙铁头 Ø 9.8 mm		镀铬, 为塑料铆钉设计	焊台: CDB, CDEB, DI, DDE, DME 工具: T245, T245G, T245P, T245N
<b>C245312</b>	铆接烙铁头 Ø 3.2 mm		热焊塑胶专用	焊台: CDB, CDEB, DI, DDE, DME 工具: T245, T245G, T245P, T245N
<b>C245313</b>	铆接烙铁头 Ø 4.1 mm		热焊塑胶专用	焊台: CDB, CDEB, DI, DDE, DME 工具: T245, T245G, T245P, T245N
<b>C245124</b>	铆接烙铁头 4.25 x 2 mm		热焊塑胶专用	焊台: CDB, CDEB, DI, DDE, DME 工具: T245, T245G, T245P, T245N
<b>C245123</b>	铆接烙铁头 4 x 4 mm		热焊塑胶专用	焊台: CDB, CDEB, DI, DDE, DME 工具: T245, T245G, T245P, T245N
<b>C245168</b>	塑料热压钻孔 烙铁头 Ø 3.1 mm		热焊塑胶专用	焊台: CDB, CDEB, DI, DDE, DME 工具: T245, T245G, T245P, T245N
<b>C245167</b>	塑料热压钻孔 烙铁头 Ø 2.1 mm		热焊塑胶专用	焊台: CDB, CDEB, DI, DDE, DME 工具: T245, T245G, T245P, T245N

C245 系列烙铁头— T245 通用型手柄

产品料号	产品规格	产品图片	推荐用途	搭配产品
<b>C245311</b>	铆接烙铁头 20 x 6 mm		热焊塑胶专用	焊台: CDB, CDEB, DI, DDE, DME 工具: T245, T245G, T245P, T245N
<b>C245109</b>	除胶烙铁头 4.3 x 0.1 mm		去除三防胶涂膜专用	焊台: CDB, CDEB, DI, DDE, DME 工具: T245, T245G, T245P, T245N
<b>C245138</b>	切割用烙铁头 12 mm		切割塑料橡胶专用	焊台: CDB, CDEB, DI, DDE, DME 工具: T245, T245G, T245P, T245N
<b>C245121</b>	切割用烙铁头 13 mm		切割塑料橡胶专用	焊台: CDB, CDEB, DI, DDE, DME 工具: T245, T245G, T245P, T245N
<b>C245764</b>	细距焊接烙铁头 Ø 0.5 mm		0603 元件 QFP, IC 缝距	焊台: CDB, CDEB, DI, DDE, DME 工具: T245, T245G, T245P, T245N
<b>C245119</b>	圆锥型特氟龙 烙铁头 Ø 1 mm		热焊塑胶专用	焊台: CDB, CDEB, DI, DDE, DME 工具: T245, T245G, T245P, T245N
<b>C245771</b>	弯型烙铁头 1 x 0.1 mm		连接器细缝距焊接	焊台: CDB, CDEB, DI, DDE, DME 工具: T245, T245G, T245P, T245N
<b>C245772</b>	镀镍烙铁头 Ø 1.4 x 0.7 mm S1		高熔点焊接专用	焊台: CDB, CDEB, DI, DDE, DME 工具: T245, T245G, T245P, T245N
<b>C245268</b>	引线/导线专用烙 铁头 1.5 mm		穿孔焊接	焊台: CDB, CDEB, DI, DDE, DME 工具: T245, T245G, T245P, T245N

C245 系列烙铁头— T245 通用型手柄

产品料号	产品规格	产品图片	推荐用途	搭配产品
<b>C245010</b>	J型引脚专用烙铁头 4.4 x 1.8 mm		J型引脚拖焊焊接	焊台: CDB, CDEB, DI, DDE, DME 工具: T245, T245G, T245P, T245N
<b>C245009</b>	S型引脚专用烙铁头 4.5 x 1.8 mm		拖焊焊接	焊台: CDB, CDEB, DI, DDE, DME 工具: T245, T245G, T245P, T245N
<b>C245136</b>	微型贴片开关专用 烙铁头 7.1 x 6.5 mm		微型操纵杆开关拆焊专用	焊台: CDB, CDEB, DI, DDE, DME 工具: T245, T245G, T245P, T245N

C245L 加长型系列烙铁头- T245通用型手柄

C245L烙铁头加长20mm,更易到达难以触及的焊接处。

产品料号	产品规格	产品图片	推荐用途	搭配产品
<b>C245230</b>	圆锥型烙铁头 Ø 0.3 mm L		通用焊接	焊台: CDB, CDEB, DI, DDE, DME 工具: T245, T245G, T245P, T245N
<b>C245201</b>	圆锥型烙铁头 Ø 0.6 mm L		0603 元件 QFP, IC	焊台: CDB, CDEB, DI, DDE, DME 工具: T245, T245G, T245P, T245N
<b>C245803</b>	圆锥型烙铁头 Ø 1 mm L		通用焊接	焊台: CDB, CDEB, DI, DDE, DME 工具: T245, T245G, T245P, T245N
<b>C245234</b>	圆锥弯型烙铁头 Ø 0.4 mm S1 L		0201、0402 元件 0.65 mm 缝距 QFP, IC	焊台: CDB, CDEB, DI, DDE, DME 工具: T245, T245G, T245P, T245N











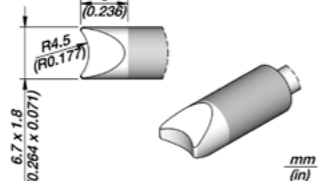

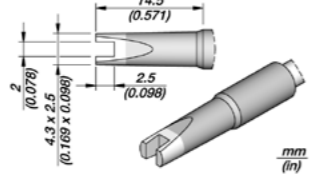

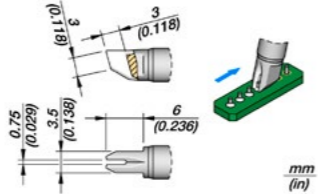
C245L 加长型系列烙铁头- T245通用型手柄

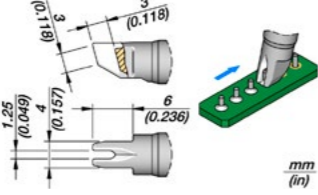
产品料号	产品规格	产品图片	推荐用途	搭配产品
<b>C245804</b>	圆锥弯型烙铁头 Ø 1 mm L		通用焊接	焊台: CDB, CDEB, DI, DDE, DME 工具: T245, T245G, T245P, T245N
<b>C245673</b>	凿型烙铁头 0.8 x 0.3 mm L		0805 元件 穿孔焊接	焊台: CDB, CDEB, DI, DDE, DME 工具: T245, T245G, T245P, T245N
<b>C245806</b>	凿型烙铁头 1.2 x 0.7 mm L		通用焊接	焊台: CDB, CDEB, DI, DDE, DME 工具: T245, T245G, T245P, T245N
<b>C245844</b>	凿型烙铁头 1.8 x 0.8 mm L		通用焊接	焊台: CDB, CDEB, DI, DDE, DME 工具: T245, T245G, T245P, T245N
<b>C245807</b>	凿型烙铁头 2.2 x 1 mm L		通用焊接	焊台: CDB, CDEB, DI, DDE, DME 工具: T245, T245G, T245P, T245N
<b>C245261</b>	凿型烙铁头 3 x 1 mm L		通用焊接	焊台: CDB, CDEB, DI, DDE, DME 工具: T245, T245G, T245P, T245N
<b>C245811</b>	凿型烙铁头 3.2 x 1.2 mm L		通用焊接	焊台: CDB, CDEB, DI, DDE, DME 工具: T245, T245G, T245P, T245N
<b>C245808</b>	凿型烙铁头 4.8 x 1.5 mm HT L		通用焊接	焊台: CDB, CDEB, DI, DDE, DME 工具: T245, T245G, T245P, T245N

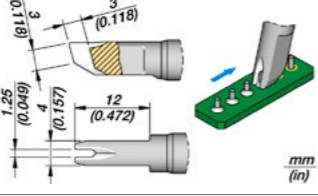

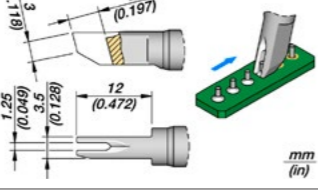

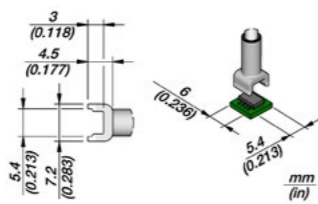

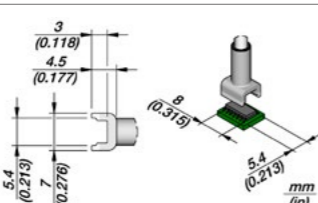



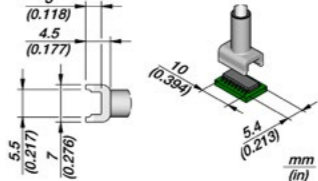

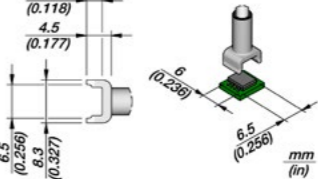

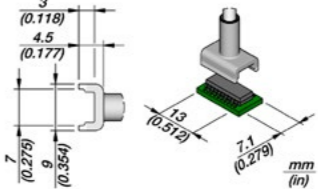
C245L 加长型系列烙铁头- T245通用型手柄

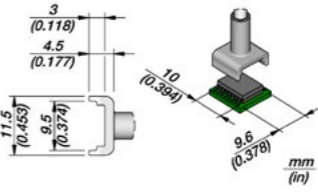
产品料号	产品规格	产品图片	推荐用途	搭配产品
<b>C245866</b>	凿型烙铁头 6.6 x 1.8 mm HT L		通用焊接	焊台: CDB, CDEB, DI, DDE, DME 工具: T245, T245G, T245P, T245N
<b>C245862</b>	凿弯型烙铁头 1.2 x 0.7 mm L		通用焊接	焊台: CDB, CDEB, DI, DDE, DME 工具: T245, T245G, T245P, T245N
<b>C245863</b>	凿弯型烙铁头 1.8 x 0.8 mm L		通用焊接	焊台: CDB, CDEB, DI, DDE, DME 工具: T245, T245G, T245P, T245N
<b>C245846</b>	凿弯型烙铁头 2.2 x 1 mm L		通用焊接	焊台: CDB, CDEB, DI, DDE, DME 工具: T245, T245G, T245P, T245N
<b>C245845</b>	斜面烙铁头 Ø 2.2 mm L		穿孔拖焊	焊台: CDB, CDEB, DI, DDE, DME 工具: T245, T245G, T245P, T245N
<b>C245812</b>	斜面烙铁头 Ø 3 mm L		穿孔拖焊	焊台: CDB, CDEB, DI, DDE, DME 工具: T245, T245G, T245P, T245N
<b>C245256</b>	斜面烙铁头 Ø 3.5 mm HT L		穿孔拖焊	焊台: CDB, CDEB, DI, DDE, DME 工具: T245, T245G, T245P, T245N
<b>C245301</b>	斜面烙铁头 Ø 8.8 mm		宽斜面镀锡	焊台: CDB, CDEB, DI, DDE, DME 工具: T245, T245G, T245P, T245N

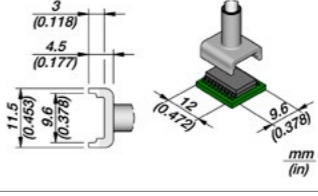
C245L 加长型系列烙铁头- T245通用型手柄

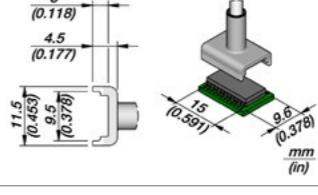
产品料号	产品规格	产品图片	推荐用途	搭配产品
 <b>C245662</b>	柱状引脚烙铁头 R. 4.5 mm L		线材焊接及拆焊	焊台: CDB, CDEB, DI, DDE, DME 工具: T245, T245G, T245P, T245N
 <b>C245658</b>	芯片烙铁头 2.0 mm L		SMD电阻器 SMD电容器	焊台: CDB, CDEB, DI, DDE, DME 工具: T245, T245G, T245P, T245N
 <b>C245654</b>	拖焊烙铁头 0.75 mm L		拖焊焊接	焊台: CDB, CDEB, DI, DDE, DME 工具: T245, T245G, T245P, T245N
 <b>C245651</b>	拖焊烙铁头 1.25 mm L		拖焊焊接	焊台: CDB, CDEB, DI, DDE, DME 工具: T245, T245G, T245P, T245N
 <b>C245667</b>	拖焊烙铁头 1.25 mm S1 L		拖焊焊接	焊台: CDB, CDEB, DI, DDE, DME 工具: T245, T245G, T245P, T245N
 <b>C245669</b>	拖焊烙铁头 1.25 mm S2 L		拖焊焊接	焊台: CDB, CDEB, DI, DDE, DME 工具: T245, T245G, T245P, T245N
 <b>C245220</b>	双排直列烙铁头 5.4 x 6 mm		双列直插IC封装	焊台: CDB, CDEB, DI, DDE, DME 工具: T245, T245G, T245P, T245N
 <b>C245250</b>	双排直列烙铁头 5.4 x 8 mm		双列直插IC封装	焊台: CDB, CDEB, DI, DDE, DME 工具: T245, T245G, T245P, T245N

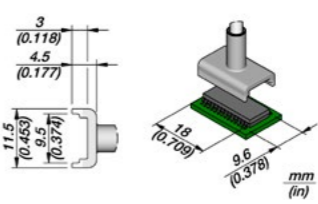
C245L 加长型系列烙铁头- T245通用型手柄

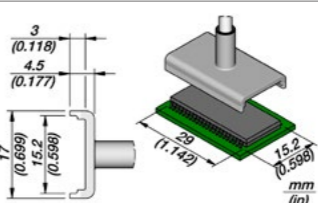
产品料号	产品规格	产品图片	推荐用途	搭配产品
 <b>C245221</b>	双排直列烙铁头 5.4 x 10 mm		双列直插IC封装	焊台: CDB, CDEB, DI, DDE, DME 工具: T245, T245G, T245P, T245N
 <b>C245303</b>	双排直列烙铁头 6.5 x 6 mm		双列直插IC封装	焊台: CDB, CDEB, DI, DDE, DME 工具: T245, T245G, T245P, T245N
 <b>C245222</b>	双排直列烙铁头 7.1 x 13 mm		双列直插IC封装	焊台: CDB, CDEB, DI, DDE, DME 工具: T245, T245G, T245P, T245N
 <b>C245306</b>	双排直列烙铁头 9.6 x 10 mm		双列直插IC封装	焊台: CDB, CDEB, DI, DDE, DME 工具: T245, T245G, T245P, T245N
 <b>C245305</b>	双排直列烙铁头 9.6 x 12 mm		双列直插IC封装	焊台: CDB, CDEB, DI, DDE, DME 工具: T245, T245G, T245P, T245N
 <b>C245304</b>	双排直列烙铁头 9.6 x 15 mm		Dual in Line, IC	焊台: CDB, CDEB, DI, DDE, DME 工具: T245, T245G, T245P, T245N
 <b>C245215</b>	双排直列烙铁头 9.6 x 18 mm		双列直插IC封装	焊台: CDB, CDEB, DI, DDE, DME 工具: T245, T245G, T245P, T245N
 <b>C245226</b>	双排直列烙铁头 15.2 x 29 mm		双列直插IC封装	焊台: CDB, CDEB, DI, DDE, DME 工具: T245, T245G, T245P, T245N



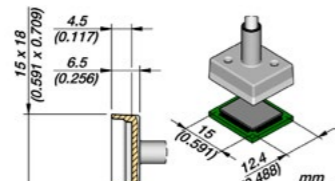
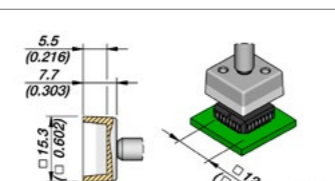
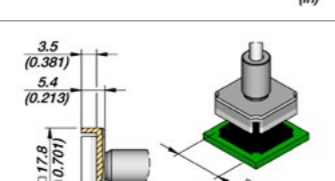
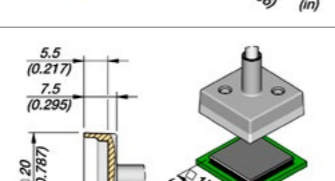
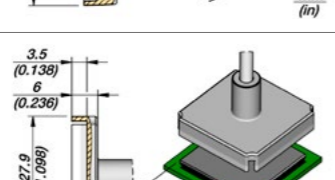

C245L 加长型系列烙铁头- T245通用型手柄

产品料号	产品规格	产品图片	推荐用途	搭配产品
 <b>C245223</b>	QFP拆焊烙铁头 8.5 x 8.5 mm		QFP	焊台: CDB, CDEB, DI, DDE, DME 工具: T245, T245G, T245P, T245N
<b>C245224</b>	QFP拆焊烙铁头 12 x 12 mm		QFP	焊台: CDB, CDEB, DI, DDE, DME 工具: T245, T245G, T245P, T245N
<b>C245228</b>	QFP拆焊烙铁头 12.4 x 15 mm		QFP	焊台: CDB, CDEB, DI, DDE, DME 工具: T245, T245G, T245P, T245N
<b>C245351</b>	QFP拆焊烙铁头 12.3 x 12.3 mm		QFP	焊台: CDB, CDEB, DI, DDE, DME 工具: T245, T245G, T245P, T245N
<b>C245315</b>	QFP拆焊烙铁头 15 x 15 mm		QFP	焊台: CDB, CDEB, DI, DDE, DME 工具: T245, T245G, T245P, T245N
<b>C245352</b>	QFP拆焊烙铁头 15.4 x 15.4 mm		QFP	焊台: CDB, CDEB, DI, DDE, DME 工具: T245, T245G, T245P, T245N
<b>C245227</b>	QFP拆焊烙铁头 17.5 x 17.5 mm		QFP	焊台: CDB, CDEB, DI, DDE, DME 工具: T245, T245G, T245P, T245N
<b>C245344</b>	QFP拆焊烙铁头 26 x 26 mm		QFP	焊台: CDB, CDEB, DI, DDE, DME 工具: T245, T245G, T245P, T245N

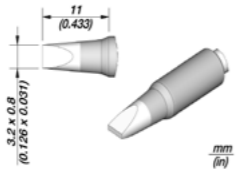
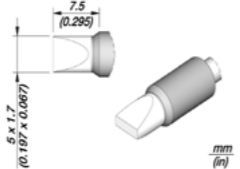
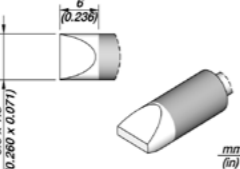

C245E 延长寿命系列烙铁头— T245 通用型手柄

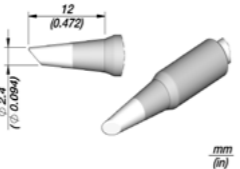
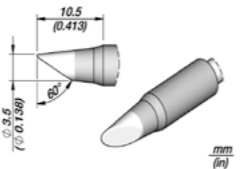
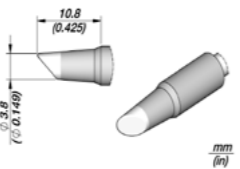
产品料号	产品规格	产品图片	推荐用途	搭配产品
 <b>C245736E</b>	圆锥型烙铁头 Ø 1 mm		通用焊接	焊台: CDB, CDEB, DI, DDE, DME 工具: T245, T245G, T245P, T245N
 <b>C245909E</b>	圆锥弯型烙铁头 Ø 1 mm		通用焊接	焊台: CDB, CDEB, DI, DDE, DME 工具: T245, T245G, T245P, T245N
<b>C245629E</b>	圆锥弯型烙铁头 Ø 4 mm		通用焊接	焊台: CDB, CDEB, DI, DDE, DME 工具: T245, T245G, T245P, T245N
 <b>C245159E</b>	凿型烙铁头 0.8 x 0.4 mm		通用焊接	焊台: CDB, CDEB, DI, DDE, DME 工具: T245, T245G, T245P, T245N
<b>C245158E</b>	凿型烙铁头 1.2 x 0.4 mm		通用焊接	焊台: CDB, CDEB, DI, DDE, DME 工具: T245, T245G, T245P, T245N
<b>C245160E</b>	凿型烙铁头 1.6 x 0.5 mm		通用焊接	焊台: CDB, CDEB, DI, DDE, DME 工具: T245, T245G, T245P, T245N
<b>C245155E</b>	凿型烙铁头 2.4 x 0.8 mm		通用焊接	焊台: CDB, CDEB, DI, DDE, DME 工具: T245, T245G, T245P, T245N
<b>C245735E</b>	凿型烙铁头 2.7 x 1 mm		通用焊接	焊台: CDB, CDEB, DI, DDE, DME 工具: T245, T245G, T245P, T245N

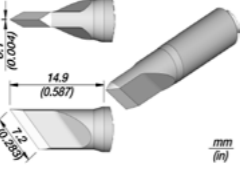
C245E 延长寿命系列烙铁头— T245 通用型手柄

产品料号	产品规格	产品图片	推荐用途	搭配产品
	<b>C245161E</b> 凿型烙铁头 3.2 x 0.8 mm		通用焊接	焊台: CDB, CDEB, DI, DDE, DME 工具: T245, T245G, T245P, T245N
<b>C245070E</b>	凿型烙铁头 5 x 1.7 mm		通用焊接	焊台: CDB, CDEB, DI, DDE, DME 工具: T245, T245G, T245P, T245N
<b>C245968E</b>	凿型烙铁头 6.6 x 1.8 mm		通用焊接	焊台: CDB, CDEB, DI, DDE, DME 工具: T245, T245G, T245P, T245N
	<b>C245156E</b> 斜面烙铁头 Ø 2.4 mm		拖焊焊接 穿孔焊接	焊台: CDB, CDEB, DI, DDE, DME 工具: T245, T245G, T245P, T245N
<b>C245354E</b>	斜面烙铁头 Ø 3.5 mm L		拖焊焊接 穿孔焊接	焊台: CDB, CDEB, DI, DDE, DME 工具: T245, T245G, T245P, T245N
<b>C245952E</b>	斜面烙铁头 Ø 3.8 mm		拖焊焊接 穿孔焊接	焊台: CDB, CDEB, DI, DDE, DME 工具: T245, T245G, T245P, T245N
	<b>C245157E</b> 刀型烙铁头 7.2 mm		拖焊焊接 穿孔焊接	焊台: CDB, CDEB, DI, DDE, DME 工具: T245, T245G, T245P, T245N

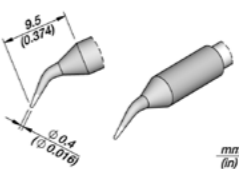
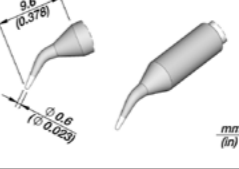
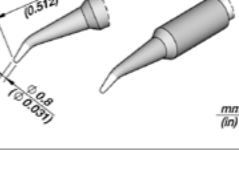
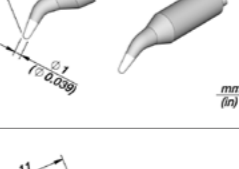
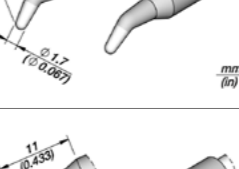
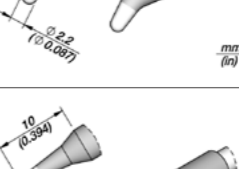

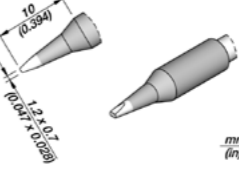
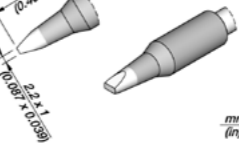

C250系列烙铁头— ALE250 自动送锡枪和 AP250送锡枪

产品料号	产品规格	产品图片	推荐用途	搭配产品
	<b>C250420</b> 圆锥弯型烙铁头 Ø 0.4 mm		0201, 0402 元件 0.65 mm 缝距 QFP, IC	焊台: ALE, CA 工具: ALE250, AP250
<b>C250401</b>	圆锥弯型烙铁头 Ø 0.6 mm		0603 元件 QFP, IC	焊台: ALE, CA 工具: ALE250, AP250
<b>C250402</b>	圆锥弯型烙铁头 Ø 0.8 mm		通用焊接	焊台: ALE, CA 工具: ALE250, AP250
<b>C250403</b>	圆锥弯型烙铁头 Ø 1 mm		通用焊接	焊台: ALE, CA 工具: ALE250, AP250
<b>C250409</b>	圆锥弯型烙铁头 Ø 1.7 mm		通用焊接	焊台: ALE, CA 工具: ALE250, AP250
<b>C250410</b>	圆锥弯型烙铁头 Ø 2.2 mm		通用焊接	焊台: ALE, CA 工具: ALE250, AP250
	<b>C250407</b> 凿型烙铁头 1.2 x 0.7 mm		通用焊接	焊台: ALE, CA 工具: ALE250, AP250
<b>C250408</b>	凿型烙铁头 2.2 x 1 mm S1		通用焊接	焊台: ALE, CA 工具: ALE250, AP250



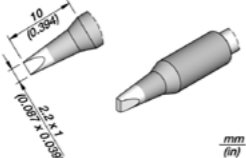
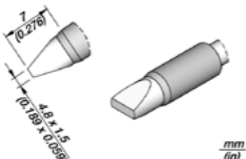

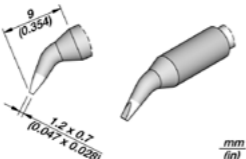
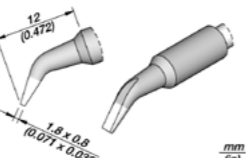
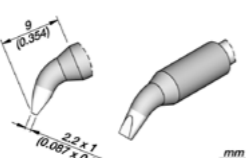
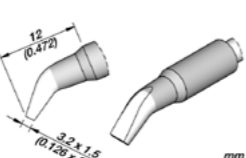
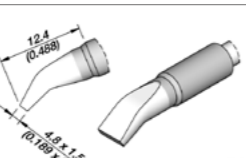
C250 系列烙铁头— ALE250 自动送锡枪和AP250送锡枪

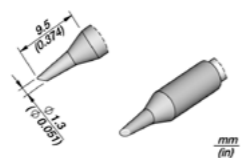
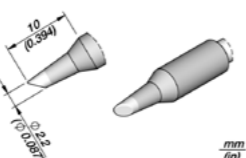
	产品料号	产品规格	产品图片	推荐用途	搭配产品
	<b>C250413</b>	凿型烙铁头 2.2 x 1 mm S2		通用焊接	焊台: ALE, CA 工具: ALE250, AP250
	<b>C250411</b>	凿型烙铁头 4.8 x 1.5 mm		通用焊接	焊台: ALE, CA 工具: ALE250, AP250
	<b>C250404</b>	凿弯型烙铁头 1.2 x 0.7 mm		通用焊接	焊台: ALE, CA 工具: ALE250, AP250
	<b>C250405</b>	凿弯型烙铁头 1.8 x 0.8 mm		通用焊接	焊台: ALE, CA 工具: ALE250, AP250
	<b>C250406</b>	凿弯型烙铁头 2.2 x 1 mm		通用焊接	焊台: ALE, CA 工具: ALE250, AP250
	<b>C250418</b>	凿弯型烙铁头 3.2 x 1.5 mm		通用焊接	焊台: ALE, CA 工具: ALE250, AP250
	<b>C250412</b>	凿弯型烙铁头 4.8 x 1.5 mm		通用焊接	焊台: ALE, CA 工具: ALE250, AP250
		<b>C250426</b>	斜面烙铁头 Ø 1.3 mm		穿孔拖焊
<b>C250414</b>		斜面烙铁头 Ø 2.2 mm		穿孔拖焊	焊台: ALE, CA 工具: ALE250, AP250

C250 系列烙铁头— ALE250 自动送锡枪和AP250送锡枪

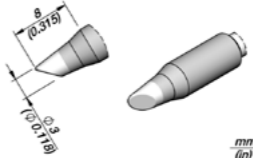
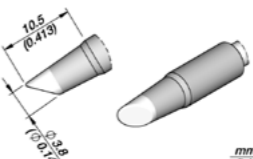
	产品料号	产品规格	产品图片	推荐用途	搭配产品
	<b>C250424</b>	斜面烙铁头 Ø 3 mm		穿孔拖焊	焊台: ALE, CA 工具: ALE250, AP250
	<b>C250415</b>	斜面烙铁头 Ø 3.8 mm		穿孔拖焊	焊台: ALE, CA 工具: ALE250, AP250

**C250E**延长寿命系列烙铁头- ALE250自动送锡枪和AP250送锡枪



C250E 烙铁头强化了对焊嘴的保护, 在延长使用寿命的同时极小地降低了热效率。

	产品料号	产品规格	产品图片	推荐用途	搭配产品
	<b>C250428E</b>	圆锥弯型烙铁头 Ø 1 mm		0201、0402 元件 0.65 mm 缝距 QFP, IC	焊台: ALE, CA 工具: ALE250, AP250
	<b>C250427E</b>	圆锥弯型烙铁头 Ø 4 mm		通用焊接	焊台: ALE, CA 工具: ALE250, AP250
	<b>C250432E</b>	凿型烙铁头 0.4 x 1.2 mm		通用焊接	焊台: ALE, CA 工具: ALE250, AP250
	<b>C250433E</b>	斜面烙铁头 Ø 2 mm		穿孔拖焊	焊台: ALE, CA 工具: ALE250, AP250
	<b>C250429E</b>	斜面烙铁头 Ø 3.8 mm		穿孔拖焊	焊台: ALE, CA 工具: ALE250, AP250

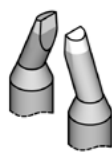
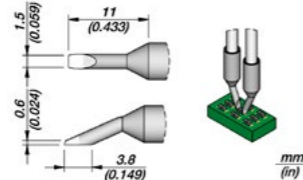
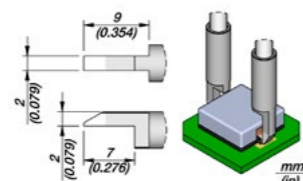
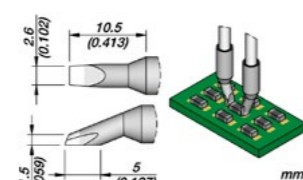
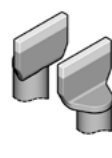
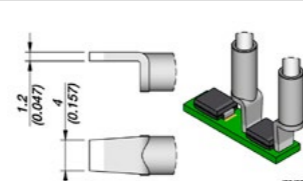
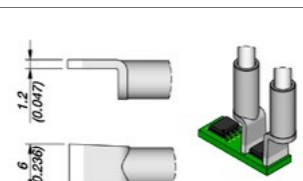
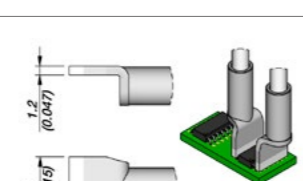
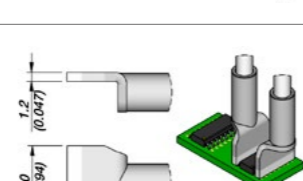
**C420系列烙铁头—AT420可调式导热镊夹和HT420导热镊夹**

产品料号	产品规格	产品图片	推荐用途	搭配产品
 <b>C420271</b>	芯片烙铁头 1.5 mm		SMD电阻器 SMD电容器	焊台: DI, DDE, DME 工具: AT420, HT420
<b>C420287</b>	芯片烙铁头 2 mm		SMD电阻器 SMD电容器	焊台: DI, DDE, DME 工具: AT420, HT420
<b>C420272</b>	芯片烙铁头 2.6 mm		SMD电阻器 SMD电容器	焊台: DI, DDE, DME 工具: AT420, HT420
 <b>C420273</b>	铲型双列烙铁头 4 mm		1210、1812 元件 SO, SOT DIP	焊台: DI, DDE, DME 工具: AT420, HT420
<b>C420274</b>	铲型双列烙铁头 6 mm		DIP IC	焊台: DI, DDE, DME 工具: AT420, HT420
<b>C420275</b>	铲型双列烙铁头 8 mm		DIP IC	焊台: DI, DDE, DME 工具: AT420, HT420
<b>C420276</b>	铲型双列烙铁头 10 mm		DIP IC	焊台: DI, DDE, DME 工具: AT420, HT420

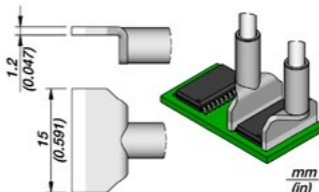
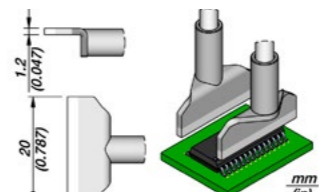
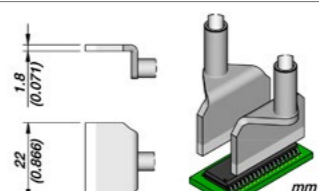
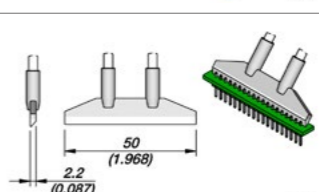
**C420系列烙铁头—AT420可调式导热镊夹和HT420导热镊夹**

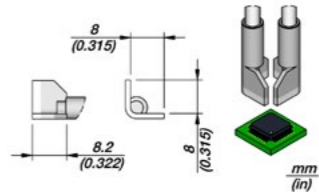
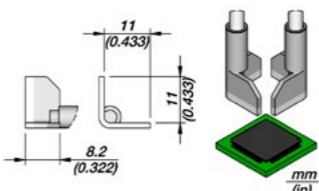
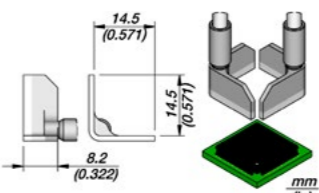
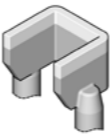
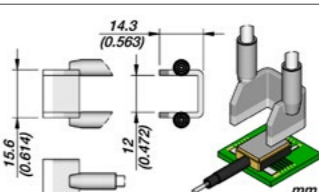
产品料号	产品规格	产品图片	推荐用途	搭配产品
 <b>C420277</b>	铲型双列烙铁头 15 mm		DIP IC	焊台: DI, DDE, DME 工具: AT420, HT420
<b>C420278</b>	铲型双列烙铁头 20 mm		DIP IC	焊台: DI, DDE, DME 工具: AT420, HT420
<b>C420285</b>	铲型双列烙铁头 22 mm		DIP IC	焊台: DI, DDE, DME 工具: AT420, HT420
<b>C420283</b>	铲型烙铁头 50 mm		焊盘清理专用 连接器拆焊	焊台: DI, DDE, DME 工具: AT420, HT420
 <b>C420279</b>	QFP专用烙铁头 8 mm		QFP PLCC	焊台: DI, DDE, DME 工具: AT420, HT420
<b>C420280</b>	QFP专用烙铁头 11 mm		QFP PLCC	焊台: DI, DDE, DME 工具: AT420, HT420
<b>C420288</b>	QFP专用烙铁头 14.5 mm		QFP PLCC	焊台: DI, DDE, DME 工具: AT420, HT420
 <b>C420286</b>	U型烙铁头 15.6 x 14.3 mm		定制	焊台: DI, DDE, DME 工具: AT420, HT420

**C470系列烙铁头— T470重负荷手柄和HT470重负荷导热镊夹**







产品料号	产品规格	产品图片	推荐用途	搭配产品
<b>C470001</b>	圆锥型烙铁头 Ø 1.7 mm		通用焊接	焊台: HDE 工具: T470, T470S, T470F, T470M, T470Z, T470N
<b>C470008</b>	圆锥弯型烙铁头 Ø 3.5 mm		通用焊接	焊台: HDE 工具: T470, T470S, T470F, T470M, T470Z, T470N
<b>C470013</b>	凿型烙铁头 2 x 0.9 mm		通用焊接	焊台: HDE 工具: T470, T470S, T470F, T470M, T470Z, T470N
<b>C470036</b>	凿型烙铁头 2 x 1 mm		通用焊接	焊台: HDE 工具: T470, T470S, T470F, T470M, T470Z, T470N
<b>C470014</b>	凿型烙铁头 4 x 1.3 mm S1		通用焊接	焊台: HDE 工具: T470, T470S, T470F, T470M, T470Z, T470N
<b>C470040</b>	凿型烙铁头 4 x 1.3 mm S2		通用焊接	焊台: HDE 工具: T470, T470S, T470F, T470M, T470Z, T470N
<b>C470035</b>	凿型烙铁头 4 x 2.5 mm		通用焊接	焊台: HDE 工具: T470, T470S, T470F, T470M, T470Z, T470N

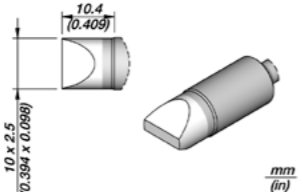
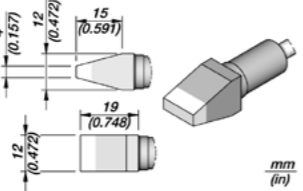
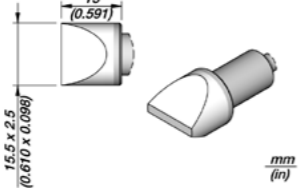
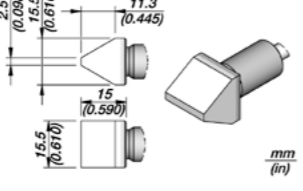
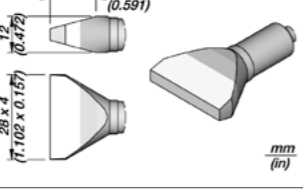

**C470系列烙铁头— T470重负荷手柄和HT470重负荷导热镊夹**

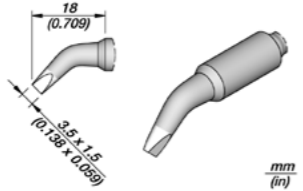
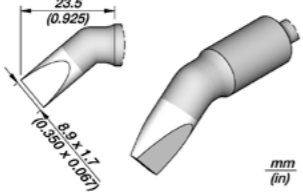
产品料号	产品规格	产品图片	推荐用途	搭配产品
<b>C470017</b>	凿型烙铁头 5 x 1.2 mm		通用焊接	焊台: HDE 工具: T470, T470S, T470F, T470M, T470Z, T470N
<b>C470009</b>	凿型烙铁头 5.5 x 1.5 mm		通用焊接 钣金焊接	焊台: HDE 工具: T470, T470S, T470F, T470M, T470Z, T470N
<b>C470002</b>	凿型烙铁头 6 x 1.5 mm		通用焊接 钣金焊接	焊台: HDE 工具: T470, T470S, T470F, T470M, T470Z, T470N
<b>C470015</b>	凿型烙铁头 6 x 1.7 mm		通用焊接	焊台: HDE 工具: T470, T470S, T470F, T470M, T470Z, T470N
<b>C470004</b>	凿型烙铁头 7.5 x 1.5 mm		通用焊接 钣金焊接	焊台: HDE 工具: T470, T470S, T470F, T470M, T470Z, T470N
<b>C470016</b>	凿型烙铁头 7.5 x 1.7 mm		通用焊接	焊台: HDE 工具: T470, T470S, T470F, T470M, T470Z, T470N
<b>C470058</b>	凿型烙铁头 8 x 2.5 mm		通用焊接 钣金焊接	焊台: HDE 工具: T470, T470S, T470F, T470M, T470Z, T470N
<b>C470039</b>	凿型烙铁头 8.5 x 2.5 mm		通用焊接 钣金焊接	焊台: HDE 工具: T470, T470S, T470F, T470M, T470Z, T470N

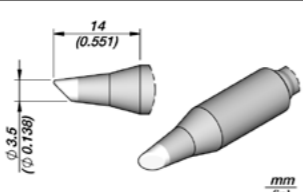

C470系列烙铁头— T470重负手柄和HT470重负荷导热镊夹

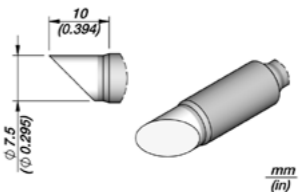
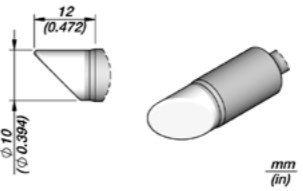
产品料号	产品规格	产品图片	推荐用途	搭配产品
 <b>C470006</b>	凿型烙铁头 10 x 2.5 mm		通用焊接 钣金焊接	焊台: HDE 工具: T470, T470S, T470F, T470M, T470Z, T470N
<b>C470021</b>	凿型烙铁头 12 x 4 mm		通用焊接 钣金焊接	焊台: HDE 工具: T470, T470S, T470F, T470M, T470Z, T470N
<b>C470007</b>	凿型烙铁头 15.5 x 2.5 mm		通用焊接 钣金焊接	焊台: HDE 工具: T470, T470S, T470F, T470M, T470Z, T470N
<b>C470067</b>	凿型烙铁头 15.5 x 2.5 mm		通用焊接 钣金焊接	焊台: HDE 工具: T470, T470S, T470F, T470M, T470Z, T470N, HT470
<b>C470022</b>	凿型烙铁头 28 x 4 mm		钣金焊接	焊台: HDE 工具: T470, T470S, T470F, T470M, T470Z, T470N
 <b>C470034</b>	凿弯型烙铁头 3.5 x 1.5 mm		通用焊接	焊台: HDE 工具: T470, T470S, T470F, T470M, T470Z, T470N
<b>C470018</b>	凿弯型烙铁头 8.9 x 1.7 mm		通用焊接 钣金焊接	焊台: HDE 工具: T470, T470S, T470F, T470M, T470Z, T470N
 <b>C470019</b>	斜面烙铁头 Ø 3.5 mm		通用焊接	焊台: HDE 工具: T470, T470S, T470F, T470M, T470Z, T470N

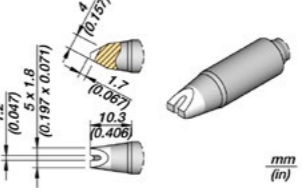
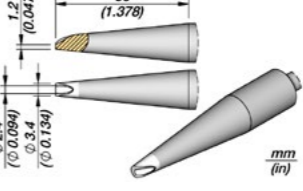
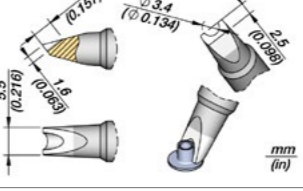
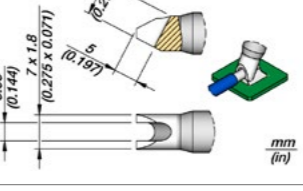
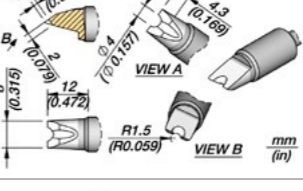
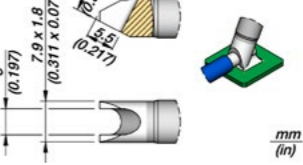
C470系列烙铁头— T470重负手柄和HT470重负荷导热镊夹

产品料号	产品规格	产品图片	推荐用途	搭配产品
 <b>C470003</b>	斜面烙铁头 Ø 7.5 mm		通用焊接 钣金焊接	焊台: HDE 工具: T470, T470S, T470F, T470M, T470Z, T470N
<b>C470056</b>	斜面烙铁头 Ø 10 mm		大面积屏蔽罩拆焊 钣金焊接	焊台: HDE 工具: T470, T470S, T470F, T470M, T470Z, T470N
 <b>C470028</b>	U型烙铁头 Ø 1.2 mm		电线 穿孔焊接	焊台: HDE 工具: T470, T470S, T470F, T470M, T470Z, T470N
<b>C470020</b>	U型烙铁头 Ø 2.4 mm		穿孔焊接	焊台: HDE 工具: T470, T470S, T470F, T470M, T470Z, T470N
<b>C470048</b>	U型烙铁头 Ø 3.4 mm		电线 穿孔焊接	焊台: HDE 工具: T470, T470S, T470F, T470M, T470Z, T470N
<b>C470033</b>	U型烙铁头 Ø 3.65 mm		电线 穿孔焊接	焊台: HDE 工具: T470, T470S, T470F, T470M, T470Z, T470N
<b>C470055</b>	U型烙铁头 Ø 4 mm		电线 穿孔焊接	焊台: HDE 工具: T470, T470S, T470F, T470M, T470Z, T470N
<b>C470030</b>	U型烙铁头 Ø 5 mm		电线 穿孔焊接	焊台: HDE 工具: T470, T470S, T470F, T470M, T470Z, T470N

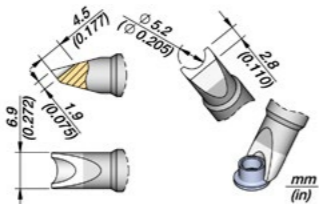
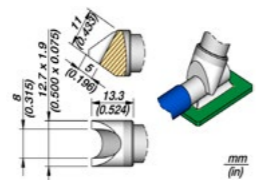
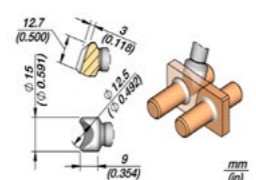
C470系列烙铁头— T470重负手柄和HT470重负荷导热镊夹

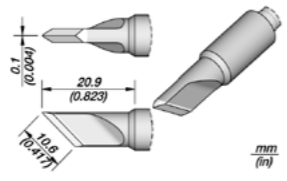
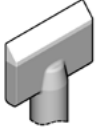
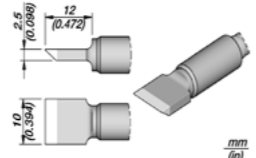
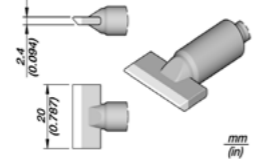
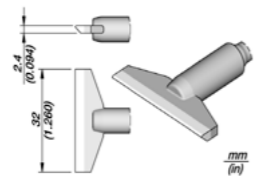
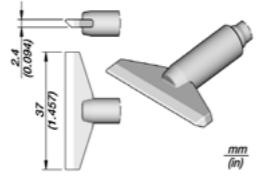
产品料号	产品规格	产品图片	推荐用途	搭配产品
 <b>C470049</b>	U型烙铁头 Ø 5.2 mm		电线 穿孔焊接	焊台: HDE 工具: T470, T470S, T470F, T470M, T470Z, T470N
<b>C470037</b>	U型烙铁头 Ø 8 mm		电线 穿孔焊接	焊台: HDE 工具: T470, T470S, T470F, T470M, T470Z, T470N
<b>C470041</b>	U型烙铁头 Ø 12.5 mm		电线 穿孔焊接	焊台: HDE 工具: T470, T470S, T470F, T470M, T470Z, T470N
 <b>C470061</b>	刀型烙铁头 10.6 mm		拖焊焊接	焊台: HDE 工具: T470, T470S, T470F, T470M, T470Z, T470N
 <b>C470064</b>	铲型烙铁头 10 mm		焊盘清理专用 连接器拆焊	焊台: HDE 工具: T470, T470S, T470F, T470M, T470Z, T470N, HT470
<b>C470059</b>	铲型烙铁头 20 mm		焊盘清理专用 连接器拆焊	焊台: HDE 工具: T470, T470S, T470F, T470M, T470Z, T470N, HT470
<b>C470023</b>	铲型烙铁头 32 mm		焊盘清理专用 连接器拆焊	焊台: HDE 工具: T470, T470S, T470F, T470M, T470Z, T470N, HT470
<b>C470063</b>	铲型烙铁头 37 mm		焊盘清理专用 连接器拆焊	焊台: HDE 工具: T470, T470S, T470F, T470M, T470Z, T470N, HT470

C470系列烙铁头— T470重负手柄和HT470重负荷导热镊夹

产品料号	产品规格	产品图片	推荐用途	搭配产品
 <b>C470046</b>	单面平台烙铁头 7.5 mm		通用焊接 钣金焊接	焊台: HDE 工具: T470, T470S, T470F, T470M, T470Z, T470N, HT470
<b>C470050</b>	铲型烙铁头 Ø 3.8 mm		电线 穿孔焊接	焊台: HDE 工具: T470, T470S, T470F, T470M, T470Z, T470N, HT470
 <b>C470043</b>	拖焊烙铁头 1.1 x 10 mm		电线焊接	焊台: HDE 工具: T470, T470S, T470F, T470M, T470Z, T470N
 <b>C470031</b>	引线/连接器专用烙铁头 Ø 3.3 mm		电线 穿孔焊接	焊台: HDE 工具: T470, T470S, T470F, T470M, T470Z, T470N
<b>C470045</b>	引线/连接器专用烙铁头 Ø 3.5 mm		穿孔公头连接器焊接	焊台: HDE 工具: T470, T470S, T470F, T470M, T470Z, T470N
<b>C470042</b>	引线/连接器专用烙铁头 Ø 4.8 mm		电线 穿孔焊接	焊台: HDE 工具: T470, T470S, T470F, T470M, T470Z, T470N, HT470
<b>C470066</b>	引线/连接器专用烙铁头 Ø 5.5 mm		电线 穿孔焊接	焊台: HDE 工具: T470, T470S, T470F, T470M, T470Z, T470N
<b>C470065</b>	引线/连接器专用烙铁头 Ø 8.5 mm		电线 穿孔焊接	焊台: HDE 工具: T470, T470S, T470F, T470M, T470Z, T470N

C470系列烙铁头— T470重负手柄和HT470重负荷导热镊夹

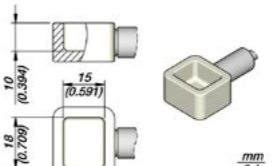
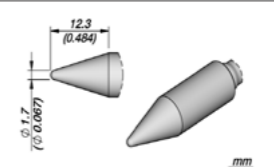

产品料号	产品规格	产品图片	推荐用途	搭配产品
 <b>C470012</b>	引线/连接器专用烙铁头 R. 6 mm S1		电线、连接器适用	焊台: HDE 工具: T470, T470S, T470F, T470M, T470Z, T470N
<b>C470038</b>	引线/连接器专用烙铁头 R. 6 mm S2		大面积电线连接器适用	焊台: HDE 工具: T470, T470S, T470F, T470M, T470Z, T470N
<b>C470047</b>	引线/连接器专用烙铁头 Ø 14 mm		电线 穿孔焊接	焊台: HDE 工具: T470, T470S, T470F, T470M, T470Z, T470N
<b>C470010</b>	引线/连接器专用烙铁头 R. 8 mm		电线、连接器适用	焊台: HDE 工具: T470, T470S, T470F, T470M, T470Z, T470N
<b>C470052</b>	引线/连接器专用烙铁头 R. 8.5 mm		电线、连接器适用	焊台: HDE 工具: T470, T470S, T470F, T470M, T470Z, T470N
<b>C470029</b>	引线/连接器专用烙铁头 R. 31 mm		连接器	焊台: HDE 工具: T470, T470S, T470F, T470M, T470Z, T470N
 <b>C470051</b>	法斯顿端子型烙铁头 21 mm		连接器	焊台: HDE 工具: T470, T470S, T470F, T470M, T470Z, T470N
<b>C470070</b>	法斯顿端子型烙铁头 21 mm		连接器	焊台: HDE 工具: T470, T470S, T470F, T470M, T470Z, T470N
 <b>C470044</b>	平头烙铁头 10 x 15 mm		屏蔽罩拆焊 金属基板 钣金焊接	焊台: HDE 工具: T470, T470S, T470F, T470M, T470Z, T470N

C470系列烙铁头— T470重负手柄和HT470重负荷导热镊夹

产品料号	产品规格	产品图片	推荐用途	搭配产品
 <b>C470057</b>	平头烙铁头 20 x 30 mm		屏蔽罩拆焊 金属基板 钣金焊接	焊台: HDE 工具: T470, T470S, T470F, T470M, T470Z, T470N
<b>C470005</b>	平头烙铁头 Ø 15 mm		屏蔽罩拆焊 金属基板 钣金焊接	焊台: HDE 工具: T470, T470S, T470F, T470M, T470Z, T470N
<b>C470027</b>	平头烙铁头 43 x 20 mm		屏蔽罩拆焊	焊台: HDE 工具: T470, T470S, T470F, T470M, T470Z, T470N
 <b>C470SP01</b>	锡炉烙铁头 15 x 18 mm		线缆上锡锡; 多芯元器件 熔锡穿孔拆焊	焊台: HDE 工具: T470, T470S, T470F, T470M, T470Z, T470N
<b>C470SP42</b>	锡炉烙铁头 40 x 40 mm		线缆上锡锡; 多芯元器件 熔锡穿孔拆焊	焊台: HDE 工具: T470, T470S, T470F, T470M, T470Z, T470N
 <b>C470025</b>	铆接烙铁头 Ø 1.7 mm		热焊塑胶专用	焊台: HDE 工具: T470, T470S, T470F, T470M, T470Z, T470N
<b>C470026</b>	铆接烙铁头 Ø 3.5 mm		热焊塑胶专用	焊台: HDE 工具: T470, T470S, T470F, T470M, T470Z, T470N
<b>C470032</b>	铆接烙铁头 Ø 9 mm		热焊塑胶专用	焊台: HDE 工具: T470, T470S, T470F, T470M, T470Z, T470N
 <b>C470011</b>	钩型烙铁头 Ø 4.2 mm		难以触及的被焊物	焊台: HDE 工具: T470, T470S, T470F, T470M, T470Z, T470N

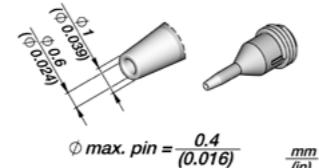
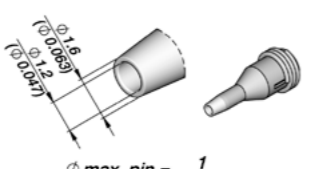

**C360系列小型吸锡嘴—DS360微型吸锡手柄**

产品料号	产品规格	产品图片	推荐用途	搭配产品
 <b>C360001</b>	小型吸锡嘴 Ø 0.6 mm		穿孔拆焊	焊台: CS, DI, DDE, DME 工具: DS360 模块: MSE, MS
<b>C360002</b>	小型吸锡嘴 Ø 0.8 mm		穿孔拆焊	焊台: CS, DI, DDE, DME 工具: DS360 模块: MSE, MS
<b>C360003</b>	小型吸锡嘴 Ø 1 mm		穿孔拆焊	焊台: CS, DI, DDE, DME 工具: DS360 模块: MSE, MS
<b>C360004</b>	小型吸锡嘴 Ø 1.2 mm		穿孔拆焊	焊台: CS, DI, DDE, DME 工具: DS360 模块: MSE, MS
<b>C360007</b>	小型吸锡嘴 Ø 1.4 mm		穿孔拆焊	焊台: CS, DI, DDE, DME 工具: DS360 模块: MSE, MS
<b>C360006</b>	小型吸锡嘴 Ø 1.5 mm		穿孔拆焊	焊台: CS, DI, DDE, DME 工具: DS360 模块: MSE, MS
 <b>C360011</b>	小型吸锡嘴 Ø 0.6 mm Pad		焊盘拆焊	焊台: CS, DI, DDE, DME 工具: DS360 模块: MSE, MS

**C360 系列小型吸锡嘴—DS360小型吸锡手柄**

产品料号	产品规格	产品图片	推荐用途	搭配产品
 <b>C360012</b>	小型吸锡嘴 Ø 0.8 mm Pad		焊盘拆焊	焊台: CS, DI, DDE, DME 工具: DS360 模块: MSE, MS
<b>C360013</b>	小型吸锡嘴 Ø 1 mm Pad		焊盘拆焊	焊台: CS, DI, DDE, DME 工具: DS360 模块: MSE, MS
<b>C360014</b>	小型吸锡嘴 Ø 1.2 mm Pad		焊盘拆焊	焊台: CS, DI, DDE, DME 工具: DS360 模块: MSE, MS



**C560系列吸锡嘴— DR560吸锡手柄**

产品料号	产品规格	产品图片	推荐用途	搭配产品
<b>C560001</b>	吸锡嘴 Ø 0.6 mm HT		穿孔拆焊	焊台: DI, DDE, DME 工具: DR560 模块: MSE, MS
<b>C560014</b>	吸锡嘴 Ø 0.8 mm		穿孔拆焊	焊台: DI, DDE, DME 工具: DR560 模块: MSE, MS
<b>C560002</b>	吸锡嘴 Ø 0.8 mm HT		穿孔拆焊	焊台: DI, DDE, DME 工具: DR560 模块: MSE, MS
<b>C560003</b>	吸锡嘴 Ø 1 mm		穿孔拆焊	焊台: DI, DDE, DME 工具: DR560 模块: MSE, MS
<b>C560017</b>	吸锡嘴 Ø 1.1 mm		穿孔拆焊	焊台: DI, DDE, DME 工具: DR560 模块: MSE, MS
<b>C560004</b>	吸锡嘴 Ø 1.3 x Ø 3.2 mm		穿孔拆焊	焊台: DI, DDE, DME 工具: DR560 模块: MSE, MS
<b>C560009</b>	吸锡嘴 Ø 1.3 x Ø 5 mm		穿孔拆焊	焊台: DI, DDE, DME 工具: DR560 模块: MSE, MS

**C560系列吸锡嘴— DR560吸锡手柄**

产品料号	产品规格	产品图片	推荐用途	搭配产品
<b>C560005</b>	吸锡嘴 Ø 1.5 mm		穿孔拆焊	焊台: DI, DDE, DME 工具: DR560 模块: MSE, MS
<b>C560006</b>	吸锡嘴 Ø 1.9 mm		穿孔拆焊	焊台: DI, DDE, DME 工具: DR560 模块: MSE, MS
<b>C560018</b>	吸锡嘴 Ø 2.2 mm		穿孔拆焊	焊台: DI, DDE, DME 工具: DR560 模块: MSE, MS
<b>C560007</b>	吸锡嘴 Ø 2.4 mm		穿孔拆焊	焊台: DI, DDE, DME 工具: DR560 模块: MSE, MS
<b>C560015</b>	吸锡嘴 Ø 3 mm		穿孔拆焊	焊台: DI, DDE, DME 工具: DR560 模块: MSE, MS
<b>C560011</b>	吸锡嘴 Ø 0.6 mm HT Pad		焊盘拆焊	焊台: DI, DDE, DME 工具: DR560 模块: MSE, MS
<b>C560012</b>	吸锡嘴 Ø 0.8 mm HT Pad		焊盘拆焊	焊台: DI, DDE, DME 工具: DR560 模块: MSE, MS
<b>C560013</b>	吸锡嘴 Ø 1 mm Pad		焊盘拆焊	焊台: DI, DDE, DME 工具: DR560 模块: MSE, MS





**W140系列铲型烙铁头— WS140精密剥线镊夹**

产品料号	产品规格	产品图片	推荐用途	搭配产品
<b>W14003F</b>	平面铲型烙铁头 3 mm		电线绝缘层剥离	焊台: WSS 工具: WS140
<b>W14005F</b>	平面铲型烙铁头 5 mm		电线绝缘层剥离	焊台: WSS 工具: WS140
<b>W14012F</b>	平面铲型烙铁头 12 mm		电线绝缘层剥离	焊台: WSS 工具: WS140
<b>W14014G</b>	单孔剥线烙铁头 实心线 14 AWG		电线绝缘层剥离	焊台: WSS 工具: WS140
<b>W14016G</b>	单孔剥线烙铁头 实心线 16 AWG		电线绝缘层剥离	焊台: WSS 工具: WS140
<b>W14018G</b>	单孔剥线烙铁头 实心线 18 AWG		电线绝缘层剥离	焊台: WSS 工具: WS140
<b>W14020G</b>	单孔剥线烙铁头 实心线 20 AWG		电线绝缘层剥离	焊台: WSS 工具: WS140
<b>W14022G</b>	单孔剥线烙铁头 实心线 22 AWG		电线绝缘层剥离	焊台: WSS 工具: WS140

**W140 系列铲型烙铁头— WS140精密剥线镊夹**

产品料号	产品规格	产品图片	推荐用途	搭配产品
<b>W14024G</b>	单孔剥线烙铁头 实心线 24 AWG		电线绝缘层剥离	焊台: WSS 工具: WS140
<b>W14026G</b>	单孔剥线烙铁头 实心线 26 AWG		电线绝缘层剥离	焊台: WSS 工具: WS140
<b>W14028G</b>	单孔剥线烙铁头 实心线 28 AWG		电线绝缘层剥离	焊台: WSS 工具: WS140
<b>W14030G</b>	单孔剥线烙铁头 实心线 30 AWG		电线绝缘层剥离	焊台: WSS 工具: WS140
<b>W14032G</b>	单孔剥线烙铁头 实心线 32 AWG		电线绝缘层剥离	焊台: WSS 工具: WS140
<b>W14034G</b>	单孔剥线烙铁头 实心线 34 AWG		电线绝缘层剥离	焊台: WSS 工具: WS140
<b>W14036G</b>	单孔剥线烙铁头 实心线 36 AWG		电线绝缘层剥离	焊台: WSS 工具: WS140
<b>W14037G</b>	单孔剥线烙铁头 实心线 37 AWG		电线绝缘层剥离	焊台: WSS 工具: WS140
<b>W14038G</b>	单孔剥线烙铁头 实心线 38 AWG		电线绝缘层剥离	焊台: WSS 工具: WS140
<b>W14040G</b>	单孔剥线烙铁头 实心线 40 AWG		电线绝缘层剥离	焊台: WSS 工具: WS140



