

JBC

www.jbctools.com

English



Precision Hot Air Station without extractor desk

Ref. TE-QC

Packing List

The following items should be included:

JTE Control Unit1 unit
Ref. JTE-1C (120V)
JTE-2C (230V)
JTE-9C (100V)



Precision Heater hose set1 unit
Ref. TE-TB



Stand1 unit
Ref. TE-SA



Nozzles3 units
Ref. TN9209 Ø 3mm (x1)
TN9208 Ø 4mm (x1)
TN9080 Ø 5mm (x1)



Power Cord1 unit
Ref. 0009417 (100V/120V)
0009401 (230V)



Manual1 unit
Ref. 0015899



Features

USB-B connector
Update the station software from the JBC website

Activates the suction pump



Precision Heater Hose set
Ref. TE-TB

Suction Tube
Ref. 0932330
For tripods and extractors

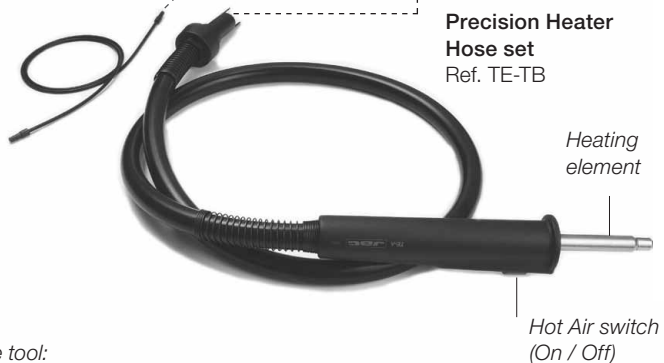

Other connectable tool:
Heater hose set
Ref: JT-TA

To Pedal
Ref. P-005
Press the pedal to start hot air or release to stop.

Power Socket
Fuse



Adjustable Stand Nozzle Changer

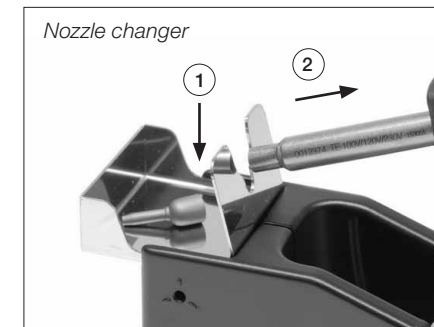
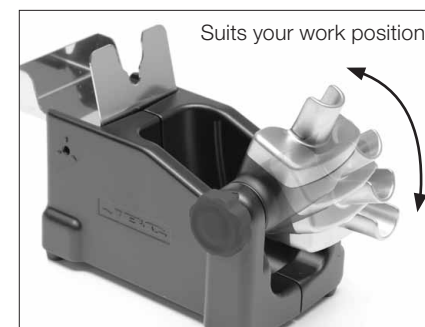

Compatible Nozzles

The TE-TB works with TE nozzles. Find the model that best suits your soldering needs in www.jbctools.com

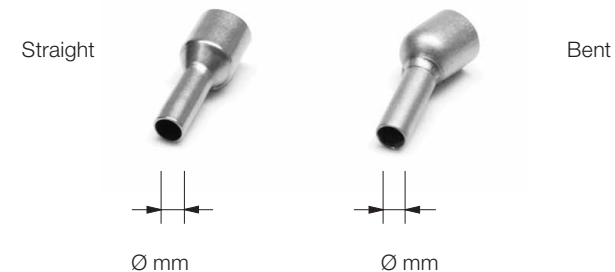

Ref.	Shape	Size
TN9209	Straight	Ø 3mm
TN9208	Straight	Ø 4mm
TN9080	Straight	Ø 5mm
TN9787	Bent	Ø 3mm
TN9785	Bent	Ø 4mm
TN9782	Bent	Ø 5mm

Operation

1. Placing

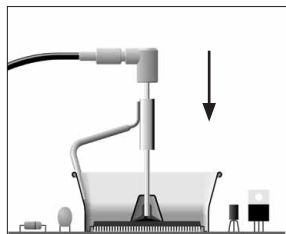

Position the extractor with the appropriate suction cup and press the suction button.

2. Heating

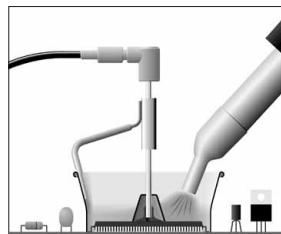

Heat the component by pressing the heater button.

3. Releasing

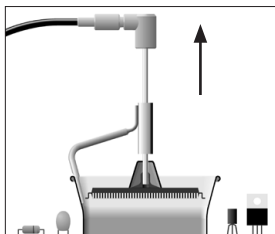

The component lifts off automatically when the solder melts.

Process Control

Manual Mode

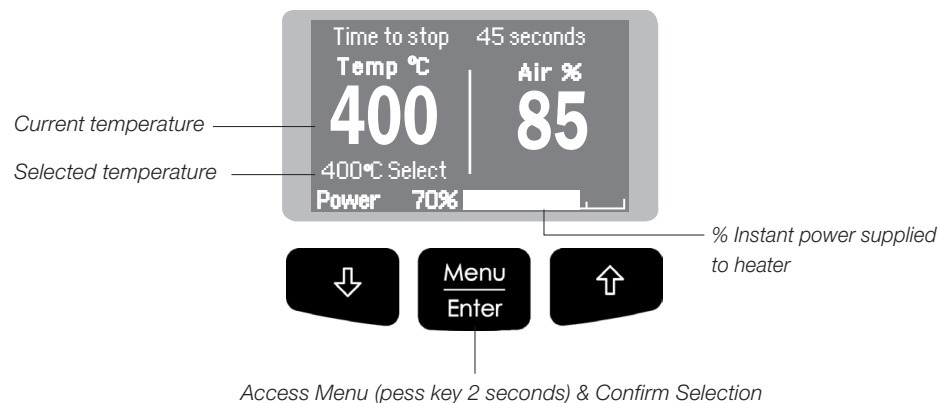

You can switch between operating modes (Manual Mode / Program Mode) by pressing the "increase" and "decrease" keys simultaneously for 2 seconds. (Only when Program mode is ON)

Program Mode

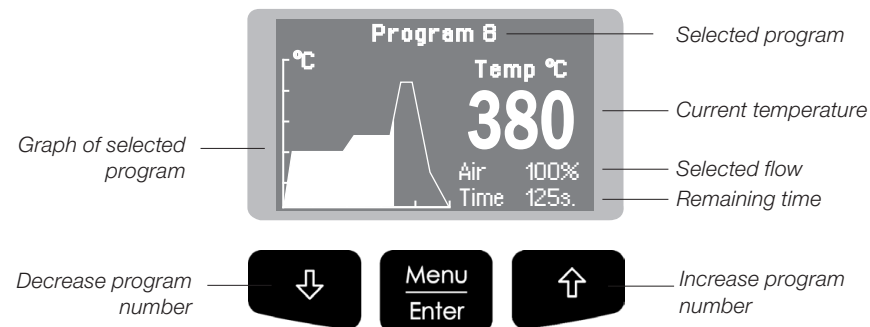

Edit Program

This option allows you to edit or create a program.

First, you must select the program to edit and then modify the points that make up the program.

Each program is composed of 9 points, each point consisting of 3 parameters:

1. Time (seconds)
2. Temperature (°C / °F)
3. Flow rate (%)

You can delete the last point of the program by selecting "----" in the time parameter.

It should be taken into account that the regulation range permitted by the station is between 150°C and 450°C, so it is not possible to create temperature ramps between room temperature (Toff) and 150°C.

The station can store up to 25 temperature programs.

The first three programs are edited as an example.

Copy Program

This option allows you to copy a program.

You must select the program source and the program destination (where it will be copied).

Delete Program

This option will allow you to delete a previously selected program.

Menu Screen

Original PIN: 0105

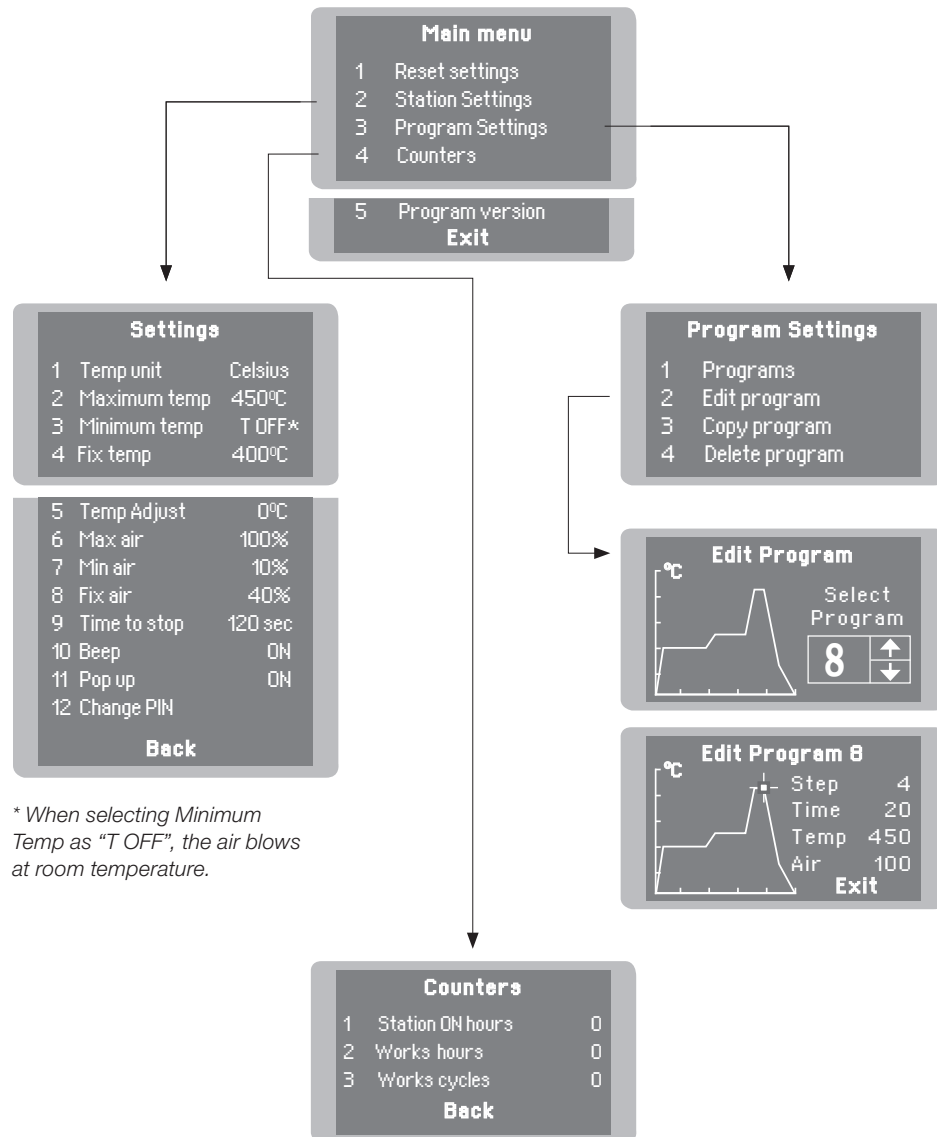

Replacing the Heating Element

Only perform this operation when the element is cold and the unit is disconnected from the mains.

1. Loosen the screw.
2. Pull the heating element away from the handle.
3. Connect the new heating element, ensuring it is pushed all the way in.
4. Tighten the screw.

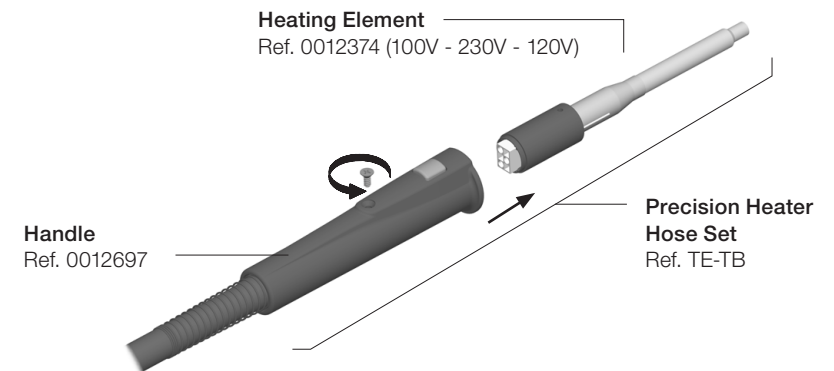

Changing the TE-TB Precision Heater Hose Set

1. Ensure that the tool is turned off.
2. Use a spanner to unscrew the connecting nut.
3. When attaching the new tube make sure the rib lines up with the groove on the control unit.
4. Tighten with the spanner.



Hot Air Accessories (not supplied with TE-Q)

Find the model that best suits your soldering needs in www.jbctools.com

Protector



Tripod



Extractor



Manual extractor



For small components (fig. 1 and 2).

We recommend using the protector + tripod.

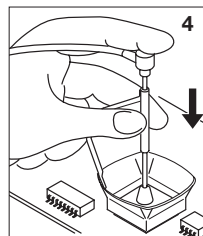
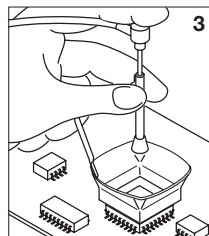
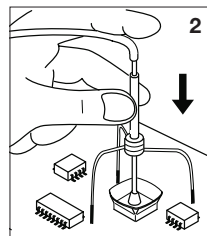
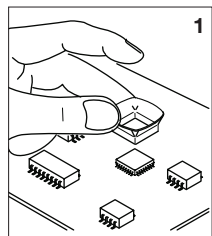

For big components (fig. 3 and 4).

We recommend using the extractor.

Extractor Desk

This accessory lets you quickly switch between different models of extractors and protectors. There are two drawers for storage.

Extractor desk
Ref. 0008752

*Protectors
and extractors
not included.*



Pick & Place

This tool helps you easily place and remove SMDs of any size thanks to the suction system.

Pick & Place
Ref. T260-A



Bent Needles Set
Ref. 0861660



Straight Needles Set
Ref. 0901546



Suction Cups
Ref. 0930110



Operation

Choose the needle and the suction cup that best fits the component and start working as follows:

*Press the button to
start/stop the suction*

Pick & Place
Ref. T260-A

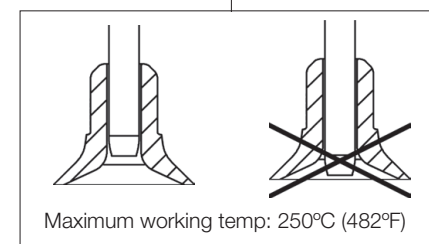
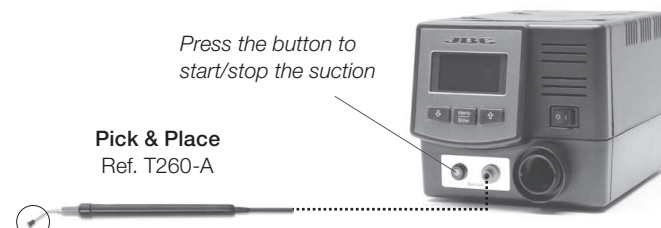

Insert the needle with the appropriate cup for a correct suction process.

You should avoid the needle protruding from the lower part.

1. Suction

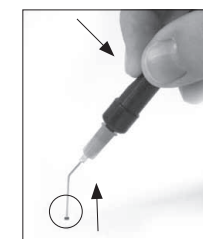

Once the suction is activated, cover the pen hole with your finger and lift off the component.

2. Release

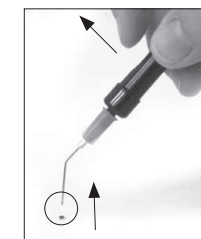

Lift your finger to release the component in the appropriate place.

Maintenance

Before carrying out maintenance or storage, always allow the equipment to cool.

- Clean the station screen with a glass cleaner or a damp cloth.
- Use a damp cloth to clean the casing and the tool. The metal parts can also be cleaned with alcohol.
- Maintain heating element clean prior to storage in order to avoid oxidation. Rusty and dirty surfaces reduce heat transfer.
- Periodically check all cables and tubes.
- Replace a blown fuse as follows:

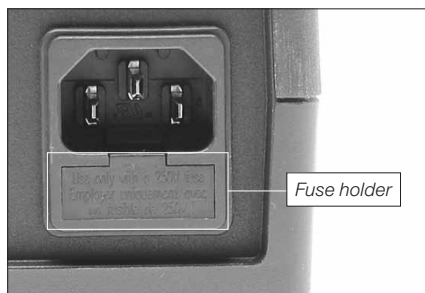

1. Pull off the fuse holder and remove the fuse. If necessary use a tool to lever it off.

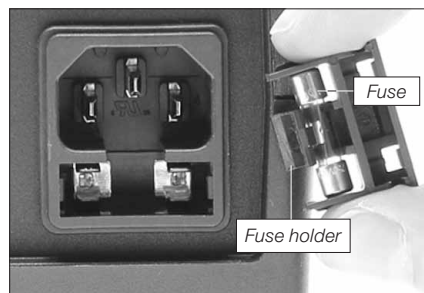

2. Press the new fuse into the fuse holder and replace it in the station.

- Replace any defective or damaged pieces. Use original JBC spare parts only.
- Repairs should only be performed by a JBC authorized technical service.

Safety



It is imperative to follow safety guidelines to prevent electric shock, injury, fire or explosion.

- Do not use the units for any purpose other than soldering or rework. Incorrect use may cause fire.
- The power cord must be plugged into approved bases. Be sure that it is properly grounded before use. When unplugging it, hold the plug, not the wire.
- Do not work on electrically live parts.
- The tool should be placed in the stand when not in use in order to activate the sleep mode. The soldering tip, the metal part of the tool and the stand may still be hot even when the station is turned off. Handle with care, including when adjusting the stand position.
- Do not leave the appliance unattended when it is on.
- Do not cover the ventilation grills. Heat can cause inflammable products to ignite.
- Use a “non residue” classified flux and avoid contact with skin or eyes to prevent irritation.
- Be careful with the fumes produced when soldering.
- Keep your workplace clean and tidy. Wear appropriate protective glasses and gloves when working to avoid personal harm.
- Utmost care must be taken with liquid tin waste which can cause burns.
- This appliance can be used by children over the age of eight and also persons with reduced physical, sensory or mental capabilities or lack of experience provided that they have been given adequate supervision or instruction concerning use of the appliance and understand the hazards involved. Children must not play with the appliance.
- Maintenance must not be carried out by children unless supervised.

Specifications

- TE-1QC** 120V 50/60Hz. Input fuse 8A. Rated Current 6A. Control Unit model: **JTE-1C**
TE-2QC 230V 50/60Hz. Input fuse 4A. Rated Current 3A. Control Unit model: **JTE-2C**
TE-9QC 100V 50/60Hz. Input fuse 8A. Rated Current 7A. Control Unit model: **JTE-9C**
- Weight: 5.2 kg (11.4 lb)
 - Dimensions: 148 x 184 x 140
 - Nominal Power: 300W
 - Temperature selection: Room temperature / 150°C to 450°C (300°F to 840°F)
Cool mode: T Off. Used to blow air at room temperature
 - Ambient Operating Temperature: 10 to 40°C (50-104°F)
 - Idle Temp. Stability: +/-20 °C (+/-36 °F)
 - Air flow regulation: 3-17 SLPM
 - USB connector station-PC
 - P-005 Pedal connector

Complies with CE standards
ESD protected housing "skin effect"

Exploded View

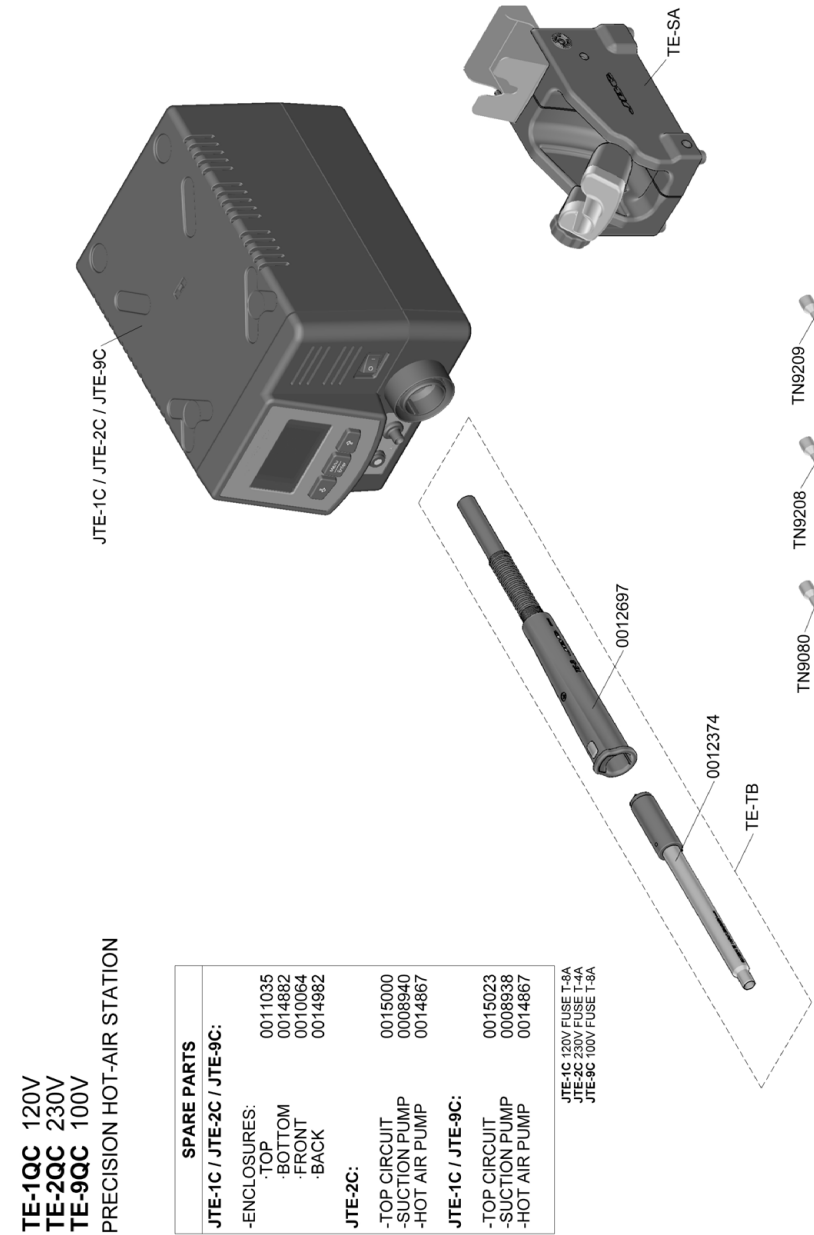

JBC

Warranty

JBC's 2 year warranty covers this equipment against all manufacturing defects, including the replacement of defective parts and labour.

Warranty does not cover product wear due to use or mis-use.

In order for the warranty to be valid, equipment must be returned, postage paid, to the dealer where it was purchased.



This product should not be thrown in the garbage.

In accordance with the European directive 2002/96/EC, electronic equipment at the end of their life must be collected and returned to an authorized recycling facility.