

JBC

www.jbctools.com

INSTRUCTION MANUAL



FAE2

Fume Extractor for 2 Workbenches

This manual corresponds to the following references:

FAE2-5B (100V/120V/230V)

Packing List

The following items are included:



 Unseal the filter and remove its bottom protection before its first use

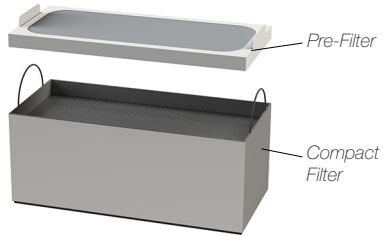

Fume Extractor for 2 Workbenches ...1 unit

Filter for FAE2 1 unit
Ref. FAE2-100 (already assembled)



Power Cable 1 unit
Ref. 0023715 (100V/120V)
0023714 (230V)



Compact Station Cable (USB A/B) 2 units
Ref. 0021042



Compact Station Adapter (RJ12 to USB A) 2 units
Ref. 0023504



Cleaning Stick 1 unit
Ref. 0004009



Premium Station Cable (RJ12) 2 units
Ref. 0019751



Manual 1 unit
Ref. 0028160

Features and Connections

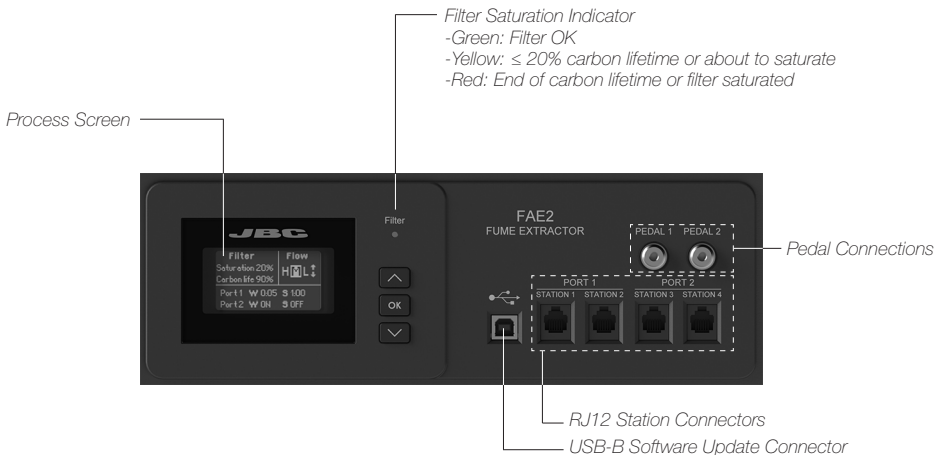

Modular Station Connection

JBC Soldering Stations feature a robot port to the fume extractor in order to automatically activate the extraction when the tools are in use. Use the Premium Station Cable (included) for the connection.

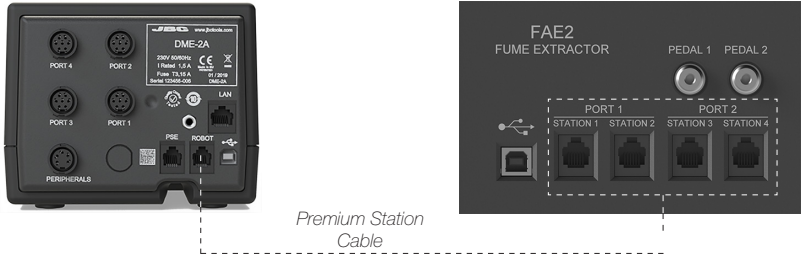

Connect up to 4 stations directly to a fume extractor through the soldering station robot port. Every tool connected to a station can control the aspiration system.

Each Station detects the fume extractor as "FAE_a". The tool that should activate the fume extraction need to be configured through the peripheral menu option on the station menu.

Peripherals Menu

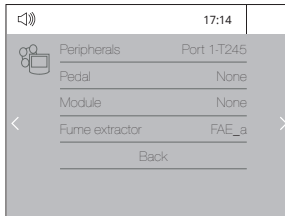

Note: For a correct operation always update soldering stations with the latest available software version. The minimum required version is 8886160 for DDE, HDE and NAE stations and 8886162 for DME stations.

Compact Station Connection - Up to Station Version "E":

Connect the USB-B connector of the JBC soldering station to the fume extractor using the compact station cable and adapter. The suction starts automatically when the tool is lifted from the tool holder.

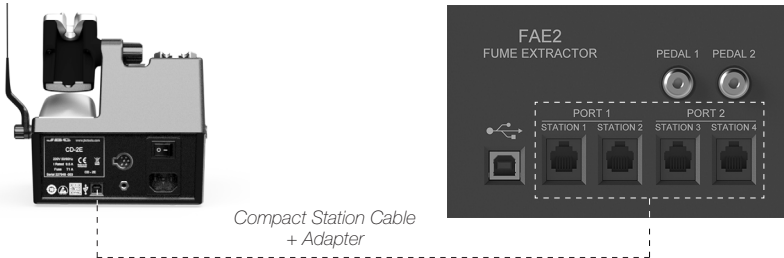

Compact Station Connection - From Station Version "F" on:

Connect the JBC soldering station to the fume extractor using the Premium Station Cable (RJ12). The suction starts automatically when the tool is lifted from the tool holder.

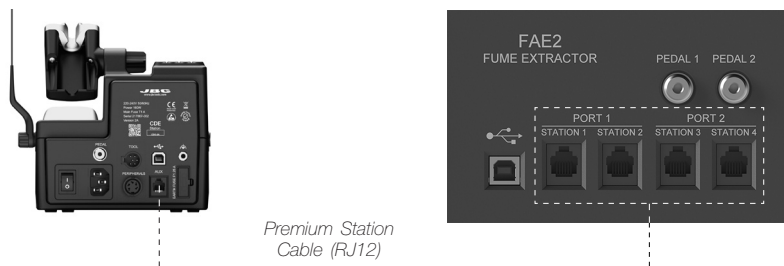

Assembly Options

2 Workbenches Configuration (default)

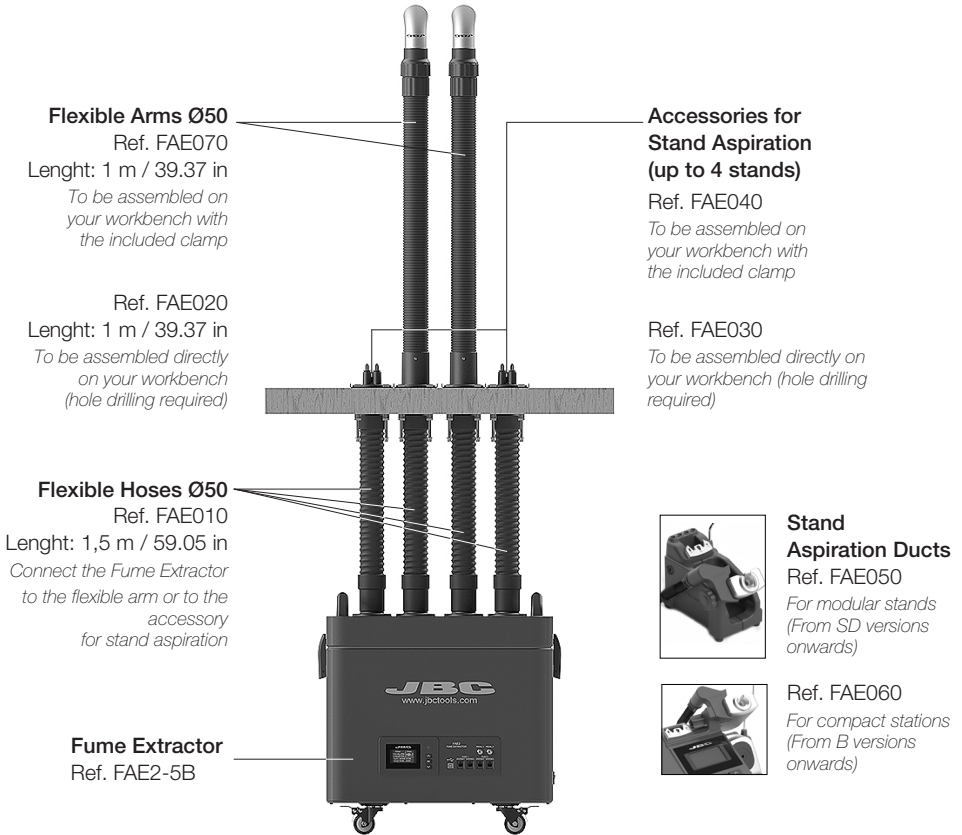

Main Screen

Access by and to change the aspiration program.

Preset program screen

Filter	Flow
Saturation 20%	H M L
Carbon life 90%	
Port 1 W 0:05 S 1:00	
Port 2 W ON S OFF	

High, medium and low preset aspiration programs

Stand aspiration flow status

Flexible arm aspiration flow status (work aspiration)

Custom program screen

Filter	Flow
Saturation 20%	100%
Carbon life 90%	
Port 1 W 0:05 S 1:00	
Port 2 W ON S OFF	

Flow rate

4 Workbenches Configuration *(optional)*

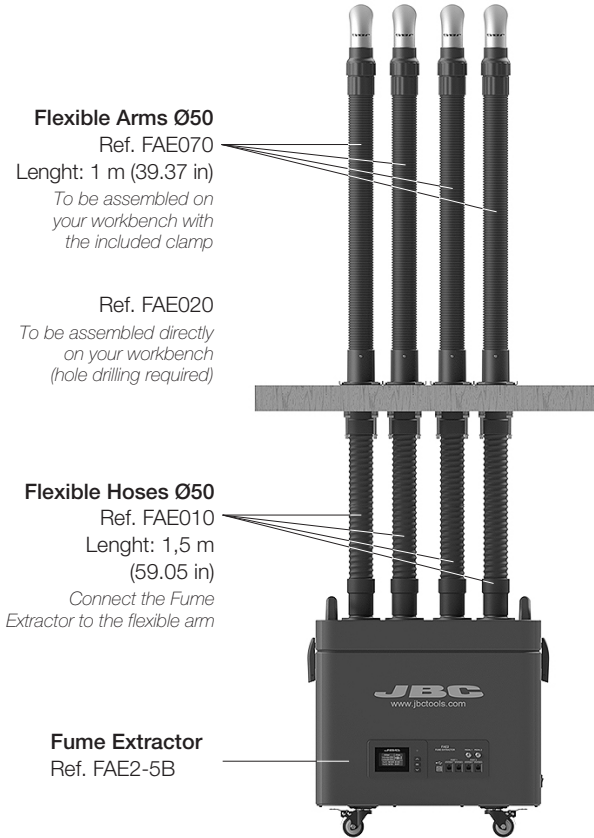

Flexible Arms Ø50

Ref. FAE070

Length: 1 m (39.37 in)

To be assembled on your workbench with the included clamp

Ref. FAE020

To be assembled directly on your workbench (hole drilling required)

Flexible Hoses Ø50

Ref. FAE010

Length: 1,5 m (59.05 in)

Connect the Fume Extractor to the flexible arm

Fume Extractor

Ref. FAE2-5B

In order to set this configuration, change workbench parameter to 4 (see page 7).

In this configuration stand aspiration is not available.

Aspiration flow is set to high level.

Note: Suction force per intake decreases compared to “2 workbenches configuration” (see page 14).

Main Screen

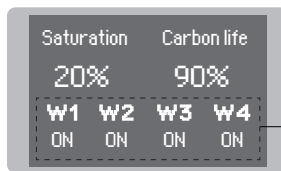

Aspiration intake status (work intake)

Workbench Configuration:

For 2 Workbenches:

Stations (Excellence or Advanced range) connected to RJ12 connectors station1 and station2 can control flexible arm1/stand1 aspiration intakes, whereas those which are connected to station3 and station4 can control flexible arm2/stand2 aspiration intakes.

For 4 Workbenches:

Each station connected to RJ12 connector stationX can control flexible armX aspiration intake (e.g. station2 controls aspiration arm2).

Continuous Mode

When continuous mode is enabled the 4 aspiration intakes are opened and fume extractor suction is activated. Aspiration remains active until continuous mode is disabled or the equipment is powered off. (See details on page 9).

Equipment Software Update

JBC Updater

The fume extractor can be updated via the USB-B connection by means of JBC Updater software. Download software from: www.jbctools.com/software.html.

Note: For the updating process the Premium Station Cable (RJ12) has to be disconnected. If a station is connected to RJ12 connector the update process will not start.



Menu Interface

Main Menu Parameters

Original Pin: 0105

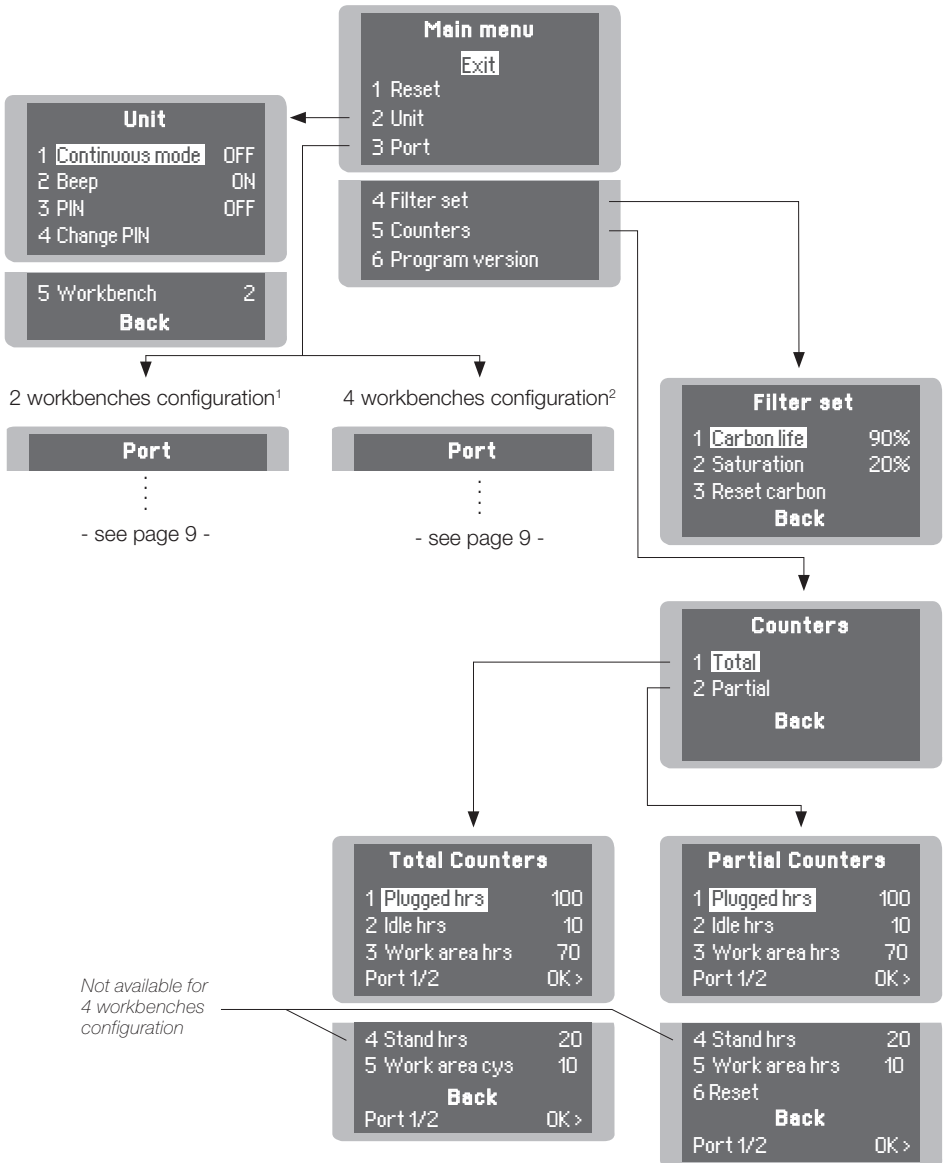

Menu Interface

¹ Port Menu for 2 Workbenches Configuration

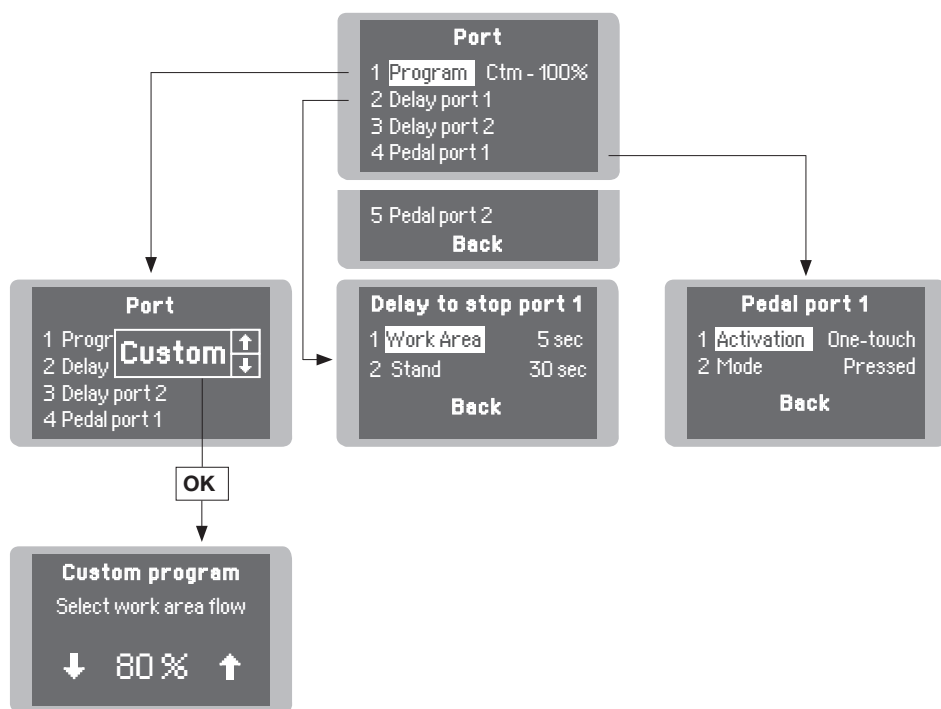

² Port Menu for 4 Workbenches Configuration

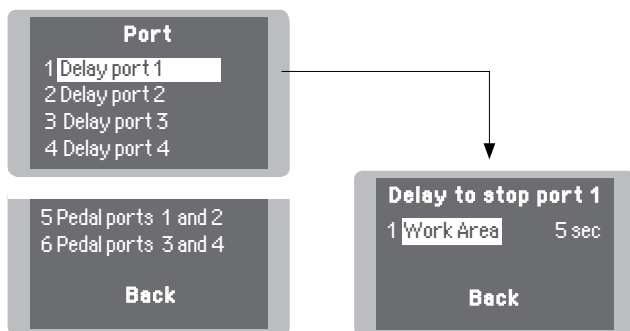

Fume Extractor Activation

Once the fume extractor is switched on, the display shows a similar screen as the following one and the filter saturation indicator is green if the carbon lifetime is higher than 20%.

Filter		Flow	
Saturation	0%	H M L ↓	↑
Carbon life	100%		
Port 1	W OFF	S OFF	
Port 2	W OFF	S OFF	

- Green: Filter OK
- Yellow: ≤ 20% carbon lifetime or about to saturate
- Red: End of carbon lifetime or filter saturated

If the display shows STOP#4 or STOP#7, power off the fume extractor, remove the cover, place it back and secure it using the quick release levers.

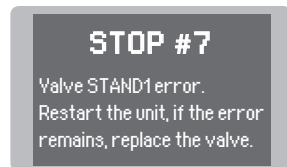
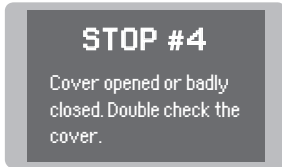

If the STOP#7 remains, replace the valve (ref. 0018831).

Parameters



Important: Power off any station or device connected to the fume extractor before modifying any parameter.

Unit

Parameter	Description
Continuous mode	Enable/disable continuous aspiration. When enabled the 4 aspiration intakes are opened and fume extractor suction is activated. Aspiration remains active until continuous mode is disabled or the equipment is powered off. By default Continuous mode is OFF.
Beep	Enable/disable the sound of the keypad. By default Beep is ON.
PIN	Enable/disable PIN request when modifying parameters. By default PIN is ON.
Change PIN	Change the default security PIN code. By default the PIN is 0105.
Workbench	Select working mode for 2 or 4 workbenches. By default workbench is 2.

Port

Parameter	Description
Program	<p>It sets the fume extractor aspiration flow. You can select between preset and custom aspiration programs.</p> <p>H (High), M (Medium) or L (Low) are the three preset options available. Use up and down keys to switch between them while being on the main screen. Up to ten aspiration levels between H (High) and L (Low) can be selected for custom program (range 10-100%). If a custom aspiration program is selected, the selected aspiration level can be changed on main the screen. By default M (Medium) aspiration program is selected.</p>
Delay to stop / Stand	<p>It sets the time that a fume extractor keeps aspirating fumes at the stand once the tool is returned to it (range 0-999 seconds). By default stand time is 60 seconds.</p>
Delay to stop / Work area	<p>It sets the time that a fume extractor keeps aspirating fumes at the work area once the tool is returned to the stand (range 0-300 seconds).</p>
Pedal / Activation	<p>It sets the pedal activation mode.</p> <p>One-touch: Press the pedal once to activate aspiration. Press again to stop aspiration.</p> <p>Pressed: (for activation mode must be selected "pressed") aspiration is active as long as the pedal is kept pressed.</p> <p>By default activation mode is "pressed".</p>
Pedal / Mode	<p>When the activation parameter is set to pressed, the mode parameter can be configured to released mode. In this mode aspiration is always active until the pedal is pressed.</p> <p>By default mode is pressed.</p>

Filter Set

Parameter	Description
Carbon life	It shows remaining activated carbon lifetime expressed in %. It is also displayed on the main screen. When 0% is reached the system will show pop-up message STOP#1 to replace the filter.
Saturation	It shows saturation status of HEPA + carbon filter set, expressed in %. It is also displayed on the main screen. When 100% is reached the system will show pop-up message STOP#2 to replace the filter.
Reset carbon	Perform this action after replacing the HEPA + carbon filter set. The carbon lifetime counter will not start until the filter is detected for the first time. After executing that function Carbon life will be 100%.

Extraction Control

Fume extractor aspiration may be controlled by:

Pedal Connection

By means of the pedal connection, fume extractor aspiration may be activated/deactivated by a P-005/P-405 pedal. (See pedal activation modes on page 10)

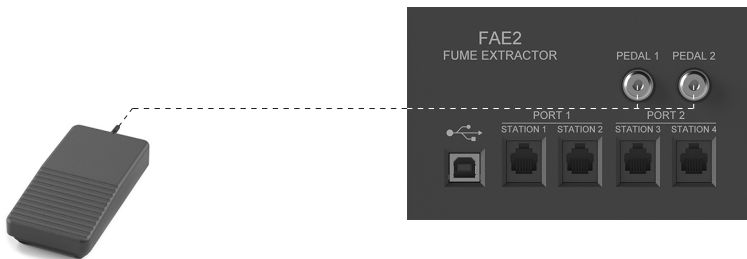

Fume Extractor Configurations

Some parameters, features and the performance vary depending on fume extractor working mode, see the following table:

	Mode: 2 Workbenches	Mode: 4 Workbenches
Flexible Arm Aspiration Intakes	2	4
Stand Aspiration Intakes	2	Not available
Flow per Flexible Arm Intake	76 m ³ / h (44.73 cfm)	52 m ³ / h (30.6 cfm)
Flow per Stand Intake	4 m ³ / h (2.35 cfm)	Not available
Preset Aspiration Programs	3	1
Custom Aspiration Programs	9	Not a available
Power Consumption	400 W	500 W

Maintenance - Filter Replacement

- The unit notifies through both the display and the LED when filters need maintenance.
- To replace the filters, first turn the fume extractor off. Then remove the cover by opening the quick release lever of the casing (1).
- Once the pre-filter has been changed and the saturation indicator is on, means that the compact filter is already saturated and must be replaced too.
- The duration of the compact filter is 1 year maximum once its packaging is opened.
- Once the compact filter has been replaced, the filter counter must be reset. (Main Menu > Filter Set > Reset Carbon)
- If the display shows an error when the equipment is switched on, the cover and casing connectors are probably dirty (2) and making false contact. Remove the cover and clean both connectors.
- If the filter is changed while the fume extractor is on, once the cover is placed the equipment starts an automatic filter detection process: the work valves open, the stand valves close and the fume extractor suctions for a few seconds.

Pre-Filter for FAE2

Ref. FAE2-110

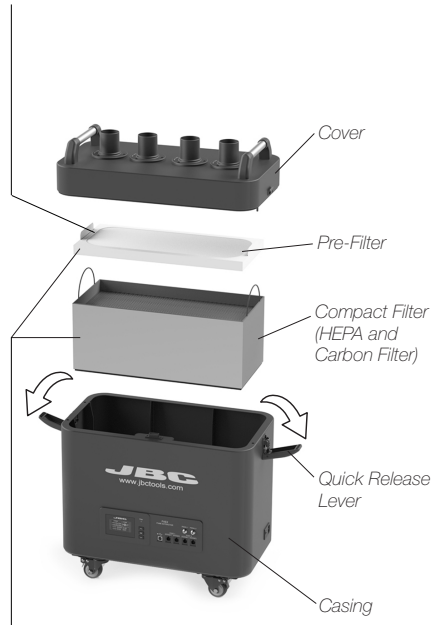

Filter for FAE2

Ref. FAE2-100

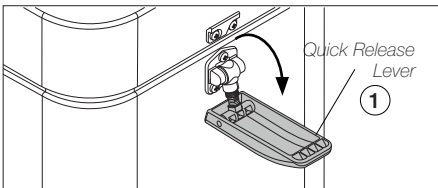
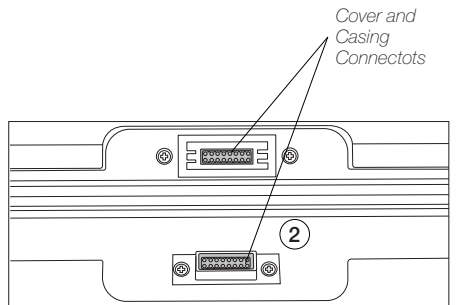

 **Read the safety guidelines to do the equipment maintenance safely.**

Maintenance - Valves

- Check the status of the valves when replacing the pre-filter or the compact filter.
- Use the cleaning stick if necessary and clean with alcohol to remove dirt residues.

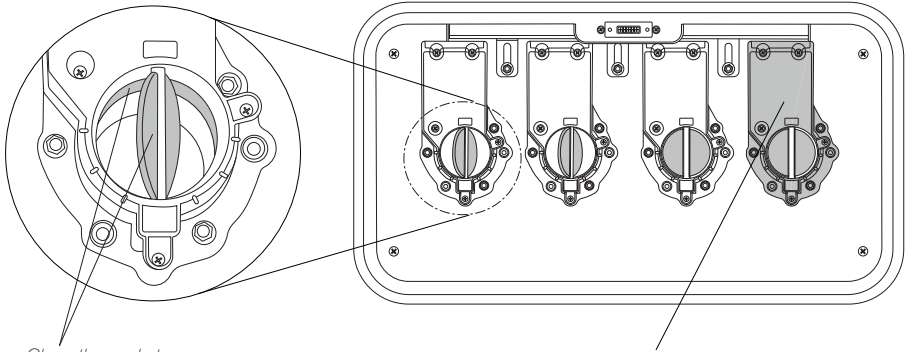

*Clean the gasket
and the disc on
both sides*

Intake Valve
Ref. 0018831

Quick Release Lever Adjustment

- The locking force between casing and cover can be adjusted by turning the knurled nut of the locking mechanism.
- Turn clockwise to loosen and counterclockwise to tighten.

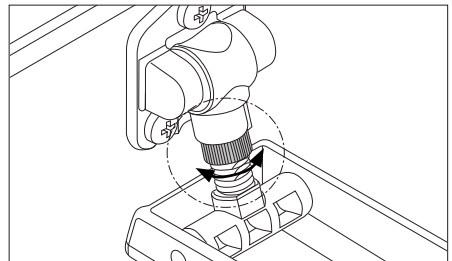

Read safety guidelines to do the equipment maintenance safety.

Safety



Follow safety guidelines to prevent electric shock, injury, fire or explosion.

- The equipment is designed to filtrate only the fumes generated by soldering.
- Do not use the units for the filtration of combustible, explosive or corrosive gasses. Incorrect use may cause fire.
- The power cord must be plugged into approved bases. Be sure that it is properly grounded before use. When unplugging it, hold the plug, not the wire.
- Do not leave the appliance unattended when it is on.
- Do not cover the ventilation grills. Heat can cause inflammable products to ignite.
- This appliance can be used by children over the age of eight and persons with reduced capabilities or lack of experience provided that they have been given adequate supervision or instruction concerning use of the appliance and understand the hazards involved.
- Maintenance must not be carried out by children unless supervised.
- Keep your workplace clean and tidy. Wear appropriate protective mask, glasses and gloves when handling dirt filter or pre-filter.
- The quick release levers of the casing are only for handling the cover, not the complete equipment.
- Do not use the equipment without the filters.
- Saturated filters can not be cleaned and reused.
- Avoid blowing the filter or the dirty parts of the equipment, if necessary it is advisable to vacuum.
- Avoid losing particles in the filter during handling it.
- Treat the saturated filters as waste depending on the filtered contaminant and the applicable standards in each country. This is the European Waste Catalog classification:
 - 15 02: Absorbents, filter materials, wiping cloths and protective clothing.
 - 15 02 02: Absorbents, filter materials (including oil filters not otherwise specified, wiping cloths, protective clothing contaminated by dangerous substances.
 - 15 02 03: Absorbents, filter materials, wiping cloths and protective clothing.
- In case of not complying with the filter change recommendations, the maximum particle and gas concentrations established in each country could be exceeded.

Specifications

F AE2

Fume Extractor for 2 Workbenches

Ref.: **F AE2-5B120V** 50/60Hz. Input power: 500W

Ref.: **F AE2-5B230V** 50/60Hz. Input power: 500W

Ref.: **F AE2-5B100V** 50/60Hz. Input power: 320W

- Max. Flow Rate: 290 m³/h / 10241.25 f³/h
- Max. Vacuum: 6,1 KPa / 0.88 psi
- Blower Type: Brushless
- Working Areas (Workbenches): 2 or 4
- Noise: 54 dB
- Pre-Filter: Medium dust filter M5 (EN 779)
- Compact Filters: H13 particle filter (EN 1822)
Activated carbon filter
- Fuse: 8 AT
- Connections: USB-B (to PC)
RJ12 (to stations)
- Fume Extractor Dimensions / Weight: 560 x 320 x 590 mm / 33,6 kg
(L x W x H) 22.05 x 12.59 x 23.23 in / 74.08 lb
- Total Package Dimensions / Weight: 725 x 485 x 760 mm / 36 kg
(L x W x H) 28.54 x 19.09 x 29.92 in / 79.37 lb

Complies with CE standards.

ESD safe.

JBC

Warranty

JBC's 2 year warranty covers this equipment against all manufacturing defects, including the replacement of defective parts and labour.

Warranty does not cover product wear or misuse.

In order for the warranty to be valid, equipment must be returned, postage paid, to the dealer where it was purchased.

Get 1 extra year JBC warranty by registering here:
<https://www.jbctools.com/productregistration/>
within 30 days of purchase.



This product should not be thrown in the garbage.

In accordance with the European directive 2012/19/EU, electronic equipment at the end of its life must be collected and returned to an authorized recycling facility.



www.jbctools.com

0028160-130323