

JBC

www.jbctools.com

INSTRUCTION MANUAL



CDB

Soldering Station

This manual corresponds to the following references:

- CD-9BQF (100V)
- CD-1BQF (120V)
- CD-2BQF (230V)

Packing List

The following items are included:



Control Unit 1 unit



General Purpose Handle 1 unit
Ref. T245-A



Power Cord 1 unit
Ref. 0024092 (100V)
0023715 (120V)
0023714 (230V)



Brass Wool 1 unit
Ref. CL6210



Sponge 1 unit
Ref. S0354

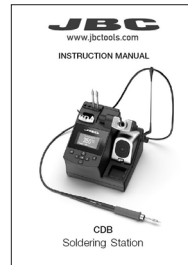

Manual 1 unit
Ref. 0026943

Features and Connections

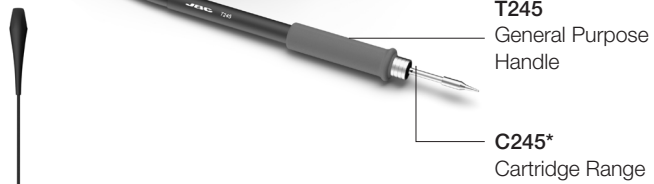

** not included, sold separately*

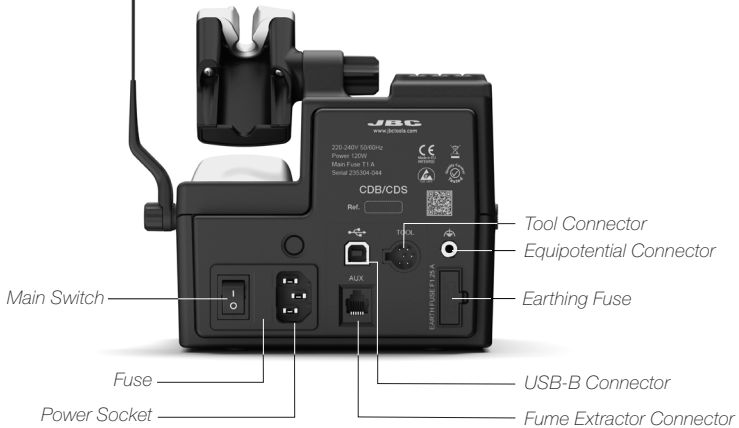

Adjust. Tool Holder

The position of the tool holder can be easily adjusted by loosening or tightening the knob. Tool holder ref. **H2994**.

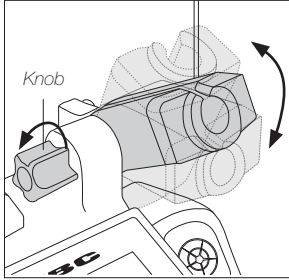

The metal top detects the tool and activates Sleep & Hibernation modes.

Cable Collector

The cable collector (ref. **CC1001**) keeps the cable away from the work area and prevents the weight of the cable from disturbing the operator while soldering.

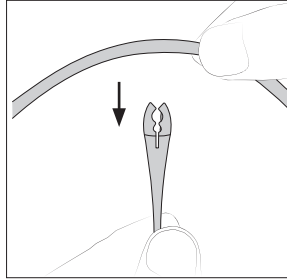

Insert the cable into the cable collector clip. Do not leave the cable longer than necessary to reach the work area freely.

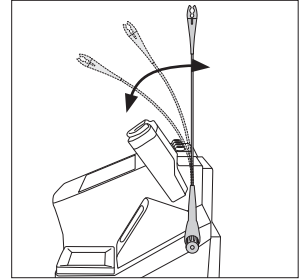

The cable collector is flexible. It accompanies and adapts to the movements during the soldering process.

Tip Cleaner

Select the option to suit your needs and improve the thermal transfer of the tip.

Splashguard

Ref. 0017576

Prevents the splashing of solder and wool particles.

CL7882

Antisplash Membrane

Prevents splashing and keeps the work area clean.

CL6210

Brass Wool

Very effective cleaning method. Leaves a small layer of solder on the tip preventing oxidation between cleaning and reflowing.

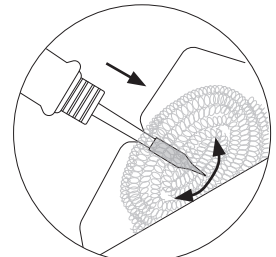
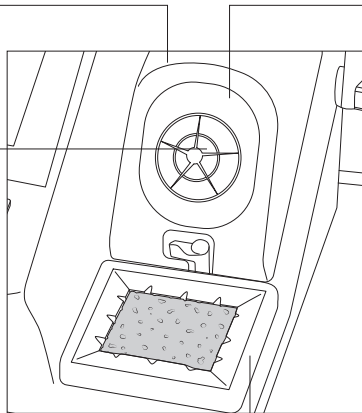

If the tip is very dirty, JBC recommends first cleaning it with the wiper to remove excess solder.

CL7984

Wiper

A temperature-resistant receptacle for removing excess solder by gently tapping or wiping.

Wool/Brush Replacement

1. Unlock the splashguard.

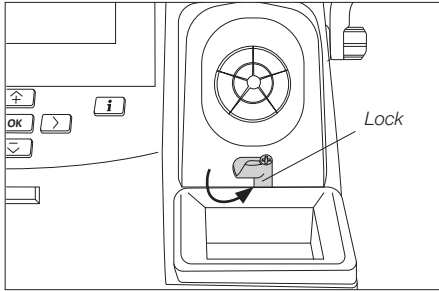

2. Lift off the splashguard and change the worn brasswool/brush for a new one.

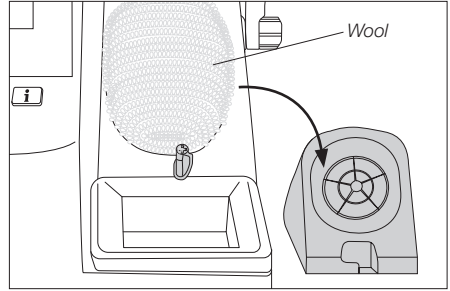

More cleaning options:

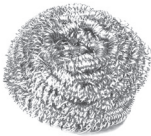

CL6205
Inox Wool*
*Stronger cleaning method than
brass wool.*

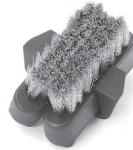

CL6220
Metal Brush*
*When used carefully, it provides
more thorough cleaning.*

CL7984
Wiper

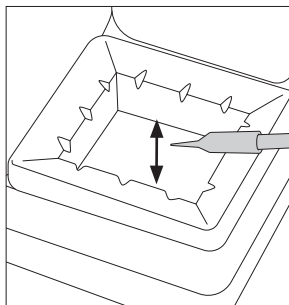

Tapping:
Tap gently to remove excess
solder.

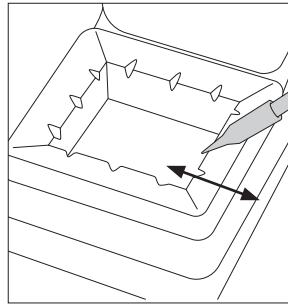

Wiping:
Use the slots to remove the
remaining particles.

S0354
Sponge

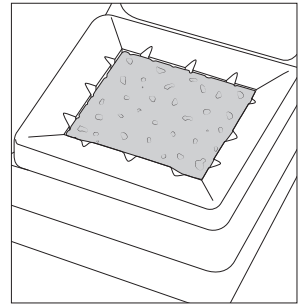

The softest cleaning method.
Keep the sponge damp with
distilled water when working to
avoid tip wear.

* not included, sold separately

Changing Grips*

Replace the soft foam grips easily using slip-on tabs. **Note:** Choose the correct grip depending on your handle model.

Handles	Green grips	Blue grips	Black grips
T210, T210P, T210N	T8658	T3310	T3311
T245, T245G, T245P	T6057	T1528	T1530

1. Inserting Tabs

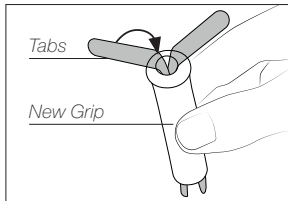

Put the slide-on tabs into the new grip.

2. Inserting Grip

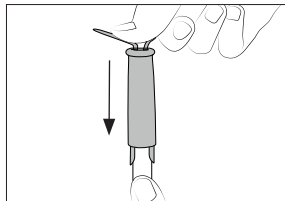

Push the grip with the tabs onto the handle.

3. Removing Tabs

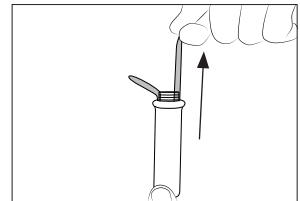

Hold the grip and pull the tab. Use pliers if necessary.

Replacing Sealing Plugs

The sealing plug prevents undesirable flux vapors or particles from entering the tool. Its usage is highly recommended for intensive applications when soldering is exposed to FOD environments or for applications where the soldering iron works close to a vertical position.

Note: Choose the correct sealing plug depending on your handle model.

Handles	Sealing Plug
T210	OB1000
T245, T470	OB2000

! Before replacing the sealing plug, unplug the power supply and make sure the device is not hot.

1. Removing Sealing Plug

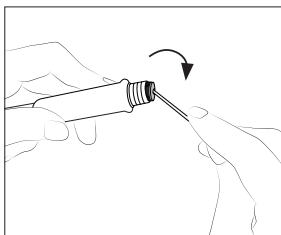

Enter a small shaft or screwdriver, not deeper than 8mm, and lift and pull the sealing plug. Never use a cartridge to do this operation.

2. Mounting Position

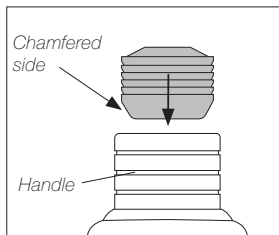

Note: The chamfered side has to be positioned towards the handle.

3. Inserting Sealing Plug

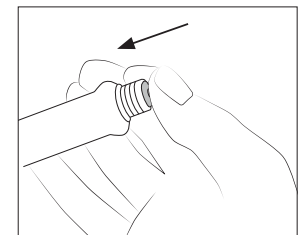

Push the sealing plug inside the handle until the sealing plug and handle edges are aligned.

* not included, sold separately

Cartridge Exchanger

Save time and change cartridges safely without switching the station off.

1. Removing

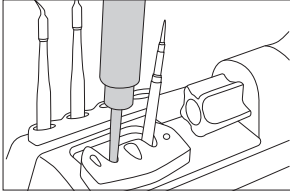

Place the handle in the extractor and pull to remove the cartridge.

2. Inserting

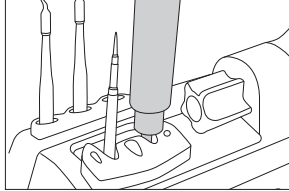

Place the handle on top of the new cartridge and press down slightly.

3. Fixing

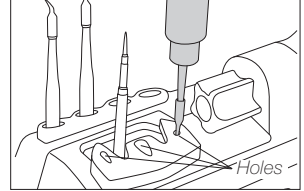

Depending on the shape of the tip, use one of the holes for fixing the cartridge.

***Important:** It is essential to insert the cartridges as far as the mark for a proper connection.



Compatible Cartridges

These stations work with C245 Cartridges and T245 Handles.
Find the model that best suits your soldering needs at www.jbctools.com

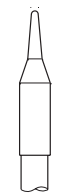

Conical



Chisel



Conical Bent



Bevel

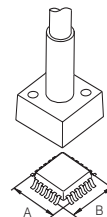

Special Models

Operation

JBC's Most Efficient Soldering System

This revolutionary technology is able to recover tip temperature extremely quickly. This allows the user to work at a lower temperature. As a result, tip life is five times longer than with other brands.

1. Work

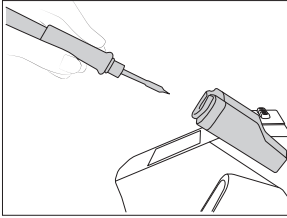

When the tool is lifted from the stand the tip will heat up to the selected temperature.

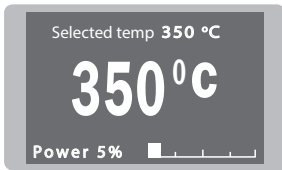

Tool Settings:
· *Operating Temp.*

Select temperature between 90 and 450 °C using:

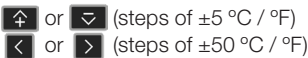

Tool Settings:
· *Temp. Levels*

Press , select *Tool Settings* and activate the *Temp. Levels* option.

Use  or  (steps of ± 5 °C / °F)

2. Sleep

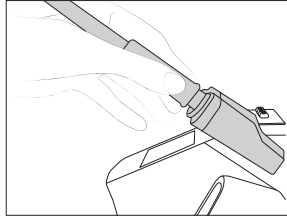

When the tool is in the stand, the temperature falls to the preset sleep temperature.



Tool Settings:
· *Sleep*

Change Sleep temperature and set Sleep delay from 0 to 9 min or no Sleep.

3. Hibernation

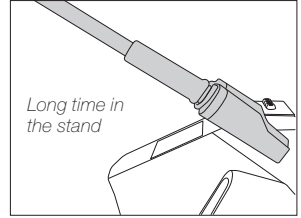

After longer periods of inactivity, the power is cut off and the tool cools down to room temperature.



Tool Settings:
· *Hibernation*

Change Hibernation delay from 0 to 60 min or no Hibernation.

Control Process

Work Display

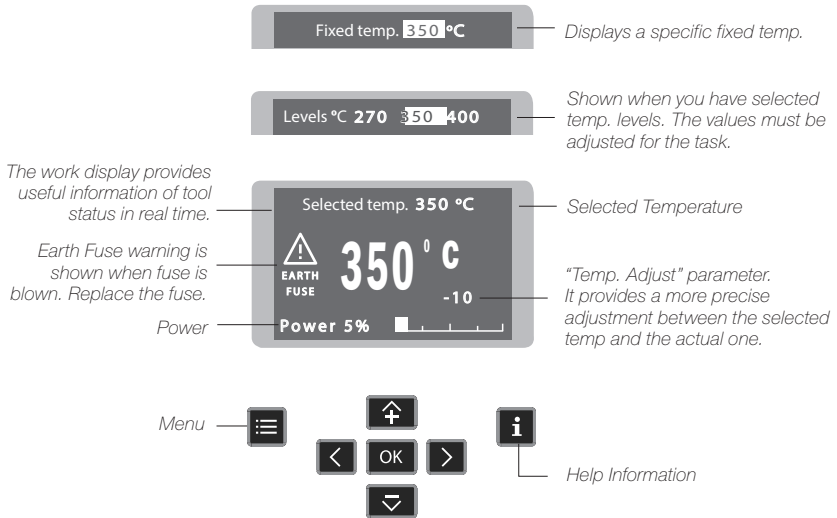

Troubleshooting

Station troubleshooting available on the product page at www.jbctools.com

Menu Display

Default PIN: 0105

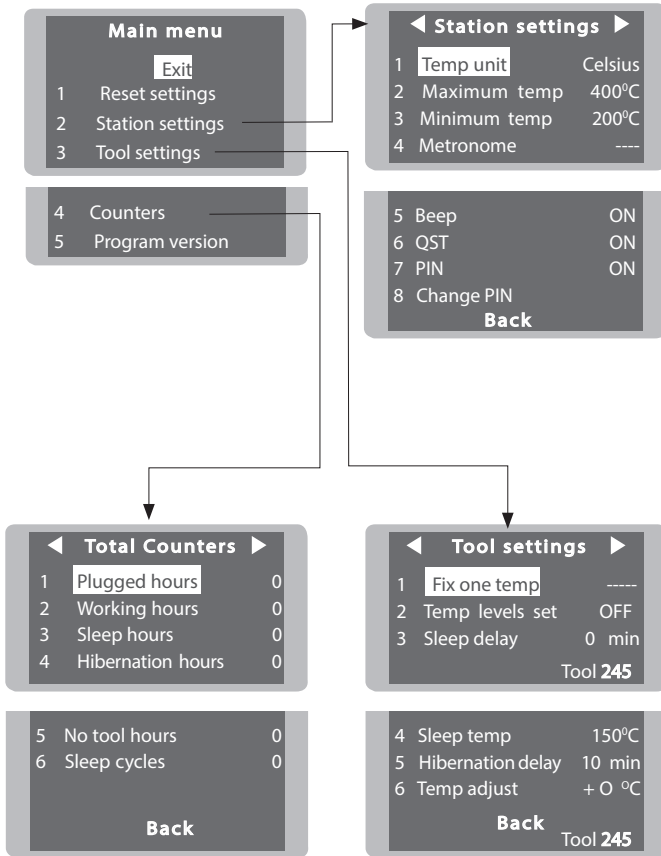

Parameters

Be careful when using these parameters as they may reduce the tip life if not used properly. Please follow the recommended guidelines:

Station Settings

Parameter Description	Recommendations	Warnings
Temperature Unit Celsius (°C) or Fahrenheit (°F)	N/a	N/a
Maximum Temperature Set the maximum temperature to work with. Default max. temp is 400 °C (750 °F). This is considered high enough to work with most lead-free applications.	The station temperature range is 90-450 °C (190-840 °F). Change the temperature limits when working with less common applications such as low / high melting point soldering (HMP) or plastics (e. g. riveting).	 In most cases, working with temperatures over 400 °C (750 °F) can damage the PCB and its components. Even in short time periods of tip contact with the soldering joint, the flux may not work properly and could seriously reduce tip life. If the solder joint requires more power (e.g. multilayered or high dissipation boards), JBC strongly recommends using other aids like preheaters.
Minimum Temperature Set the minimum temperature to work with. Default min. temp. is 200 °C (392 °F). This is considered to be a proper starting point for leaded applications.		
Metronome This activates a beep sound. Frequencies vary from 1 to 50 seconds.	Useful for setting a work rate in repetitive jobs. The beep lets you know the length of time the tip must be in contact with the soldering joint.	N/a
Beep Enable/disable the beep sound of the keypad.	N/a	N/a
Pin Enable/disable pin prompt.	N/a	N/a
Change Pin Change the default security PIN number (0105).	The PIN must be entered every time a parameter is changed.	N/a

Tool Settings

Parameter Description	Recommendations	Warnings
Fix One Temperature Fix a value within the temperature range of the station (90-450 °C/190-840 °F).	Ideal for soldering more than one component at a specific temperature. The station will reject any attempt to change the temperature.	N/a
Temperature Levels Set Similar to “Fix one temp” parameter. In this case, the user can set up to 3 values for different power requirements.	This allows a quick change between 3 different temperatures. Set them according to the allowed values for your soldering applications.	N/a
Sleep Delay Set the time that the tool will remain at the selected temperature when in the stand before entering Sleep mode. The tip temperature will then drop to the Sleep temperature.	Because our tools reach the working temperature from the default Sleep mode in only a few seconds, this parameter is preset to 0 min. Once the tool is returned to the stand, the temperature will automatically drop to Sleep temperature, extending tip life and avoiding oxidation. Retinning the tip before placing the tool in the stand will protect the tip and extend its life.	 Setting these parameters to higher values will unnecessarily accelerate oxidation and shorten tip life especially when working with temperatures up to 450 °C / 840 °F.
Sleep Temperature This is the set temperature the tip reaches when returned to the stand.	Sleep temperatures are set to achieve a balance between preventing oxidation and reaching the working temperature in a few seconds.	

Tool Settings

Parameter Description	Recommendations	Warnings
<p>Hibernation Delay Set the time the tool will remain at Sleep Temperature before entering in Hibernation Mode. At this time, the power supply is cut off and the tip remains at room temperature.</p>	<p>This function completely protects the tip from oxidation during long periods of inactivity while the tool is in the stand. Retinuing the tip before placing the tool in the stand also helps prevent oxidation and extends the life of the tip.</p>	<p> Increasing the default value will accelerate oxidation and shorten the tip life.</p>

<p>Temp Adjustment It provides a more precise adjustment between the selected temperature and the actual one.</p>	<p>Set values within ± 50 °C / ± 90 °F to achieve zero error. JBC strongly recommends the use of TID-A or TIA-A Thermometers to obtain precise readings.</p>	<p> When the user changes the cartridge type, the parameter should be reset to 0 °C/F or to the value needed for this cartridge. E.g. If a correction of +20 °C / +36 °F is set for a thick cartridge and then the user changes to a thinner one without resetting the temperature adjustment, he would be working at a higher temperature than needed for this thinner cartridge, which does not need any temperature adjustment.</p>
--	--	---

USB Connector

Download the latest software from our website to improve your soldering station.

JBC Updater

www.jbctools.com/software.html

Update the station software via USB connection:

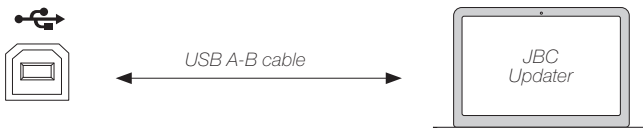

Maintenance

Before carrying out maintenance, always switch the device off and disconnect it from the mains. Allow the equipment to cool down.

- Clean the station display with a glass cleaner or a damp cloth.
- Use a damp cloth to clean the casing and the tool. Alcohol can only be used to clean the metal parts.
- Periodically check that the metal parts of the tool and the tool holder are clean so that the station can detect the tool's status.
- Maintain the tip surface clean and tinned before storage to avoid tip oxidation. Rusty and dirty surfaces reduce heat transfer to the solder joint.
- Periodically check all cables.
- Replace any defective or damaged pieces. Only use original JBC spare parts.
- Repairs should only be performed by a JBC authorized technical service.

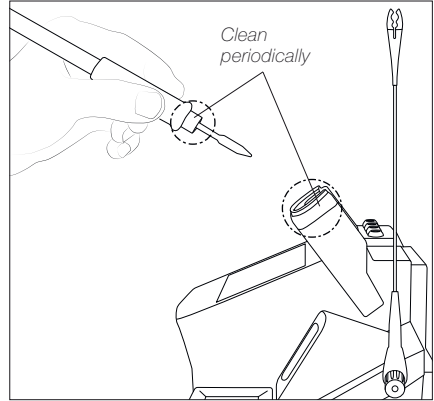

- **EARTH FUSE** When this warning appears on the main display, earthing fuse must be replaced.
- Replace a blown fuse as follows (applies to both the earthing fuse and the main fuse):
 1. Pull off the fuse holder and remove the fuse. If necessary, use a tool to lever it off.
 2. Insert the new fuse into the fuse holder and return it to the station.

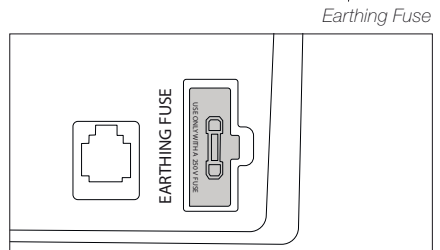
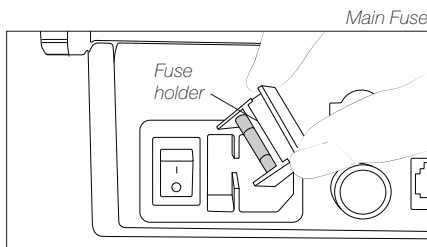

Safety



It is imperative to follow safety guidelines to prevent electric shock, injury, fire or explosion.

- Do not use the units for any purpose other than soldering or rework. Incorrect use may cause a fire.
- The power cord must be plugged into approved bases. Be sure that it is properly grounded before use. When unplugging it, hold the plug, not the wire.
- Do not work on electrically live parts.
- The tool should be placed in the stand when not in use in order to activate the sleep mode. The soldering tip or nozzle, the metal part of the tool and the stand may still be hot even when the station is turned off. Handle with care, including when adjusting the stand position.
- Do not leave the appliance unattended when it is on.
- Do not cover the ventilation grills. Heat can cause inflammable products to ignite.
- Avoid flux coming into contact with skin or eyes to prevent irritation.
- Be careful with the fumes produced when soldering.
- Keep your workplace clean and tidy. Wear appropriate protection glasses and gloves when working to avoid personal harm.
- Utmost care must be taken with liquid tin waste which can cause burns.
- This appliance can be used by children over the age of eight and also people with reduced physical, sensory or mental capabilities or lack of experience provided that they have been given adequate supervision or instruction concerning the use of the appliance and understand the hazards involved. Children must not play with the appliance.
- Maintenance must not be carried out by children unless supervised.

Specifications

CDB

Soldering Station

Ref.: **CD-9BQF** 100V 50/60Hz. Input fuse: T2A. Output: 23.5V.

Ref.: **CD-1BQF** 120V 50/60Hz. Input fuse: T2A. Output: 23.5V.

Ref.: **CD-2BQF** 230V 50/60Hz. Input fuse: T1A. Output: 23.5V.

- Nominal Power 175W
- Peak Power (tool): 130W
- Selectable Temperature: 90 - 450 °C / 190 - 840 °F
- Idle Temp. Stability (still air): ± 1.5 °C / ± 3 °F (Meets and exceed IPC J-STD-001)
- Temp. Accuracy: $\pm 3\%$ (Using reference cartridge)
- Temp. Adjustment: ± 50 °C / ± 90 °F (Through station menu setting)
- Tip to Ground Voltage/Resistance: Meets and exceed
ANSI/ESD S20.20-2014 IPC J-STD-001F
- Earthing Fuse: F 1.25A
- Connections: USB connector station-PC
RJ12 Connector
- Ambient Operating Temp: 10 - 50 °C / 50 - 122 °F
- Control Unit Dimensions / Weight:
(L x W x H) 170 x 176 x 145 mm / 2.74 kg
6.69 x 6.93 x 5.71 in / 6.04 lb
- Total Net Weight: 3 kg / 6.61 lb
- Total Package Dimensions / Weight:
(L x W x H) 234 x 234 x 258 mm / 3.34 kg
9.21 x 9.21 x 10.16 in / 7.36 lb

Complies with CE standards.

ESD safe.

JBC

Warranty

JBC's 2 year warranty covers this equipment against all manufacturing defects, including the replacement of defective parts and labour.

Warranty does not cover product wear or misuse.

In order for the warranty to be valid, equipment must be returned, postage paid, to the dealer where it was purchased.

Get 1 extra year JBC warranty by registering here:
<https://www.jbctools.com/productregistration/>
within 30 days of purchase.



This product should not be thrown in the garbage.

In accordance with the European directive 2012/19/EU, electronic equipment at the end of its life must be collected and returned to an authorized recycling facility.

CE EAC UK
CA

www.jbctools.com

0026943-210324