

# JBC

[www.jbctools.com](http://www.jbctools.com)

## INSTRUCTION MANUAL



### FAE1

Fume Extractor for 1 Workbench

This manual corresponds to the following references:

**FAE1-1B** (100V/120V))

**FAE1-2B** (230V)

## Packing List

The following items are included:



**Fume Extractor for 1 Workbench** .... 1 unit



 *Unseal the filter  
before its first use*

**Filter for FAE1** ..... 1 unit  
Ref. FAE1-100 (*already assembled*)



**Premium Station Cable (RJ12)** ..... 2 units  
Ref. 0019751



**Power Cable** ..... 1 unit  
Ref. 0023715 (100V / 120V)  
0023714 (230V)



**Compact Station Cable (USB A/B)** ..... 1 unit  
Ref. 0021042



**Compact Station Adapter  
(RJ12 to USB A)** ..... 1 unit  
Ref. 0023504



**Manual** ..... 1 unit  
Ref. 0027634

## Features and Connections

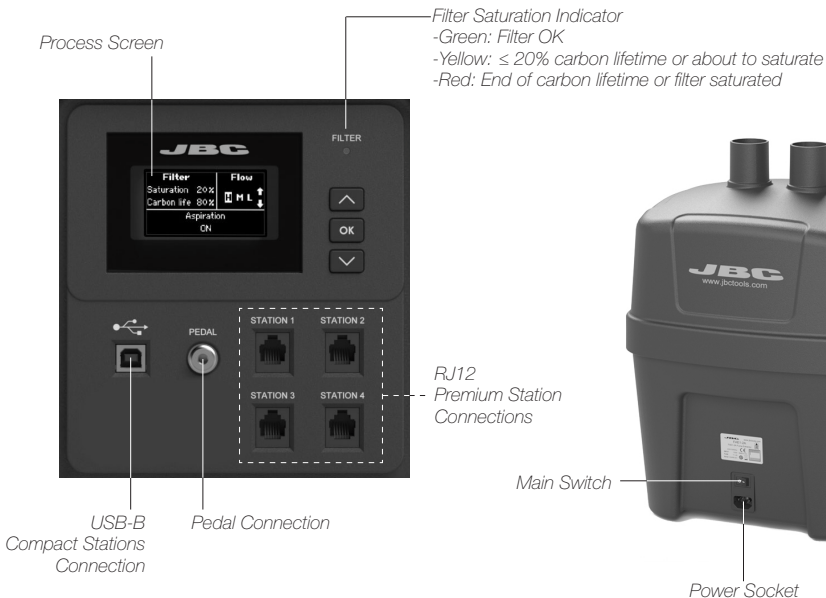

# Assembly Options

## 1 Workbench Configuration *(default)*

### Flexible Arm Ø50

Ref. FAE070

Length: 1 m / 39.37 in

*To be assembled on your workbench with the included clamp*

Ref. FAE020

Length: 1 m / 39.37 in

*To be assembled directly on your workbench (hole drilling required)*

### Stand

**Aspiration Duct**  
Ref. FAE050

*For modular stands (from SD versions onwards)*

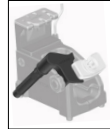

Ref. FAE060

*For compact stations (from B versions onwards)*



**Accessory for Stand Aspiration**  
Ref. FAE040

*To be assembled on your workbench with the included clamp (for up to 4 stands)*

Ref. FAE030

*To be assembled directly on your workbench (hole drilling required)*

### Flexible Hoses Ø50

Ref. FAE010

Length: 1,5 m / 59.05 in

*Connect the Fume Extractor indifferently to the flexible arm or to the accessory for stand aspiration*

### Attention

*Avoid awkward positions in order to minimize pressure losses*

### Fume Extractor

Ref. FAE1-1B (100V / 120V)

FAE1-2B (230V)

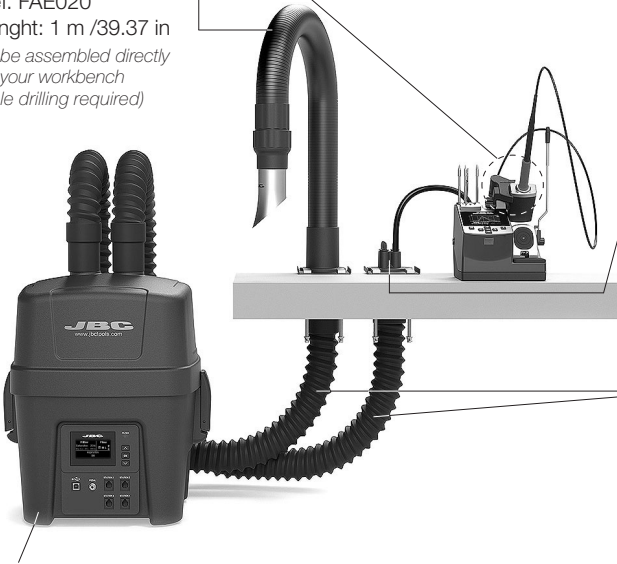

## Main Screen

Access by  and  to change the aspiration program.

Preset program screen

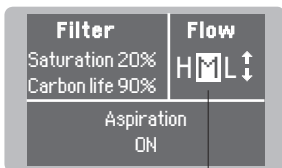

*High, medium and low aspiration programs*

Custom program screen

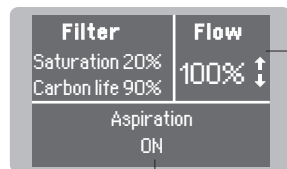

*Aspiration status*

*Flow rate*

## 2 Workbenches Configuration *(optional)*

This configuration is activated by setting Workbench option to “2” in the FAE1 main menu.

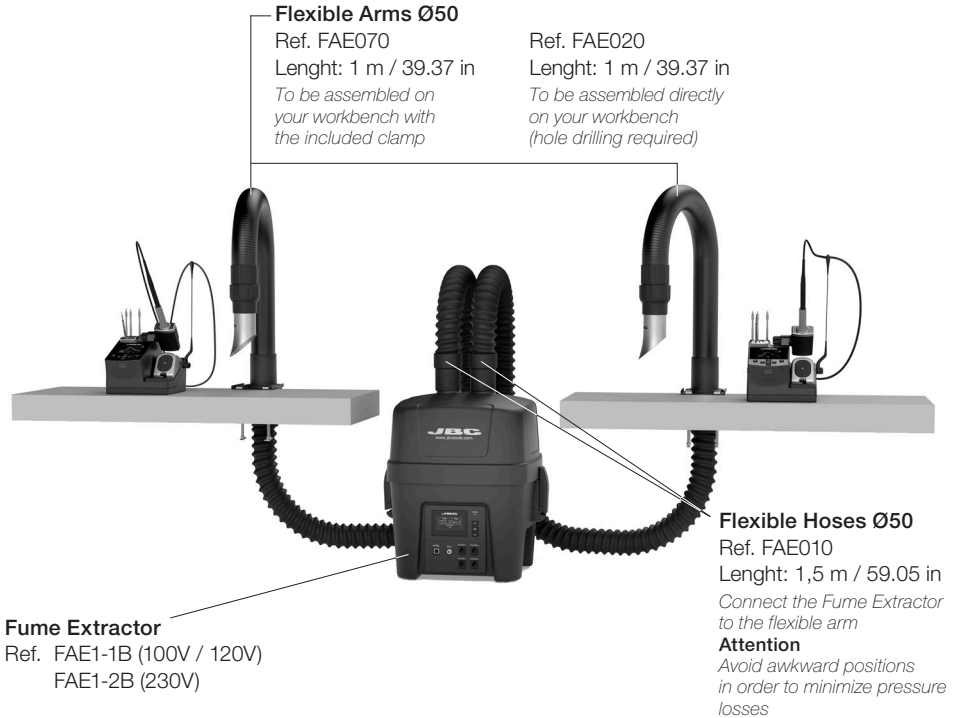

## Main Screen

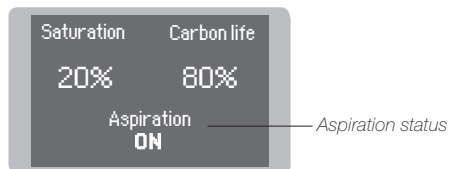

**Note:** For this configuration stand aspiration is not available and aspiration flow is set “High”. The suction force per intake decreases compared with 1 workbench configuration (see page 14).

# Station Connections for Premium Range

JBC Soldering Stations feature a robot port to the fume extractor in order to automatically activate the extraction when the tools are in use. Use the Premium Station Cable (included) for the connection.



Connect up to 4 stations directly to a fume extractor through the soldering station robot port. Every tool connected to a station can control the aspiration system.

Each Station detects the fume extractor as "FAE\_a". The tool that should activate the fume extraction need to be configured through the peripheral menu option on the station menu.

## Peripherals Menu

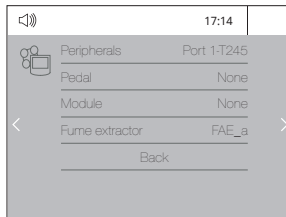

**Note:** For a correct operation always update soldering stations with the latest available software version. The minimum required version is 8886160 for DDE, HDE and NAE stations and 8886162 for DME stations.

## Station Connections for Compact Range

Use the Compact Station Cable and the Adapter cable to connect JBC Soldering Stations. They feature a USB-B port to the fume extractor in order to automatically activate the extraction when the tools are in use.

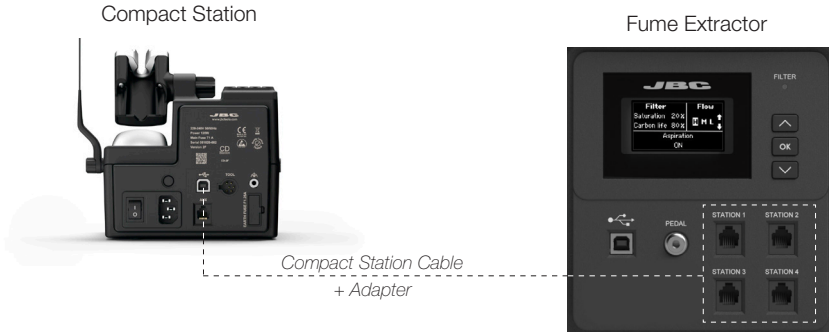

## Equipment Software Update

### JBC Updater

The fume extractor can be updated via the USB-B connection by means of JBC Updater software. Download software from: [www.jbctools.com/software.html](http://www.jbctools.com/software.html).

**Note:** For the updating process the Premium Station Cable (RJ12) has to be disconnected. If a station is connected to RJ12 connector the update process will not start.



# Menu Interface

## Main Menu Parameters

Original PIN: 0105

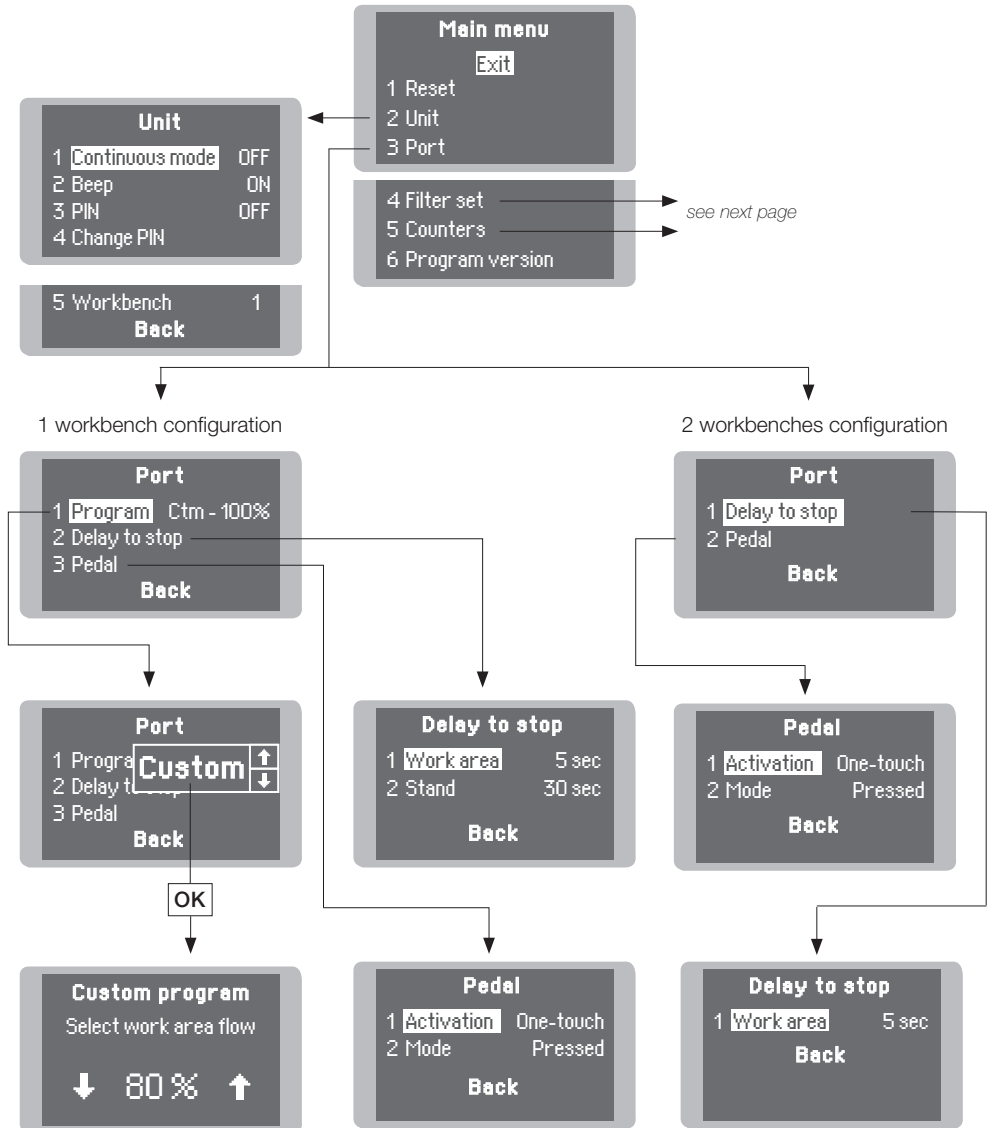



## Menu Interface

### Main Menu Parameters

Original PIN: 0105

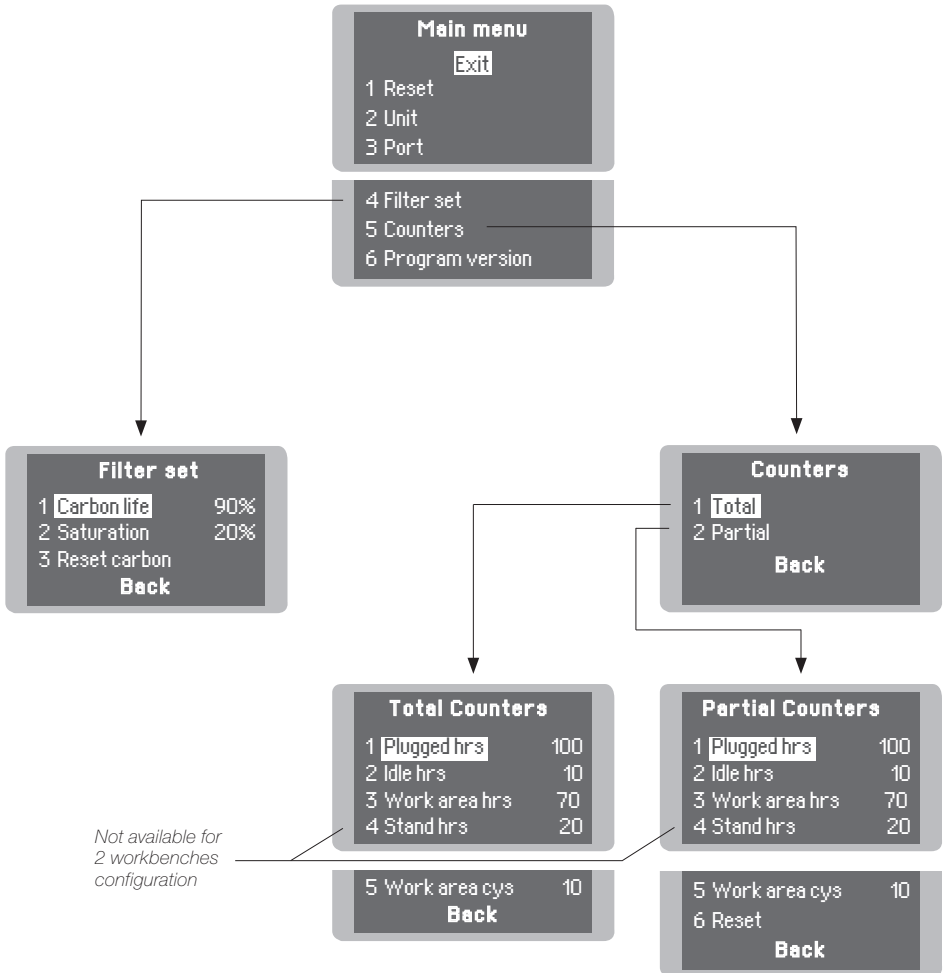

# Fume Extractor Activation

Once the fume extractor is turned on, the display shows a similar screen as the following one and the filter saturation indicator is green if the carbon filter lifetime is higher than 20%.

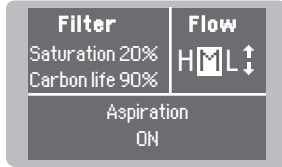

- Green: Filter OK
- Yellow: ≤ 20% carbon lifetime or about to saturate
- Red: End of carbon lifetime or filter saturated

If the display shows STOP#4, power off the fume extractor, remove the cover, place it back and secure it by using the quick release levers.



## Troubleshooting

Station troubleshooting available on the product page at [www.jbctools.com](http://www.jbctools.com)

## Parameters

 **Important: Power off soldering stations connected to the fume extractor before modifying any parameter.**

### Unit

Parameter	Description
Continuous mode	Enable/disable continuous aspiration. Fume extractor aspirations remains active independently from tool or pedal status.
Beep	Enable/disable the sound of the keypad.
PIN	Enable/disable PIN request when modifying parameters.
Change PIN	Change the default security PIN code. Default PIN 0105
Workbench	Select working mode for 1 or 2 workbenches (see page “Menu Interface”).

## Port

---

### Parameter

### Description

---

Program	<p>It sets the fume extractor aspiration flow. You can select between preset and custom aspiration programs.</p> <p>H (High), M (Medium) or L (Low) are the three available preset options. Use UP and DOWN keys to switch between them while being on the main screen.</p> <p>Up to ten aspiration levels between H (High) and L (Low) can be selected for custom program (range 10-100%). If a custom aspiration program is selected, the selected aspiration level can be changed on the main screen. By default M (Medium) aspiration program is selected.</p>
Delay to stop / Stand	<p>It sets the time that a fume extractor keeps aspirating fumes at the stand once the tool is returned to it (range 0-999 seconds)</p> <p>By default stand time is 60 seconds.</p>
Delay to stop / Work area	<p>It sets the time that a fume extractor keeps aspirating fumes at the work area once the tool is returned to the stand (range 0-300 seconds).</p>
Pedal / Activation	<p>It sets the pedal activation mode. There are two different modes: "pressed" and "released".</p> <p><b>One-touch:</b> Press the pedal once to activate aspiration. Press again to stop aspiration.</p> <p><b>Pressed:</b> (Mode function must be pressed) aspiration is active as long as the pedal is kept pressed.</p> <p>By default activation is pressed.</p>
Pedal / Mode	<p>When the activation parameter is set to pressed, the mode parameter can be configured to released mode. In this mode aspiration is always active until the pedal is pressed.</p> <p>By default mode is pressed.</p>

---

## Filter Set

Parameter	Description
Carbon life	It shows remaining activated carbon lifetime expressed in %. It is also displayed on the main screen. When 0% is reached the system will show pop-up message STOP#1 to replace the filter.
Saturation	It shows saturation status of HEPA + carbon filter set, expressed in %. It is also displayed on the main screen. When 100% is reached the system will show pop-up message STOP#2 to replace the filter.
Reset carbon	Perform this action after replacing the HEPA + carbon filter set. The carbon lifetime counter will not start until the filter is detected for the first time. After executing that function carbon filter life will be 100%.

## Extraction Control

Fume extractor aspiration may be controlled by:

### Pedal Connection

By means of the pedal connection, fume extractor aspiration may be activated/deactivated by P-005 or P-405 pedal. (See pedal activation modes on previous page)



## Fume Extractor Configurations

Some parameters, features and the performance vary depending on fume extractor configuration, see the following table:

<b>230V 50/60Hz</b>	<b>Mode: 1 Workbench</b>	<b>Mode: 2 Workbenches</b>
Flexible Arm Aspiration Intake	1	2
Stand Aspiration Intake	1	Not available
Flow per Flexible Arm Intake	80 m <sup>3</sup> / h (47.08 cfm)	60 m <sup>3</sup> / h (35.31 cfm)
Preset Aspiration Programs	3	1
Custom Aspiration Programs	10	Not available
Power consumption	110 W	115 W

<b>120V 50/60Hz</b>	<b>Mode: 1 Workbench</b>	<b>Mode: 2 Workbenches</b>
Flexible Arm Aspiration Intake	1	2
Stand Aspiration Intake	1	Not available
Flow per Flexible Arm Intake	80 m <sup>3</sup> / h (47.08 cfm)	60 m <sup>3</sup> / h (35.31 cfm)
Preset Aspiration Programs	3	1
Custom Aspiration Programs	10	Not available
Power Consumption	115 W	135 W

<b>100V 50/60Hz</b>	<b>Mode: 1 Workbench</b>	<b>Mode: 2 Workbenches</b>
Flexible Arm Aspiration Intake	1	2
Stand Aspiration Intake	1	Not available
Flow per Flexible Arm Intake	75 m <sup>3</sup> / h (44.14 cfm)	55 m <sup>3</sup> / h (32.37 cfm)
Preset Aspiration Programs	3	1
Custom Aspiration Programs	10	Not available
Power Consumption	100 W	105 W

# Maintenance and Filter Replacement

- The unit notifies through both the display and the LED when filters need maintenance.
- To replace the filters remove the cover by opening the quick release levers of the casing.
- If the saturation indicator remains in red after changing the pre-filter, it means that HEPA filter is already saturated and must be replaced too (see image below).
- When the HEPA filter has been replaced, the carbon filter counter must be reset (Main Menu > Filter Set > Reset Carbon).
- The duration of the compact filter is maximum 1 year after its packaging is opened.
- If the filter is changed while the fume extractor is on, the unit starts the filter detection process, activating aspiration for a few seconds.

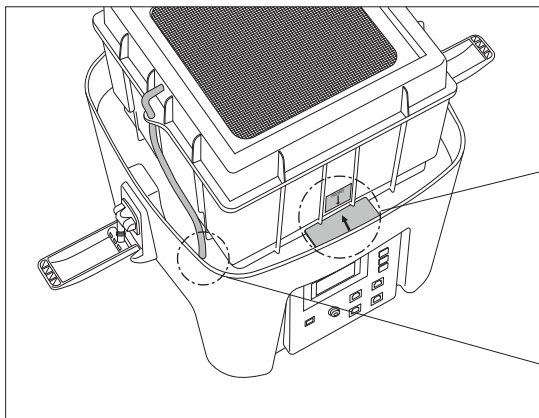

 The filter has a given position. Make sure the filter ribs mate with the corresponding slots.

Connect the filter tube to the quick coupling placed on the metal sheet

## Quick Release Lever Adjustment

- Turn clockwise to loosen and counterclockwise to tighten, in order to adjust the filter airtightness.

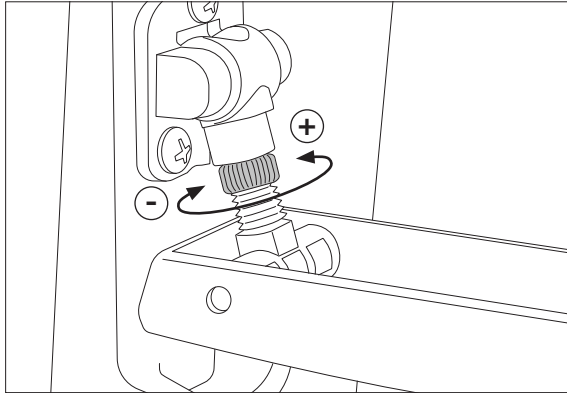

## Accessories

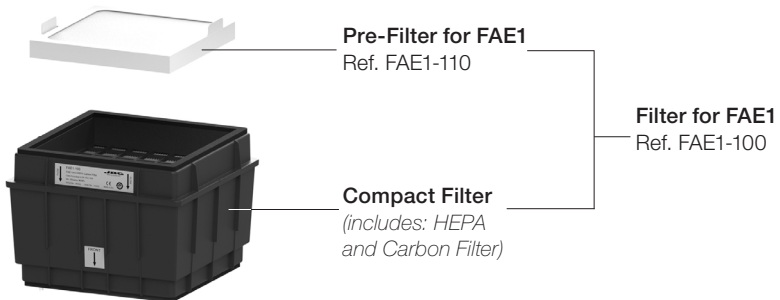

Read the safety guidelines to do the equipment maintenance safely.

# Safety



**Follow safety guidelines to prevent electric shock, injury, fire or explosion.**

- The equipment is only designed to filtrate the fumes generated by soldering.
- Do not use the units for the filtration of combustible, explosive or corrosive gasses. Incorrect use may cause fire.
- The power cord must be plugged into approved bases. Be sure that it is properly grounded before use. When unplugging it, hold the plug, not the wire.
- Do not leave the appliance unattended when it is on.
- Do not cover the ventilation grills. Heat can cause inflammable products to ignite.
- This appliance can be used by children over the age of eight and persons with reduced capabilities or lack of experience provided that they have been given adequate supervision or instruction concerning use of the appliance and understand the hazards involved.
- Maintenance must not be carried out by children unless supervised.
- Keep your workplace clean and tidy. Wear appropriate protective mask, glasses and gloves when handling dirt filter or pre-filter.
- Do not use the equipment without the filters.
- Saturated filters can not be cleaned and reused.
- Avoid blowing the filter or the dirty parts of the equipment, if necessary it is advisable to vacuum.
- Avoid losing particles in the filter during handling it.
- Treat the saturated filters as waste depending on the filtered contaminant and the applicable standards in each country. This is the European Waste Catalog classification:
  - 15 02: Absorbents, filter materials, wiping cloths and protective clothing.
  - 15 02 02: Absorbents, filter materials (including oil filters not otherwise specified), wiping cloths, protective clothing contaminated by dangerous substances.
  - 15 02 03: Absorbents, filter materials, wiping cloths and protective clothing other than those mentioned in 15 02 02.
- In case of not complying with the filter change recommendations, the maximum particle and gas concentrations established in each country could be exceeded.



**Notes**

---

---

---

---

---

---

---

---

---

---

---

---

---

---

---

---

---

---

---

---

---

---

---

---

---

---



## Specifications

### **F AE1**

#### **Fume Extractor for 1 Workbench**

Ref.: **F AE1-1B** 100V 50/60Hz. Input power: 105W. Fuse 2A

120V 50/60Hz. Input power: 135W. Fuse 2A

Ref.: **F AE1-2B** 230V 50/60Hz. Input power: 115W. Fuse 1.25A

- |   |  |
|---|--|
| - Blower Type:                                      | Brushless  |
| - Blower max. Flow Rate:                            | 180 m <sup>3</sup> /h (106 CFM)                                      |
| - Blower max. Vacuum:                               | 3.2 kPa (0.46 psi)   |
| - Work Areas (Workbenches):                         | 1 or 2   |
| - Noise:  | 55 dB @ 1m   |
| - Pre-Filter:                                       | Medium dust filter M5 (EN 779)                                       |
| - Compact Filter:                                   | HEPA filter H13 (EN 1822)<br>Carbon filter                           |
| - Connections:                                      | USB-B<br>Pedal connector<br>Station connectors (4x)                  |
| - Total Net Weight:                                 | 10.50 kg / 23.15 lb  |
| - Total Package Dimensions / Weight:<br>(L x W x H) | 425 x 425 x 545 mm / 12.76 kg<br>16.73 x 16.73 x 21.46 in / 28.13 lb |

Complies with CE standards.

ESD safe.

# JBC

---

## Warranty

JBC's 2 year warranty covers this equipment against all manufacturing defects, including the replacement of defective parts and labour.

Warranty does not cover product wear or misuse.

In order for the warranty to be valid, equipment must be returned, postage paid, to the dealer where it was purchased.

**Get 1 extra year JBC warranty by registering here:**  
<https://www.jbctools.com/productregistration/>  
**within 30 days of purchase.**

---



This product should not be thrown in the garbage.

In accordance with the European directive 2012/19/EU, electronic equipment at the end of its life must be collected and returned to an authorized recycling facility.



[www.jbctools.com](http://www.jbctools.com)

0027634-090323