



**JBC**

The Soldering Co.

## **Cartridge Guide**

Feel the quality, be exclusive

## Index

---

Most Efficient Soldering System.....	4
Bigger is better .....	6
Factors limiting tip life .....	7
Tip Cleaning Systems .....	8
<b>C115</b> Cartridge Range for NT115, AN115 and NP115 Nano Tools.....	12
<b>C120</b> Cartridge Range for PA120 and AM120 Micro Tweezers.....	16
<b>C210</b> Cartridge Range for T210, B-100 and B-500 Handles .....	18
<b>C245</b> Cartridge Range for T245 General Purpose Handles.....	22
<b>C245L</b> Longer Cartridge Range for T245 General Purpose Handles.....	39
<b>C245E</b> Extended Tip Life Cartridge Range for T245 General Purpose Handles .....	45
<b>C250</b> Cartridge Range for ALE250 Auto-Feed Iron and AP250 Solder Feed Iron .....	47
<b>C250E</b> Extended Tip Life Cartridge Range for ALE250 Auto-Feed Iron and AP250 Solder Feed Iron .....	49
<b>C420</b> Cartridge Range for AT420 and HT420 Thermal Tweezers.....	50
<b>C470</b> Cartridge Range for T470 HD Handles and HT470 HD Thermal Tweezers .....	52
<b>C360</b> Tip Range for DS360 Micro Desoldering Iron .....	60
<b>C560</b> Tip Range for DR560 Desoldering Iron.....	62
<b>W140</b> Blade Cartridge Range for WS140 Precision High-Temperature Wire Stripper Tweezers .....	64
<b>W440</b> Blade Cartridge Range for WS440 High-Temperature Wire Stripper Tweezers .....	66

# JBC Technology

## Most Efficient Soldering System

JBC Stations work with JBC Most Efficient Soldering System, which **recovers tip temperature extremely quickly**. This increases work efficiency and allows the user to work with lower temperatures.

**Efficient Temperature Control**  
Comparative process of 3 solder joints

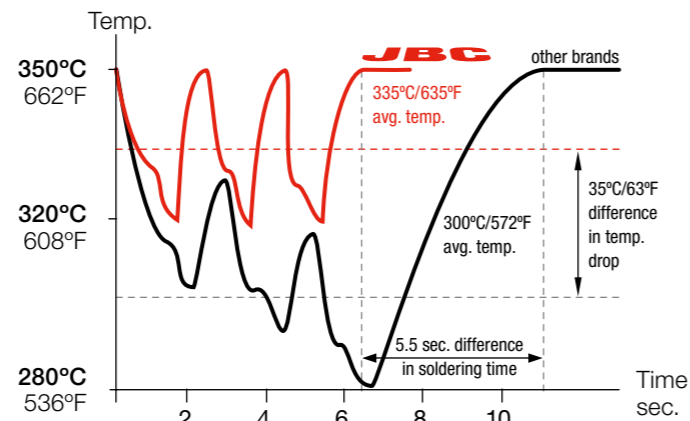

Tips with JBC Technology only drop 30°C (54°F) where others drop as much as 70°C (126°F).

Enhanced Temperature Efficiency → Increased Productivity + Better Quality

## Productivity

Short tip-to-sensor distance ensures extremely quick temperature recovery and an **accurate control**.

**Heating System Principles**  
350°C/662°F in 2 seconds

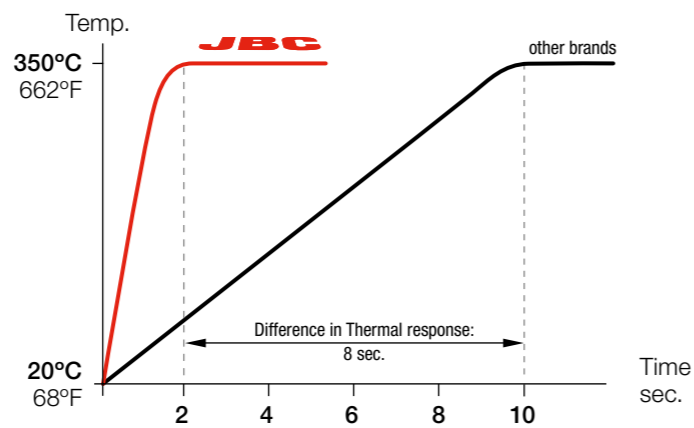

This graph compares JBC C210 Cartridge Range to the equivalent cartridges of the best competitor.

## Intelligent Heat Management

Thanks to automatic detection of the tool in the stand, JBC Soldering & Rework Stations allow the tools to enter **Sleep & Hibernation Modes** when not being used. As a result, tip life lasts up to 5 times longer.

### Sleep Mode

Sleep Mode **automatically lowers tip temperature** below the solder melting point when the tool rests in the stand. **It prevents the dissolution of the iron tip coating into molten solder.**

### Hibernation Mode

After a configurable period of tool inactivity in the stand, the tool enters Hibernation Mode. **It cuts off the power supply** making the tip reach room temperature, thus **preventing oxidation and saving energy.**

### Longer Tip life

Tip life increases exponentially by **using lower temperatures** as shown. Using Sleep Mode, the temperature is further reduced, which **multiplies tip life by 5.**

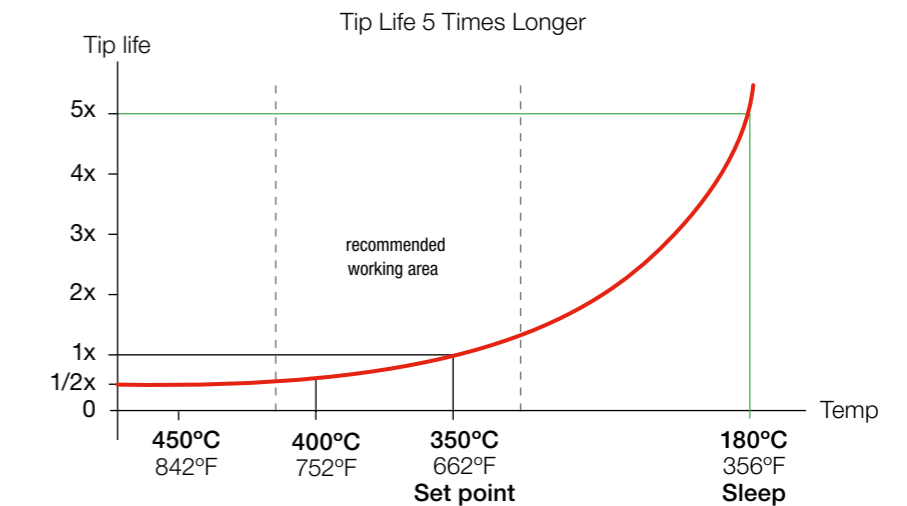
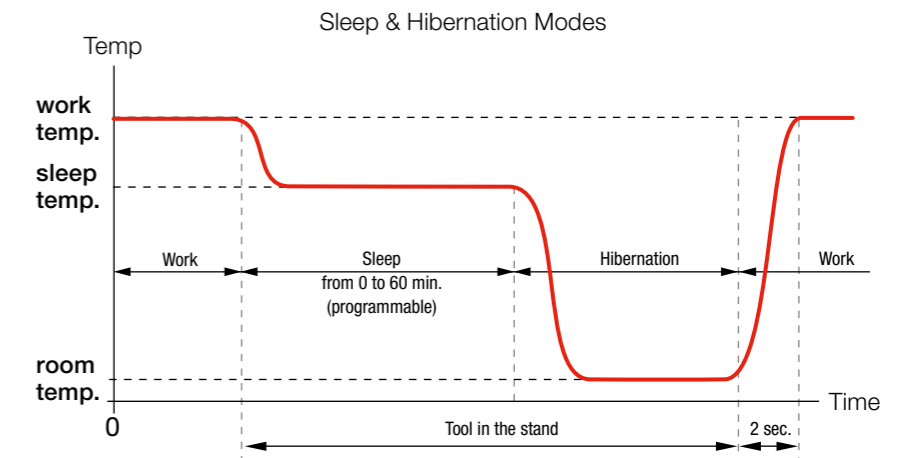

## Cartridges with long life & extended tip life

The essential part of the soldering iron is the tip. Therefore, JBC has **over 500 cartridge models of different shapes and sizes** to choose from, depending on each application. JBC has developed the most advanced technology based on the following principles:

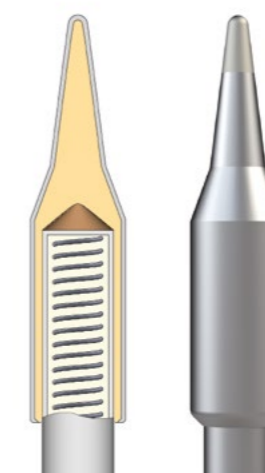

- **Excellent Heat Transfer**  
The compact element reduces thermal barriers.
- **Instantaneous Heating**  
A fully-integrated thermal sensor in the heater ensures quick temperature recovery.
- **Great Durability**  
The intelligent algorithm control program extends tip life.

### A global organization at your service

JBC is a global company with a distributor network spanning 5 continents that guarantees a solid commercial organization with quick and efficient service.

### The power of experience

More than 90 years of experience have placed JBC at the technological forefront of tools for soldering and rework operations in electronics. Innovation, efficiency and reliability are the key features of a wide range of products which have been designed to satisfy the most demanding requirements of professionals.

### High technology, superior quality

Product perfection is one of the main objectives of JBC's improvement and development program. The R&D department has created the most innovative soldering technologies, which JBC is proud to present in this catalogue.



All JBC products comply with CE standards and ESD recommendations.



When you start working do not forget:

## Bigger is better

The bigger the solder tip, the better the thermal transfer. Select the tip that has the greatest contact area.

### Over 500 tips of different sizes, shapes and power

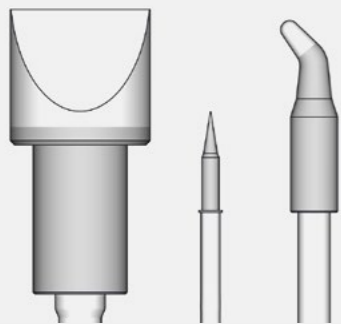

JBC Cartridges range from models for precision work to high power requirement applications.

### Geometry Slimness vs Efficiency

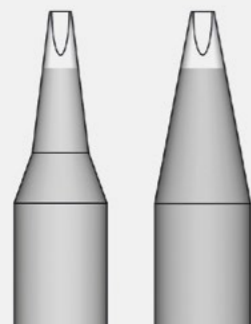

A tip with high-thermal efficiency makes your job up to **40% faster** than a tip with a slimmer geometry.

### Increase the contact surface Tip - Application

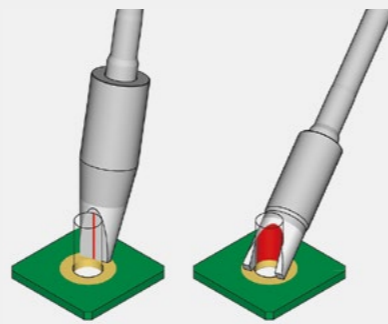

The bigger the contact surface that the tip has with the application, the higher the **thermal transfer**.

### Largest mass possible

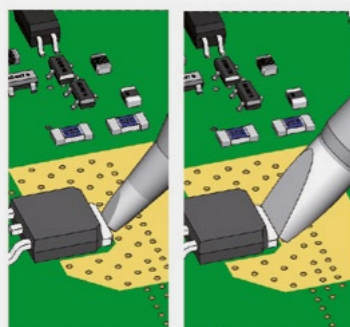

The more mass the tip has, the more heat is accumulated and the **lower is the temperature drop**.

### Maintain tip surface clean and tinned



Remember that rusty and dirty surfaces reduce **heat transfer** to the solder joint.  
*(See JBC's cleaning methods on pages 8-9).*

This way you will be able to:

- Work at **lower temperatures** (350°C / 662°F).
- Obtain **better results** in **less time**.
- Improve **thermal performance**.
- Increase **temperature precision**.
- Reduce **collateral damage** (thermal shock on components and PCBs).

## Factors limiting tip life

### Working temperature

The higher the temperature, the greater the oxidation and corrosion. Work with the **lowest possible temperature** and choose the tip with the greatest contact area for each application. **Use thermally efficient tools** and keep tips clean of oxidation.

### Correct techniques

Too much pressure on the surface to solder can cause tip or plate breakage. Do not use the tip as a pointed object or a screwdriver. Choose the **right temperature and tip shape for each application**.

### Iron plate thickness

Iron plate wear shortens tip life by hollowing tips out. Do not use mechanical or chemical means to clean the tip. Use the **cleaning methods provided by the manufacturer** - such as brass wool, automatic tip cleaner or sponges.

### Oxidization

An oxidized soldering iron does neither wet nor transfer heat well (dewetting). The higher the temperature, the greater the risk of oxidation. **Always keep tips tinned while not in use** and take advantage of **JBC Sleep & Hibernation Modes**.

### Flux and solder alloy

Too much active flux can cause corrosion. **IPC recommends: ROL, REL and ORL**. Flux quantity inside small diameter solder wires might not be enough. **Provide compatible external flux if necessary**.

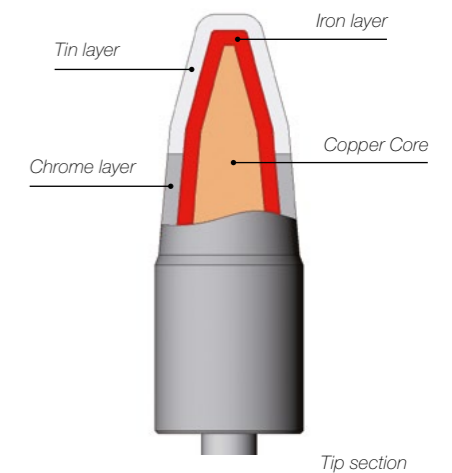

Tip section



### Remember:

- Work with the **lowest possible temperature**.
- Use **thermally efficient tools**.
- Choose the **right temperature and tip shape for each application**.
- **IPC recommends: ROL, REL and ORL**.
- **Always keep tips tinned while not in use**.
- Take advantage of **JBC Sleep & Hibernation Modes**.
- **Too much pressure** on the surface to solder can cause **tip or plate breakage**.
- Use the **cleaning methods provided by the manufacturer**.

# Cleaning Systems

For good thermal transfer, keep the tip tinned thus free from oxides.

Clean the tip in less than a second



With automatic cleaners you **save time** and optimize production.

Improve heat transfer

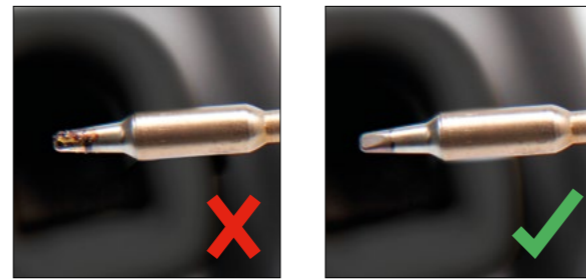

A clean tip is always easier to tin, resulting in **higher quality solder joints**.

## CL Manual Tip Cleaner

A complete cleaning system with splashguard and antisplash membrane to keep the workspace clean and free of solder particles.



### Cleaning Methods

**CL6210**  
**Brass Wool**  
Very effective cleaning method. It leaves a small layer of solder on the tip to prevent oxidation between cleaning and rewetting.



**S0354**  
**Sponge**  
The least harmful cleaning method. Keep the sponge moist with distilled water when working to avoid tip wear.



## CLMS Automatic Junior Tip Cleaner with Fiber Brushes (non-metal)

The ideal partner to any soldering station.

### Two modes of operation

The motorized brushes start by pushing the button or by selecting the continuous mode.

Splashguard



### Save space

You can easily fit the tip cleaner into your workspace thanks to its reduced size.

### Brushes

**CL4008**  
**Fiber Brushes**  
The composition, size and thickness of the fibers ensure the **most efficient cleaning** and the least damage while cleaning the tip.



## Automatic Tip Cleaners

### CLMUP

**Automatic Tip Cleaner with Fiber Brushes (non-metal)**  
Perform a thorough and **gentle tip cleaning** increasing heat transfer and maximizing the soldering quality.

### CLMU

**Automatic Tip Cleaner with Metal Brushes**  
Perform a thorough and **strong cleaning** to recover the tip increasing heat transfer. The metal brushes supplied provide a **deep cleaning**.



### Sensor Mode

The sensor triggers brush rotation when tip approaches and automatically stops when the tip is removed.



### Vertical position

It also features a second position which facilitates vertical tip access.



### Keep your workspace clean

The locking mechanism on the brushes makes them **fast and easy to replace**. The solder collector tray can be **easily emptied**.



### Brushes

**CL2008 / CL2007**  
**Fiber Brushes**  
provide a **soft cleaning**, especially recommended for regular usage to improve tip life. Supplied with CLMUP.



**CL1008 / CL1007**  
**Metal Brushes**  
provide a **thorough cleaning to recover the tip**, increasing heat transfer. Supplied with CLMU.





Our Cartridge Range is steadily growing as we are determined to respond to our clients' specific needs, cooperating closely with them to create **the right solution.**





**C115 Cartridge Range**  
for **NT115, AN115** and **NP115** Nano Tools

Ref.	Description	Image and dimensions	Suggested components	Compatible with
<b>C115116</b>	Chisel Cartridge 0.2 x 0.1 mm 0.008 x 0.004 in		Package 01005, 0201 Very fine pitch 0.4 mm QFP, IC	Stations: NASE, NANE, CDN Tools: NT115, AN115, NP115
<b>C115117</b>	Chisel Cartridge 0.4 x 0.2 mm 0.016 x 0.008 in		Package 0402 Very fine pitch 0.65 mm QFP, IC	Stations: NASE, NANE, CDN Tools: NT115, AN115, NP115
<b>C115108</b>	Chisel Cartridge 0.6 x 0.3 mm 0.024 x 0.012 in		Package 0603 PLCC, SO, SOT	Stations: NASE, NANE, CDN Tools: NT115, AN115, NP115
<b>C115125</b>	Chisel Cartridge 1 x 0.2 mm 0.039 x 0.008 in		Package 0805 Difficult to reach	Stations: NASE, NANE, CDN Tools: NT115, AN115, NP115
<b>C115113</b>	Chisel Cartridge 1 x 0.3 mm 0.039 x 0.012 in		Package 0805 Through-hole	Stations: NASE, NANE, CDN Tools: NT115, AN115, NP115
<b>C115213</b>	Chisel Cartridge 1 x 0.3 S1 mm 0.039 x 0.012 in		Package 0805 Through-hole High-thermal performance	Stations: NASE, NANE, CDN Tools: NT115, AN115, NP115
<b>C115221</b>	Chisel Cartridge 1.3 x 0.3 mm 0.051 x 0.012 in		Package 0805 Through-hole High-thermal performance	Stations: NASE, NANE, CDN Tools: NT115, AN115, NP115
<b>C115222</b>	Chisel Cartridge 1.6 x 0.3 mm 0.063 x 0.012 in		Package 0805 Through-hole High-thermal performance	Stations: NASE, NANE, CDN Tools: NT115, AN115, NP115



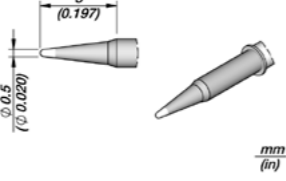
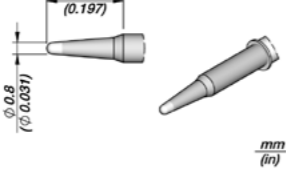

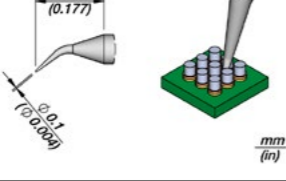
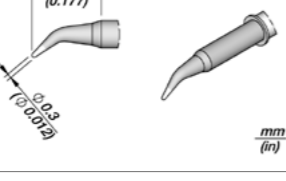
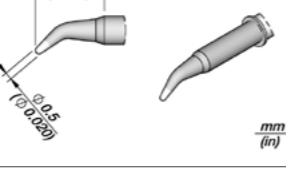

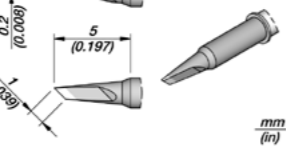
**C115 Cartridge Range** for **NT115, AN115** and **NP115** Nano Tools

Ref.	Description	Image and dimensions	Suggested components	Compatible with
<b>C115114</b>	Chisel Cartridge 1.8 x 0.5 mm 0.071 x 0.020 in		Package 0805 Through-hole	Stations: NASE, NANE, CDN Tools: NT115, AN115, NP115
<b>C115214</b>	Chisel Cartridge 1.8 x 0.5 mm S1 0.071 x 0.020 in		Package 1206, 1210 Through-hole High-thermal performance	Stations: NASE, NANE, CDN Tools: NT115, AN115, NP115
<b>C115223</b>	Chisel Cartridge 2.4 x 0.6 mm 0.094 x 0.024 in		Package 0805 Through-hole High-thermal performance	Stations: NASE, NANE, CDN Tools: NT115, AN115, NP115
<b>C115109</b>	Bevel Cartridge Ø 0.6 mm Ø 0.024 in		Drag soldering SMD Through-hole	Stations: NASE, NANE, CDN Tools: NT115, AN115, NP115
<b>C115127</b>	Bevel Cartridge Ø 1 mm Ø 0.039 in		Drag soldering SMD Through-hole	Stations: NASE, NANE, CDN Tools: NT115, AN115, NP115
<b>C115128</b>	Spoon Cartridge Ø 1 mm Ø 0.039 in		Drag soldering SMD Through-hole	Stations: NASE, NANE, CDN Tools: NT115, AN115, NP115
<b>C115126</b>	Conical Cartridge Ø 0.1 mm S1 Ø 0.004 in		Package 01005 Very fine pitch 0.4 mm QFP, IC	Stations: NASE, NANE, CDN Tools: NT115, AN115, NP115
<b>C115101</b>	Conical Cartridge Ø 0.1 mm Ø 0.004 in		Package 01005 Very fine pitch 0.4 mm QFP, IC	Stations: NASE, NANE, CDN Tools: NT115, AN115, NP115

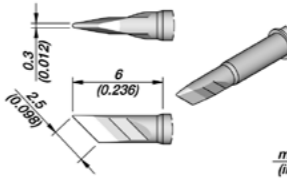
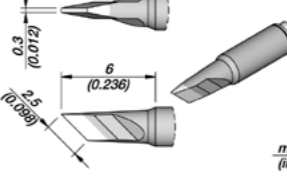
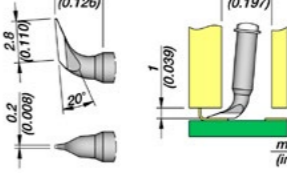
**C115 Cartridge Range for NT115, AN115 and NP115 Nano Tools**

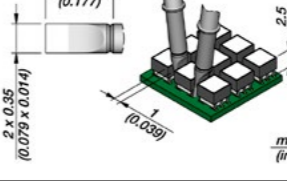
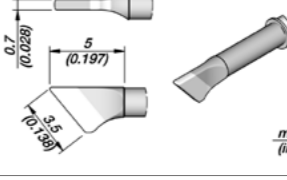
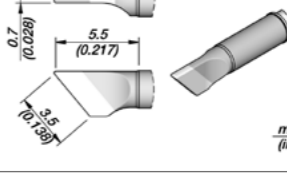
	Ref.	Description	Image and dimensions	Suggested components	Compatible with
	<b>C115103</b>	Conical Cartridge Ø 0.3 mm S1 Ø 0.012 in		Package 0201, 0402 Very fine pitch 0.65 mm QFP, IC	Stations: NASE, NANE, CDN Tools: NT115, AN115, NP115
	<b>C115106</b>	Conical Cartridge Ø 0.5 mm Ø 0.020 in		Package 0603 QFP, IC	Stations: NASE, NANE, CDN Tools: NT115, AN115, NP115
	<b>C115107</b>	Conical Cartridge Ø 0.8 mm Ø 0.031 in		General use	Stations: NASE, NANE, CDN Tools: NT115, AN115, NP115
	<b>C115124</b>	Conical Bent Cartridge Ø 0.1 mm S1 Ø 0.004 in		Package 01005 Very fine pitch 0.4 mm QFP, IC	Stations: NASE, NANE, CDN Tools: NT115, AN115, NP115
	<b>C115118</b>	Conical Bent Cartridge Ø 0.1 mm Ø 0.004 in		Package 01005 Very fine pitch 0.4 mm QFP, IC	Stations: NASE, NANE, CDN Tools: NT115, AN115, NP115
	<b>C115105</b>	Conical Bent Cartridge Ø 0.3 mm Ø 0.012 in		Package 0201, 0402 Fine pitch 0.65 mm QFP, IC	Stations: NASE, NANE, CDN Tools: NT115, AN115, NP115
	<b>C115110</b>	Conical Bent Cartridge Ø 0.5 mm Ø 0.020 in		Package 0603 QFP, IC	Stations: NASE, NANE, CDN Tools: NT115, AN115, NP115
	<b>C115120</b>	Knife Cartridge 1 x 0.2 mm 0.039 x 0.008 in		Drag soldering SMD Package 0805 Through-hole	Stations: NASE, NANE, CDN Tools: NT115, AN115, NP115

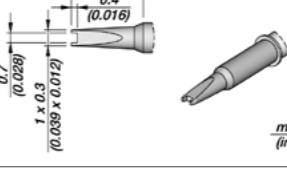
**C115 Cartridge Range for NT115, AN115 and NP115 Nano Tools**

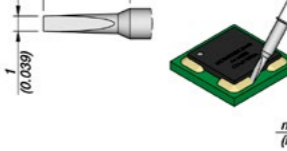
	Ref.	Description	Image and dimensions	Suggested components	Compatible with
	<b>C115112</b>	Knife Cartridge 2.5 x 0.3 mm 0.098 x 0.012 in		Drag soldering SMD SO, SOT Package 1210, 1812, 2010, 2512	Stations: NASE, NANE, CDN Tools: NT115, AN115, NP115
	<b>C115212</b>	Knife Cartridge 2.5 x 0.3 mm S1 0.098 x 0.012 in		Drag soldering SMD SO, SOT Package 1210, 1812, 2010, 2512 High-thermal performance	Stations: NASE, NANE, CDN Tools: NT115, AN115, NP115
	<b>C115129</b>	Knife Cartridge 2.8 x 0.2 mm 0.110 x 0.008 in		IC, Difficult to reach	Stations: NASE, NANE, CDN Tools: NT115, AN115, NP115
	<b>C115131</b>	Blade Cartridge 2 x 0.35 mm 0.079 x 0.014 in		LED SMD 2727, 1921, 1415	Stations: NASE, NANE, CDN Tools: NT115, AN115, NP115
	<b>C115111</b>	Blade Cartridge 3.5 x 0.7 mm 0.138 x 0.028 in		Package 1210, 1812 SO, SOT	Stations: NASE, NANE, CDN Tools: NT115, AN115, NP115
	<b>C115211</b>	Blade Cartridge 3.5 x 0.7 mm S1 0.138 x 0.028 in		Package 1210, 1812 SO, SOT High-thermal performance	Stations: NASE, NANE, CDN Tools: NT115, AN115, NP115
	<b>C115132</b>	Chip Components Cartridge 0.7 mm 0.028 in		Package 0201	Stations: NASE, NANE, CDN Tools: NT115, AN115, NP115
	<b>C115115</b>	Conformal Coating Removal Steel Cartridge 1 mm 0.039 in		Stainless Steel Remove underfill encapsulants	Stations: NASE, NANE, CDN Tools: NT115, AN115, NP115





**C120 Cartridge Range**  
for PA120 and AM120 Micro Tweezers



	Ref.	Description	Image and dimensions	Suggested components	Compatible with	
	<b>C120001</b>	Conical Bent Cartridge Ø 0.2 mm Ø 0.008 in		Package 0201, 0402	Stations: CP, DI, DDE, DME Tools: AM120, PA120	
	<b>C120002</b>	Conical Bent Cartridge Ø 0.2 mm Ø 0.008 in		Package 0201, 0402	Stations: CP, DI, DDE, DME Tools: AM120, PA120	
	<b>C120902</b>	Conical Bent Cartridge Ø 0.3 mm Ø 0.012 in		Package 0201, 0402 Fine pitch 0.65 mm QFP, IC	Stations: CP, DI, DDE, DME Tools: AM120, PA120	
	<b>C120006</b>	Conical Bent Cartridge Ø 0.5 mm Ø 0.020 in		Package 0603 QFP, IC	Stations: CP, DI, DDE, DME Tools: AM120, PA120	
	<b>C120004</b>	Conical Bent Cartridge Ø 0.7 mm S1 Ø 0.028 in		SMD capacitors QFP, IC Through-hole	Stations: CP, DI, DDE, DME Tools: AM120, PA120	
	<b>C120012</b>	Conical Bent Cartridge Ø 0.7 mm S2 Ø 0.028 in		SMD capacitors QFP, IC Through-hole Tip with an extra tinned surface	Stations: CP, DI, DDE, DME Tools: AM120, PA120	
		<b>C120011</b>	Chisel Bent Cartridge 0.6 x 0.3 mm 0.024 x 0.012 in		Package 0603	Stations: CP, DI, DDE, DME Tools: AM120, PA120

**C120 Cartridge Range for PA120 and AM120 Micro Tweezers**



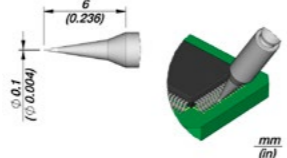
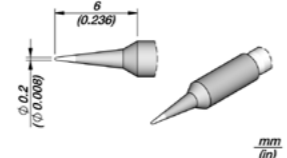
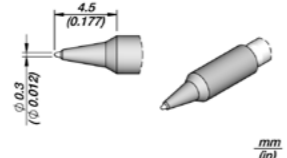
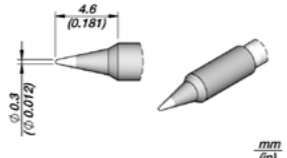
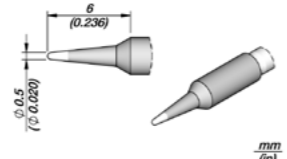
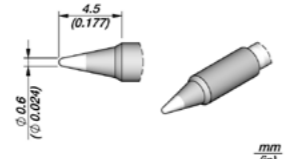
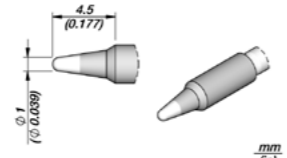

	Ref.	Description	Image and dimensions	Suggested components	Compatible with
	<b>C120013</b>	Blade Cartridge 2 mm 0.079 in		LED SMD 2727, 1921, 1415	Stations: CP, DI, DDE, DME Tools: AM120, PA120
	<b>C120003</b>	Blade Cartridge 3 mm 0.118 in		Package 1210, 1812 SO, SOT	Stations: CP, DI, DDE, DME Tools: AM120, PA120
	<b>C120007</b>	Blade Cartridge 3.5 mm Right 0.138 in		Package 1210, 1812 SO, SOT	Stations: CP, DI, DDE, DME Tools: AM120, PA120
	<b>C120008</b>	Blade Cartridge 3.5 mm Left 0.138 in		Package 1210, 1812 SO, SOT	Stations: CP, DI, DDE, DME Tools: AM120, PA120
	<b>C120005</b>	Blade Cartridge 5 mm 0.197 in		SO, SOT	Stations: CP, DI, DDE, DME Tools: AM120, PA120
	<b>C120009</b>	Blade Cartridge 6 mm Right 0.236 in		SO, SOT	Stations: CP, DI, DDE, DME Tools: AM120, PA120
	<b>C120010</b>	Blade Cartridge 6 mm Left 0.236 in		SO, SOT	Stations: CP, DI, DDE, DME Tools: AM120, PA120

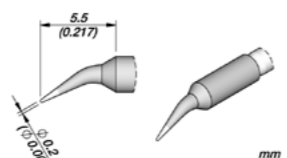

**C210 Cartridge Range**  
for T210, B-100 and B-500 Handles

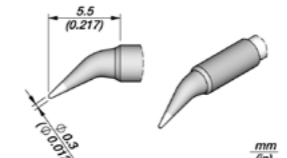
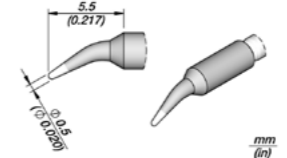
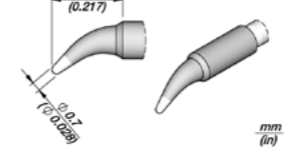
	Ref.	Description	Image and dimensions	Suggested components	Compatible with
	<b>C210020</b>	Conical Cartridge Ø 0.1 mm Ø 0.004 in		Package 01005, 0201 Very fine pitch 0.4 mm QFP, IC	Stations: CDS, DI, DDE, DME, B-IRON 100 / 500 Tools: T210, T210P, T210N, B-100, B-500
	<b>C210009</b>	Conical Cartridge Ø 0.2 mm Ø 0.008 in		Package 01005, 0201 Very fine pitch 0.4mm QFP, IC	Stations: CDS, DI, DDE, DME, B-IRON 100 / 500 Tools: T210, T210P, T210N, B-100, B-500
	<b>C210016</b>	Conical Cartridge Ø 0.3 mm S1 Ø 0.012 in		Package 0201, 0402 Fine pitch 0.65 mm QFP, IC	Stations: CDS, DI, DDE, DME, B-IRON 100 / 500 Tools: T210, T210P, T210N, B-100, B-500
	<b>C210001</b>	Conical Cartridge Ø 0.3 mm S2 Ø 0.012 in		Package 0201, 0402 Fine pitch 0.65 mm QFP, IC	Stations: CDS, DI, DDE, DME, B-IRON 100 / 500 Tools: T210, T210P, T210N, B-100, B-500
	<b>C210013</b>	Conical Cartridge Ø 0.5 mm Ø 0.020 in		Package 0603 QFP, IC	Stations: CDS, DI, DDE, DME, B-IRON 100 / 500 Tools: T210, T210P, T210N, B-100, B-500
	<b>C210003</b>	Conical Cartridge Ø 0.6 mm Ø 0.024 in		General use	Stations: CDS, DI, DDE, DME, B-IRON 100 / 500 Tools: T210, T210P, T210N, B-100, B-500
	<b>C210005</b>	Conical Cartridge Ø 1 mm Ø 0.039 in		General use	Stations: CDS, DI, DDE, DME, B-IRON 100 / 500 Tools: T210, T210P, T210N, B-100, B-500
	<b>C210002</b>	Conical Bent Cartridge Ø 0.2 mm Ø 0.008 in		Package 0201, 0402	Stations: CDS, DI, DDE, DME, B-IRON 100 / 500 Tools: T210, T210P, T210N, B-100, B-500

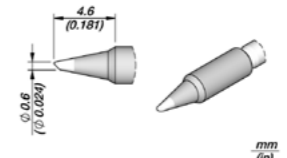
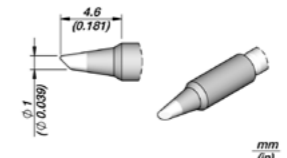
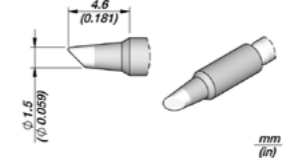
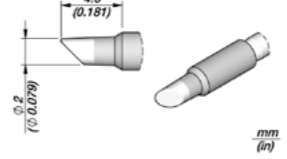
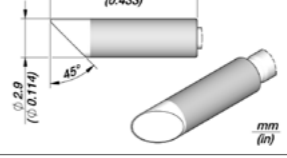
**C210 Cartridge Range for T210, B-100 and B-500 Handles**

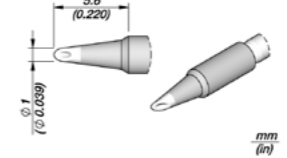
	Ref.	Description	Image and dimensions	Suggested components	Compatible with
	<b>C210010</b>	Conical Bent Cartridge Ø 0.3 mm Ø 0.012 in		Package 0201, 0402 Fine pitch 0.65 mm QFP, IC	Stations: CDS, DI, DDE, DME, B-IRON 100 / 500 Tools: T210, T210P, T210N, B-100, B-500
	<b>C210014</b>	Conical Bent Cartridge Ø 0.5 mm Ø 0.020 in		Package 0603 QFP, IC	Stations: CDS, DI, DDE, DME, B-IRON 100 / 500 Tools: T210, T210P, T210N, B-100, B-500
	<b>C210004</b>	Conical Bent Cartridge Ø 0.7 mm Ø 0.028 in		General use	Stations: CDS, DI, DDE, DME, B-IRON 100 / 500 Tools: T210, T210P, T210N, B-100, B-500
	<b>C210036</b>	Bevel Cartridge Ø 0.6 mm Ø 0.024 in		Drag Soldering General use	Stations: CDS, DI, DDE, DME, B-IRON 100 / 500 Tools: T210, T210P, T210N, B-100, B-500
	<b>C210006</b>	Bevel Cartridge Ø 1 mm Ø 0.039 in		Drag Soldering General use	Stations: CDS, DI, DDE, DME, B-IRON 100 / 500 Tools: T210, T210P, T210N, B-100, B-500
	<b>C210027</b>	Bevel Cartridge Ø 1.5 mm Ø 0.059 in		Drag Soldering General use	Stations: CDS, DI, DDE, DME, B-IRON 100 / 500 Tools: T210, T210P, T210N, B-100, B-500
	<b>C210031</b>	Bevel Cartridge Ø 2 mm Ø 0.079 in		Drag Soldering General use	Stations: CDS, DI, DDE, DME, B-IRON 100 / 500 Tools: T210, T210P, T210N, B-100, B-500
	<b>C210040</b>	Bevel Cartridge Ø 2.9 mm Ø 0.114 in		Drag Soldering General use	Stations: CDS, DI, DDE, DME, B-IRON 100 / 500 Tools: T210, T210P, T210N, B-100, B-500
	<b>C210028</b>	Spoon Cartridge Ø 1 mm Ø 0.039 in		Drag soldering	Stations: CDS, DI, DDE, DME, B-IRON 100 / 500 Tools: T210, T210P, T210N, B-100, B-500

**C210 Cartridge Range for T210, B-100 and B-500 Handles**

Ref.	Description	Image and dimensions	Suggested components	Compatible with
<b>C210029</b>	Spoon Cartridge Ø 1.5 mm Ø 0.059 in		Drag soldering	Stations: CDS, DI, DDE, DME, B-IRON 100 / 500 Tools: T210, T210P, T210N, B-100, B-500
<b>C210030</b>	Spoon Cartridge Ø 2 mm Ø 0.079 in		Drag soldering	Stations: CDS, DI, DDE, DME, B-IRON 100 / 500 Tools: T210, T210P, T210N, B-100, B-500
<b>C210038</b>	Barrel Cartridge Ø 8 mm Ø 0.031 in		Through-hole Cable soldering / desoldering	Stations: CDS, DI, DDE, DME, B-IRON 100 / 500 Tools: T210, T210P, T210N, B-100, B-500
<b>C210019</b>	Chisel Cartridge 0.2 x 0.1 mm 0.008 x 0.004 in		Package 01005, 0201 Very fine pitch 0.4 mm QFP, IC	Stations: CDS, DI, DDE, DME, B-IRON 100 / 500 Tools: T210, T210P, T210N, B-100, B-500
<b>C210023</b>	Chisel Cartridge 0.4 x 0.2 mm 0.016 x 0.008 in		Package 0402 Very fine pitch 0.65 mm QFP, IC	Stations: CDS, DI, DDE, DME, B-IRON 100 / 500 Tools: T210, T210P, T210N, B-100, B-500
<b>C210021</b>	Chisel Cartridge 0.6 x 0.3 mm 0.024 x 0.012 in		Package 0603	Stations: CDS, DI, DDE, DME, B-IRON 100 / 500 Tools: T210, T210P, T210N, B-100, B-500
<b>C210024</b>	Chisel Cartridge 0.8 x 0.3 mm 0.032 x 0.012 in		Package 0805 Through-hole	Stations: CDS, DI, DDE, DME, B-IRON 100 / 500 Tools: T210, T210P, T210N, B-100, B-500
<b>C210022</b>	Chisel Cartridge 1.3 x 0.4 mm 0.051 x 0.016 in		Package 0805 Through-hole	Stations: CDS, DI, DDE, DME, B-IRON 100 / 500 Tools: T210, T210P, T210N, B-100, B-500
<b>C210008</b>	Chisel Cartridge 1.3 x 0.6 mm 0.051 x 0.024 in		Package 0805 Through-hole	Stations: CDS, DI, DDE, DME, B-IRON 100 / 500 Tools: T210, T210P, T210N, B-100, B-500

**C210 Cartridge Range for T210, B-100 and B-500 Handles**

Ref.	Description	Image and dimensions	Suggested components	Compatible with
<b>C210007</b>	Chisel Cartridge 2.3 x 0.7 mm 0.091 x 0.028 in		Package 0805 Through-hole	Stations: CDS, DI, DDE, DME, B-IRON 100 / 500 Tools: T210, T210P, T210N, B-100, B-500
<b>C210039</b>	Chisel Cartridge 2.9 x 0.7 mm 0.114 x 0.028 in		Package 0805 Through-hole	Stations: CDS, DI, DDE, DME, B-IRON 100 / 500 Tools: T210, T210P, T210N, B-100, B-500
<b>C210017</b>	Pin / Connector Cartridge Ø 0.7 mm Ø 0.028 in		Through-hole	Stations: CDS, DI, DDE, DME, B-IRON 100 / 500 Tools: T210, T210P, T210N, B-100, B-500
<b>C210015</b>	Pin / Connector Cartridge Ø 0.8 mm Ø 0.032 in		Through-hole Coaxial connector	Stations: CDS, DI, DDE, DME, B-IRON 100 / 500 Tools: T210, T210P, T210N, B-100, B-500
<b>C210025</b>	Pin / Connector Cartridge Ø 1.1 mm Ø 0.043 in		Through-hole Coaxial connector	Stations: CDS, DI, DDE, DME, B-IRON 100 / 500 Tools: T210, T210P, T210N, B-100, B-500
<b>C210012</b>	Pin / Connector Cartridge Ø 1 mm Ø 0.039 in		Cables Connectors	Stations: CDS, DI, DDE, DME, B-IRON 100 / 500 Tools: T210, T210P, T210N, B-100, B-500
<b>C210033</b>	Knife Cartridge 2.5 x 0.3 mm 0.098 x 0.012 in		Drag soldering SMD SO, SOT Package 1210, 1812, 2010, 2512	Stations: CDS, DI, DDE, DME, B-IRON 100 / 500 Tools: T210, T210P, T210N, B-100, B-500
<b>C210018</b>	Knife Cartridge 3.4 x 0.3 mm 0.134 x 0.012 in		Drag soldering SMD SO, SOT Package 1210, 1812, 2010, 2512	Stations: CDS, DI, DDE, DME, B-IRON 100 / 500 Tools: T210, T210P, T210N, B-100, B-500
<b>C210034</b>	Conformal Coating Removal Steel Cartridge 1 x 0.1 mm 0.039 x 0.004 in		Stainless Steel Remove underfill encapsulants	Stations: CDS, DI, DDE, DME, B-IRON 100 / 500 Tools: T210, T210P, T210N, B-100, B-500



**C245 Cartridge Range**  
for T245 General Purpose Handles

Ref.	Description	Image and dimensions	Suggested components	Compatible with
<b>C245030</b>	Conical Cartridge Ø 0.3 mm Ø 0.012 in		Package 0201, 0402 Fine pitch 0.65 mm QFP, IC	Stations: CDB, CDEB, DI, DDE, DME Tools: T245, T245G, T245P, T245N
<b>C245032</b>	Conical Cartridge Ø 0.4 mm Ø 0.016 in		Package 0201, 0402 Fine pitch 0.65 mm QFP, IC	Stations: CDB, CDEB, DI, DDE, DME Tools: T245, T245G, T245P, T245N
<b>C245036</b>	Conical Cartridge Ø 0.5 mm S1 Ø 0.020 in		Package 0603 QFP, IC	Stations: CDB, CDEB, DI, DDE, DME Tools: T245, T245G, T245P, T245N
<b>C245930</b>	Conical Cartridge Ø 0.5 mm S2 Ø 0.020 in		Package 0603 QFP, IC	Stations: CDB, CDEB, DI, DDE, DME Tools: T245, T245G, T245P, T245N
<b>C245001</b>	Conical Cartridge Ø 0.6 mm Ø 0.024 in		Package 0603 QFP, IC	Stations: CDB, CDEB, DI, DDE, DME Tools: T245, T245G, T245P, T245N
<b>C245937</b>	Conical Cartridge Ø 0.6 mm HT Ø 0.024 in		Package 0603 QFP, IC	Stations: CDB, CDEB, DI, DDE, DME Tools: T245, T245G, T245P, T245N
<b>C245957</b>	Conical Cartridge Ø 0.8 mm Ø 0.031 in		Through-hole	Stations: CDB, CDEB, DI, DDE, DME Tools: T245, T245G, T245P, T245N

**C245 Cartridge Range** for T245 General Purpose Handles

Ref.	Description	Image and dimensions	Suggested components	Compatible with
<b>C245903</b>	Conical Cartridge Ø 1 mm S1 Ø 0.040 in		General use	Stations: CDB, CDEB, DI, DDE, DME Tools: T245, T245G, T245P, T245N
<b>C245041</b>	Conical Cartridge Ø 1 mm S2 Ø 0.040 in		General use Tip with an extra tinned surface	Stations: CDB, CDEB, DI, DDE, DME Tools: T245, T245G, T245P, T245N
<b>C245403</b>	Conical Cartridge Ø 1 HT mm Ø 0.040 in		General use	Stations: CDB, CDEB, DI, DDE, DME Tools: T245, T245G, T245P, T245N
<b>C245943</b>	Conical Cartridge Ø 1.7 mm Ø 0.070 in		General use	Stations: CDB, CDEB, DI, DDE, DME Tools: T245, T245G, T245P, T245N
<b>C245933</b>	Conical Cartridge Ø 2.2 mm Ø 0.090 in		General use	Stations: CDB, CDEB, DI, DDE, DME Tools: T245, T245G, T245P, T245N
<b>C245107</b>	Conical Cartridge Ø 3 mm HT Ø 0.118 in		General use	Stations: CDB, CDEB, DI, DDE, DME Tools: T245, T245G, T245P, T245N
<b>C245034</b>	Conical Bent Cartridge Ø 0.4 mm S1 Ø 0.016 in		Package 0201, 0402 Fine pitch 0.65 mm QFP, IC	Stations: CDB, CDEB, DI, DDE, DME Tools: T245, T245G, T245P, T245N
<b>C245029</b>	Conical Bent Cartridge Ø 0.4 mm S2 Ø 0.016 in		Package 0201, 0402 Fine pitch 0.65 mm QFP, IC	Stations: CDB, CDEB, DI, DDE, DME Tools: T245, T245G, T245P, T245N

**C245 Cartridge Range for T245 General Purpose Handles**

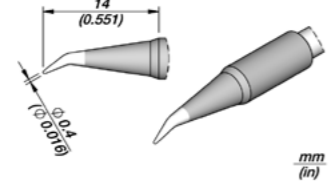
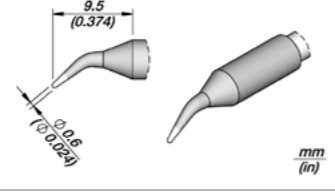
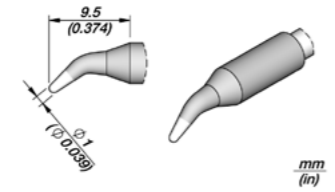
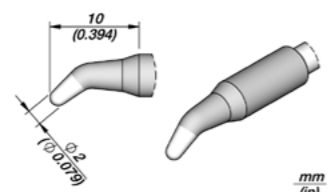
	Ref.	Description	Image and dimensions	Suggested components	Compatible with
	<b>C245126</b>	Conical Bent Cartridge Ø 0.4 mm S3 Ø 0.016 in		Package 0201, 0402 Fine pitch 0.65 mm QFP, IC	Stations: CDB, CDEB, DI, DDE, DME Tools: T245, T245G, T245P, T245N
	<b>C245786</b>	Conical Bent Cartridge Ø 0.4 mm S4 Ø 0.016 in		Package 0201, 0402 Fine pitch 0.65 mm QFP, IC	Stations: CDB, CDEB, DI, DDE, DME Tools: T245, T245G, T245P, T245N
	<b>C245929</b>	Conical Bent Cartridge Ø 0.6 mm Ø 0.024 in		Package 0603 QFP, IC	Stations: CDB, CDEB, DI, DDE, DME Tools: T245, T245G, T245P, T245N
	<b>C245935</b>	Conical Bent Cartridge Ø 0.8 mm Ø 0.031 in		Through-hole	Stations: CDB, CDEB, DI, DDE, DME Tools: T245, T245G, T245P, T245N
	<b>C245904</b>	Conical Bent Cartridge Ø 1 mm Ø 0.039 in		General use	Stations: CDB, CDEB, DI, DDE, DME Tools: T245, T245G, T245P, T245N
	<b>C245259</b>	Conical Bent Cartridge Ø 1.5 mm Ø 0.059 in		General use	Stations: CDB, CDEB, DI, DDE, DME Tools: T245, T245G, T245P, T245N
	<b>C245260</b>	Conical Bent Cartridge Ø 2 mm HT Ø 0.079 in		General use	Stations: CDB, CDEB, DI, DDE, DME Tools: T245, T245G, T245P, T245N
	<b>C245627</b>	Conical Bent Cartridge Ø 3 mm Ø 0.118 in		General use	Stations: CDB, CDEB, DI, DDE, DME Tools: T245, T245G, T245P, T245N

**C245 Cartridge Range for T245 General Purpose Handles**

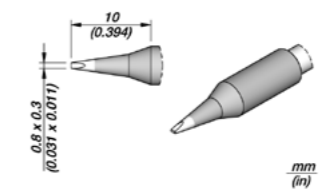
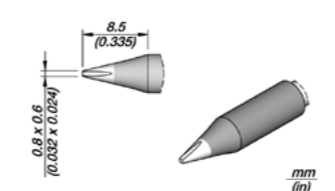
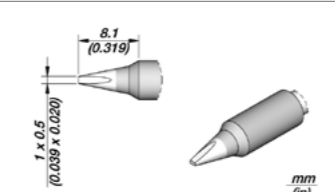
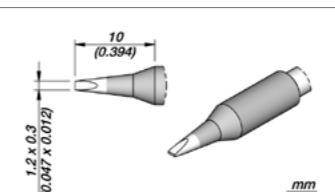
	Ref.	Description	Image and dimensions	Suggested components	Compatible with
	<b>C245628</b>	Conical Bent Cartridge Ø 4 mm HT Ø 0.157 in		General use	Stations: CDB, CDEB, DI, DDE, DME Tools: T245, T245G, T245P, T245N
	<b>C245731</b>	Chisel Cartridge 0.6 x 0.3 mm 0.024 x 0.011 in		Package 0603	Stations: CDB, CDEB, DI, DDE, DME Tools: T245, T245G, T245P, T245N
	<b>C245773</b>	Chisel Cartridge 0.8 x 0.3 mm 0.031 x 0.011 in		Package 0805 Through-hole	Stations: CDB, CDEB, DI, DDE, DME Tools: T245, T245G, T245P, T245N
	<b>C245742</b>	Chisel Cartridge 0.8 x 0.6 mm HT 0.032 x 0.024 in		Package 0805 Through-hole	Stations: CDB, CDEB, DI, DDE, DME Tools: T245, T245G, T245P, T245N
	<b>C245170</b>	Chisel Cartridge 1 x 0.5 mm 0.039 x 0.020 in		General use	Stations: CDB, CDEB, DI, DDE, DME Tools: T245, T245G, T245P, T245N
	<b>C245774</b>	Chisel Cartridge 1.2 x 0.3 mm 0.047 x 0.012 in		General use	Stations: CDB, CDEB, DI, DDE, DME Tools: T245, T245G, T245P, T245N
	<b>C245906</b>	Chisel Cartridge 1.2 x 0.7 mm 0.047 x 0.027 in		General use	Stations: CDB, CDEB, DI, DDE, DME Tools: T245, T245G, T245P, T245N
	<b>C245406</b>	Chisel Cartridge 1.2 x 0.7 mm HT 0.047 x 0.028 in		General use	Stations: CDB, CDEB, DI, DDE, DME Tools: T245, T245G, T245P, T245N



**C245 Cartridge Range for T245 General Purpose Handles**

Ref.	Description	Image and dimensions	Suggested components	Compatible with
<b>C245768</b>	Chisel Cartridge 1.5 x 0.3 mm 0.059 x 0.012 in		General use	Stations: CDB, CDEB, DI, DDE, DME Tools: T245, T245G, T245P, T245N
<b>C245171</b>	Chisel Cartridge 1.8 x 0.5 mm 0.071 x 0.020 in		General use	Stations: CDB, CDEB, DI, DDE, DME Tools: T245, T245G, T245P, T245N
<b>C245944</b>	Chisel Cartridge 1.8 x 0.8 mm 0.070 x 0.031 in		General use	Stations: CDB, CDEB, DI, DDE, DME Tools: T245, T245G, T245P, T245N
<b>C245907</b>	Chisel Cartridge 2.2 x 1 mm 0.087 x 0.039 in		General use	Stations: CDB, CDEB, DI, DDE, DME Tools: T245, T245G, T245P, T245N
<b>C245407</b>	Chisel Cartridge 2.2 x 1 mm HT 0.087 x 0.039 in		General use	Stations: CDB, CDEB, DI, DDE, DME Tools: T245, T245G, T245P, T245N
<b>C245770</b>	Chisel Cartridge 2.4 x 0.3 mm 0.094 x 0.012 in		General use	Stations: CDB, CDEB, DI, DDE, DME Tools: T245, T245G, T245P, T245N
<b>C245759</b>	Chisel Cartridge 2.4 x 0.5 mm HT 0.094 x 0.019 in		General use	Stations: CDB, CDEB, DI, DDE, DME Tools: T245, T245G, T245P, T245N
<b>C245741</b>	Chisel Cartridge 2.4 x 0.6 mm HT 0.095 x 0.024 in		General use	Stations: CDB, CDEB, DI, DDE, DME Tools: T245, T245G, T245P, T245N

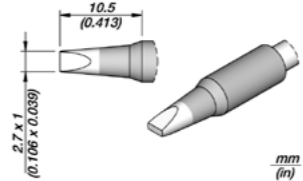
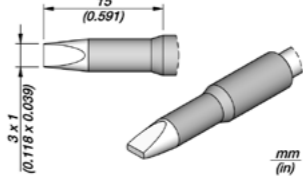
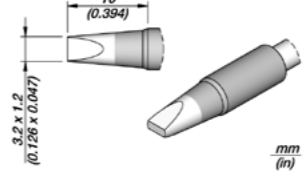
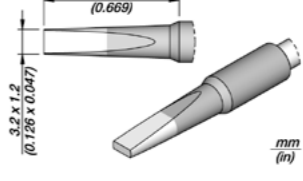
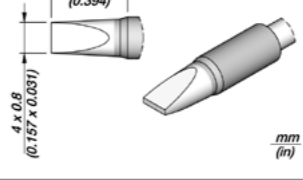
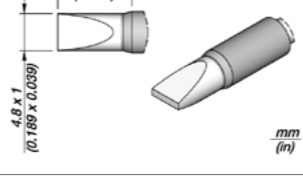
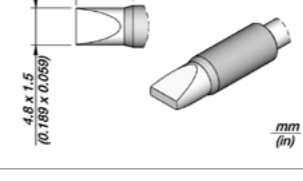
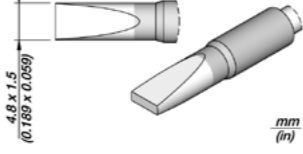
**C245 Cartridge Range for T245 General Purpose Handles**

Ref.	Description	Image and dimensions	Suggested components	Compatible with
<b>C245729</b>	Chisel Cartridge 2.7 x 1 mm 0.106 x 0.039 in		General use	Stations: CDB, CDEB, DI, DDE, DME Tools: T245, T245G, T245P, T245N
<b>C245061</b>	Chisel Cartridge 3 x 1 mm 0.118 x 0.039 in		General use	Stations: CDB, CDEB, DI, DDE, DME Tools: T245, T245G, T245P, T245N
<b>C245911</b>	Chisel Cartridge 3.2 x 1.2 mm 0.126 x 0.047 in		General use	Stations: CDB, CDEB, DI, DDE, DME Tools: T245, T245G, T245P, T245N
<b>C245775</b>	Chisel Cartridge 3.2 x 1.2 mm S1 0.126 x 0.047 in		General use	Stations: CDB, CDEB, DI, DDE, DME Tools: T245, T245G, T245P, T245N
<b>C245755</b>	Chisel Cartridge 4 x 0.8 mm HT 0.157 x 0.031 in		General use	Stations: CDB, CDEB, DI, DDE, DME Tools: T245, T245G, T245P, T245N
<b>C245756</b>	Chisel Cartridge 4.8 x 1 mm HT 0.189 x 0.374 in		General use	Stations: CDB, CDEB, DI, DDE, DME Tools: T245, T245G, T245P, T245N
<b>C245908</b>	Chisel Cartridge 4.8 x 1.5 mm HT S1 0.189 x 0.059 in		General use	Stations: CDB, CDEB, DI, DDE, DME Tools: T245, T245G, T245P, T245N
<b>C245708</b>	Chisel Cartridge 4.8 x 1.5 mm HT S2 0.189 x 0.059 in		General use	Stations: CDB, CDEB, DI, DDE, DME Tools: T245, T245G, T245P, T245N

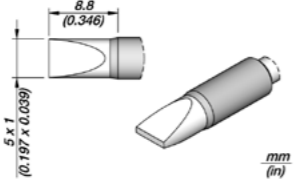
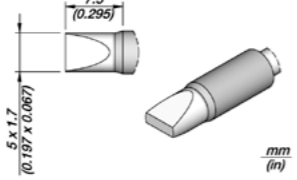
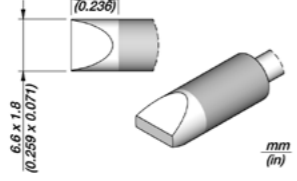

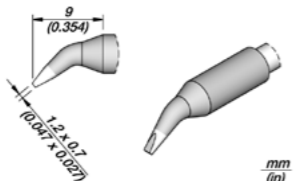
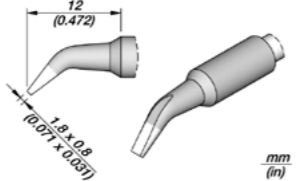
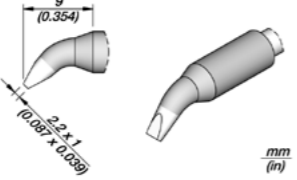
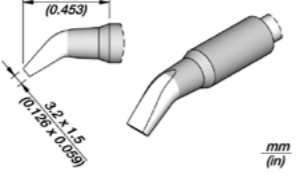
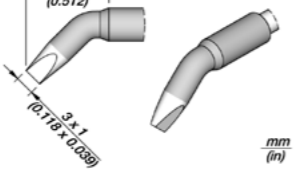
**C245 Cartridge Range for T245 General Purpose Handles**

	Ref.	Description	Image and dimensions	Suggested components	Compatible with
	<b>C245967</b>	Chisel Cartridge 5 x 1 mm HT 0.197 x 0.039 in		General use	Stations: CDB, CDEB, DI, DDE, DME Tools: T245, T245G, T245P, T245N
	<b>C245069</b>	Chisel Cartridge 5 x 1.7 mm HT 0.197 x 0.067 in		General use	Stations: CDB, CDEB, DI, DDE, DME Tools: T245, T245G, T245P, T245N
	<b>C245966</b>	Chisel Cartridge 6.6 x 1.8 mm HT 0.259 x 0.071 in		General use	Stations: CDB, CDEB, DI, DDE, DME Tools: T245, T245G, T245P, T245N
	<b>C245962</b>	Chisel Bent Cartridge 1.2 x 0.7 mm 0.047 x 0.027 in		General use	Stations: CDB, CDEB, DI, DDE, DME Tools: T245, T245G, T245P, T245N
	<b>C245963</b>	Chisel Bent Cartridge 1.8 x 0.8 mm 0.071 x 0.031 in		General use	Stations: CDB, CDEB, DI, DDE, DME Tools: T245, T245G, T245P, T245N
	<b>C245946</b>	Chisel Bent Cartridge 2.2 x 1 mm 0.087 x 0.039 in		General use	Stations: CDB, CDEB, DI, DDE, DME Tools: T245, T245G, T245P, T245N
	<b>C245732</b>	Chisel Bent Cartridge 3.2 x 1.5 mm 0.126 x 0.059 in		General use	Stations: CDB, CDEB, DI, DDE, DME Tools: T245, T245G, T245P, T245N
	<b>C245761</b>	Chisel Bent Cartridge 3 x 1 mm 0.118 x 0.039 in		General use	Stations: CDB, CDEB, DI, DDE, DME Tools: T245, T245G, T245P, T245N

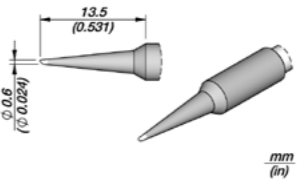
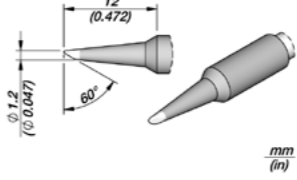
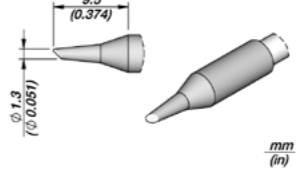
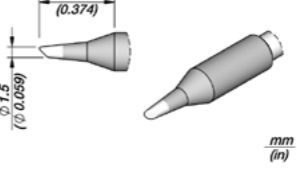
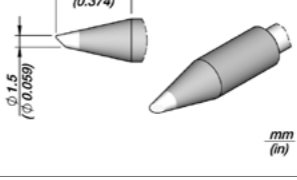
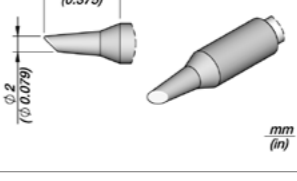
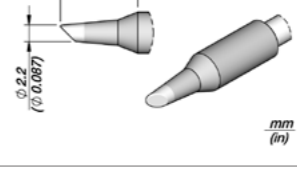
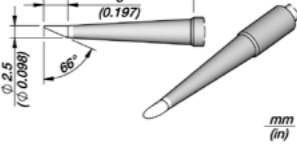

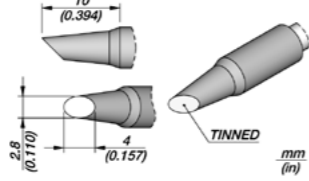
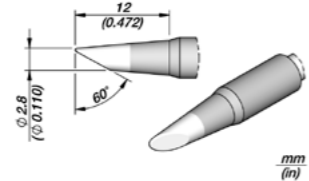
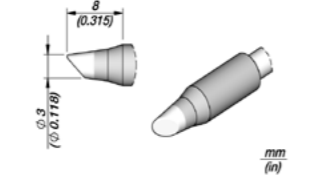
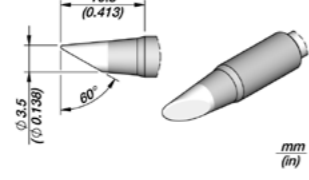
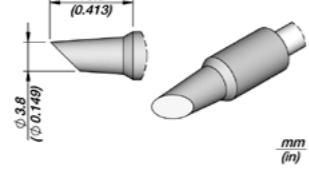
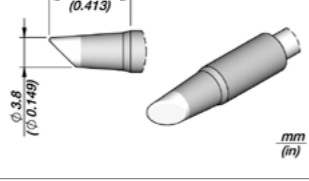
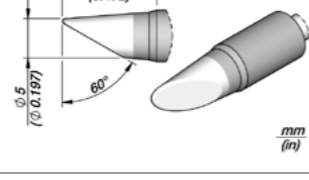

**C245 Cartridge Range for T245 General Purpose Handles**

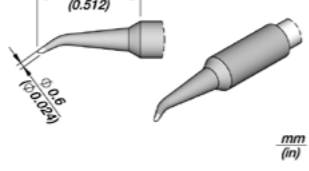
	Ref.	Description	Image and dimensions	Suggested components	Compatible with
	<b>C245747</b>	Bevel Cartridge Ø 0.6 mm Ø 0.024 in		Package 0603 Through-hole	Stations: CDB, CDEB, DI, DDE, DME Tools: T245, T245G, T245P, T245N
	<b>C245710</b>	Bevel Cartridge Ø 1.2 mm Ø 0.047 in		Drag soldering Through-hole	Stations: CDB, CDEB, DI, DDE, DME Tools: T245, T245G, T245P, T245N
	<b>C245064</b>	Bevel Cartridge Ø 1.3 mm Ø 0.051 in		Drag soldering Through-hole Hoof tip with reduced tinned surface, ideal for touch-up	Stations: CDB, CDEB, DI, DDE, DME Tools: T245, T245G, T245P, T245N
	<b>C245905</b>	Bevel Cartridge Ø 1.5 mm Ø 0.059 in		Drag soldering Through-hole	Stations: CDB, CDEB, DI, DDE, DME Tools: T245, T245G, T245P, T245N
	<b>C245405</b>	Bevel Cartridge Ø 1.5 mm HT Ø 0.059 in		Drag soldering Through-hole	Stations: CDB, CDEB, DI, DDE, DME Tools: T245, T245G, T245P, T245N
	<b>C245102</b>	Bevel Cartridge Ø 2 mm Ø 0.079 in		Drag soldering Through-hole Hoof tip with reduced tinned surface, ideal for touch-up	Stations: CDB, CDEB, DI, DDE, DME Tools: T245, T245G, T245P, T245N
	<b>C245945</b>	Bevel Cartridge Ø 2.2 mm Ø 0.087 in		Drag soldering Through-hole	Stations: CDB, CDEB, DI, DDE, DME Tools: T245, T245G, T245P, T245N
	<b>C245795</b>	Bevel Cartridge Ø 2.5 mm L Ø 0.098 in		Drag soldering Through-hole	Stations: CDB, CDEB, DI, DDE, DME Tools: T245, T245G, T245P, T245N

**C245 Cartridge Range for T245 General Purpose Handles**

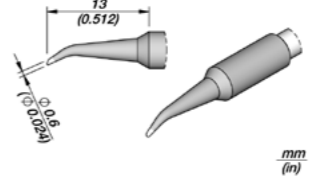

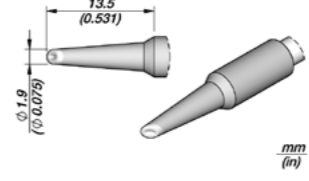
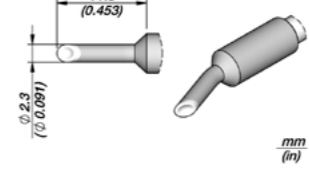
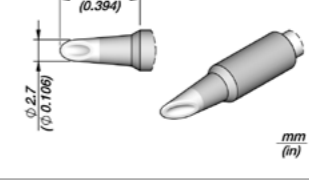
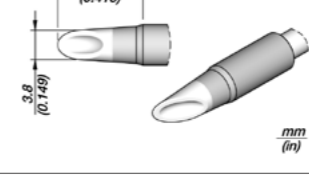

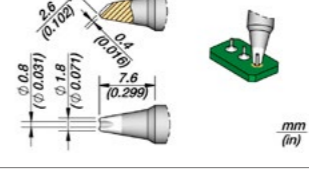
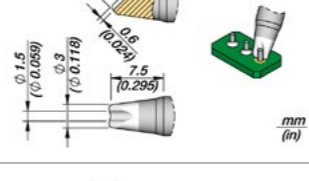
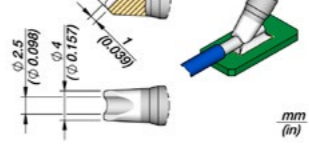
	Ref.	Description	Image and dimensions	Suggested components	Compatible with
	<b>C245784</b>	Bevel Cartridge Ø 2.8 mm Ø 0.110 in		Drag soldering Through-hole	Stations: CDB, CDEB, DI, DDE, DME Tools: T245, T245G, T245P, T245N
	<b>C245793</b>	Bevel Cartridge Ø 2.8 mm - 60° Ø 0.110 in - 60°		Drag soldering Through-hole	Stations: CDB, CDEB, DI, DDE, DME Tools: T245, T245G, T245P, T245N
	<b>C245912</b>	Bevel Cartridge Ø 3 mm Ø 0.118 in		Drag soldering Through-hole	Stations: CDB, CDEB, DI, DDE, DME Tools: T245, T245G, T245P, T245N
	<b>C245056</b>	Bevel Cartridge Ø 3.5 mm HT Ø 0.138 in		Drag soldering Through-hole	Stations: CDB, CDEB, DI, DDE, DME Tools: T245, T245G, T245P, T245N
	<b>C245797</b>	Bevel Cartridge Ø 3.8 mm Ø 0.149 in		Hoof Tip with reduced tinned surface, ideal for touch-up	Stations: CDB, CDEB, DI, DDE, DME Tools: T245, T245G, T245P, T245N
	<b>C245951</b>	Bevel Cartridge Ø 3.8 mm HT Ø 0.149 in		Drag soldering Through-hole	Stations: CDB, CDEB, DI, DDE, DME Tools: T245, T245G, T245P, T245N
	<b>C245766</b>	Bevel Cartridge Ø 5 mm Ø 0.197 in		Wide area	Stations: CDB, CDEB, DI, DDE, DME Tools: T245, T245G, T245P, T245N
	<b>C245748</b>	Bevel Bent Cartridge Ø 0.6 mm S1 Ø 0.024 in		Package 0603 Through-hole	Stations: CDB, CDEB, DI, DDE, DME Tools: T245, T245G, T245P, T245N

**C245 Cartridge Range for T245 General Purpose Handles**

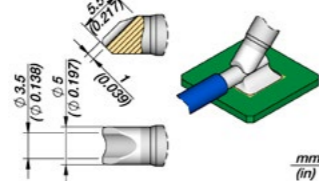

	Ref.	Description	Image and dimensions	Suggested components	Compatible with
	<b>C245749</b>	Bevel Bent Cartridge Ø 0.6 mm S2 Ø 0.024 in		Package 0603 Through-hole	Stations: CDB, CDEB, DI, DDE, DME Tools: T245, T245G, T245P, T245N
	<b>C245965</b>	Spoon Cartridge Ø 1.9 mm Ø 0.075 in		Drag soldering	Stations: CDB, CDEB, DI, DDE, DME Tools: T245, T245G, T245P, T245N
	<b>C245067</b>	Spoon Cartridge Ø 2.3 mm Ø 0.091 in		Drag soldering	Stations: CDB, CDEB, DI, DDE, DME Tools: T245, T245G, T245P, T245N
	<b>C245931</b>	Spoon Cartridge Ø 2.7 mm Ø 0.106 in		Drag soldering	Stations: CDB, CDEB, DI, DDE, DME Tools: T245, T245G, T245P, T245N
	<b>C245938</b>	Spoon Cartridge Ø 3.8 mm Ø 0.149 in		Drag soldering	Stations: CDB, CDEB, DI, DDE, DME Tools: T245, T245G, T245P, T245N
	<b>C245790</b>	Barrel Cartridge Ø 0.8 mm Ø 0.031 in		Through-hole Cable sold/desol	Stations: CDB, CDEB, DI, DDE, DME Tools: T245, T245G, T245P, T245N
	<b>C245785</b>	Barrel Cartridge Ø 1.5 mm Ø 0.059 in		Through-hole Cable sold/desol	Stations: CDB, CDEB, DI, DDE, DME Tools: T245, T245G, T245P, T245N
	<b>C245763</b>	Barrel Cartridge Ø 2.5 mm Ø 0.098 in		Through-hole Cable sold/desol	Stations: CDB, CDEB, DI, DDE, DME Tools: T245, T245G, T245P, T245N

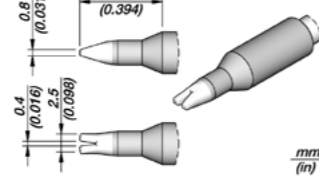
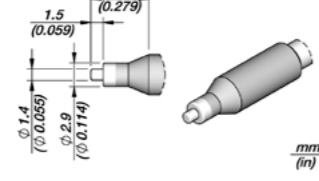
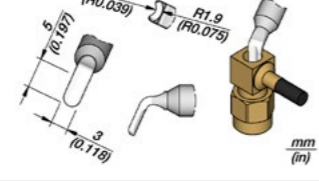
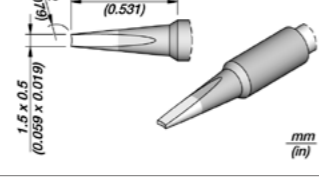
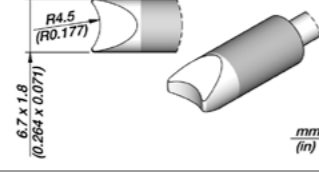

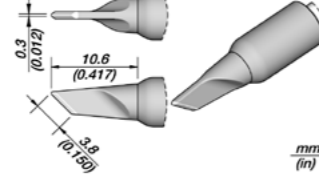
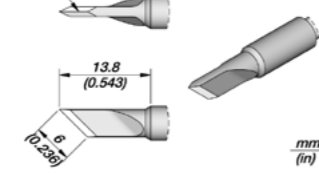

**C245 Cartridge Range for T245 General Purpose Handles**

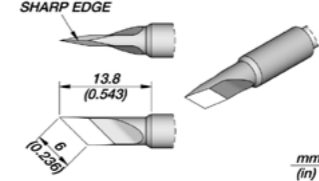
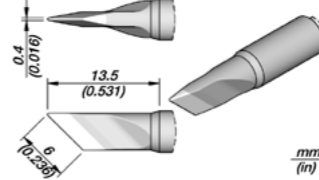
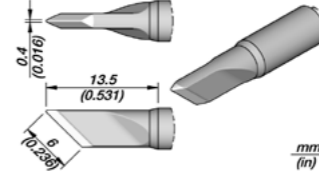
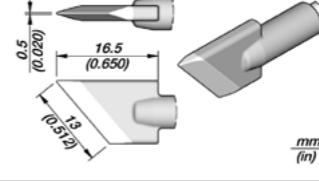
	Ref.	Description	Image and dimensions	Suggested components	Compatible with
	<b>C245760</b>	Barrel Cartridge Ø 3.5 mm Ø 0.138 in		Through-hole Cable sold/desol	Stations: CDB, CDEB, DI, DDE, DME Tools: T245, T245G, T245P, T245N
	<b>C245118</b>	Pin / Wire Cartridge 0.4 mm 0.016 in		Through-hole Wire tinning	Stations: CDB, CDEB, DI, DDE, DME Tools: T245, T245G, T245P, T245N
	<b>C245117</b>	Pin / Connector Cartridge Ø 1.4 mm Ø 0.055 in		Through-hole	Stations: CDB, CDEB, DI, DDE, DME Tools: T245, T245G, T245P, T245N
	<b>C245116</b>	Pin / Connector Cartridge R. 1 mm R. 0.039 in		Through-hole Coaxial connector	Stations: CDB, CDEB, DI, DDE, DME Tools: T245, T245G, T245P, T245N
	<b>C245122</b>	Pin / Connector Cartridge 1.5 x 0.5 mm 0.059 x 0.019 in		Cylinder parts	Stations: CDB, CDEB, DI, DDE, DME Tools: T245, T245G, T245P, T245N
	<b>C245762</b>	Round Connector Cartridge R. 4.5 mm R. 0.177 in		Cable sold/desol	Stations: CDB, CDEB, DI, DDE, DME Tools: T245, T245G, T245P, T245N
	<b>C245789</b>	Knife Cartridge 3.8 x 0.3 mm 0.150 x 0.012 in		Drag soldering	Stations: CDB, CDEB, DI, DDE, DME Tools: T245, T245G, T245P, T245N
	<b>C245941</b>	Knife Cartridge 6 x 0.3 mm 0.236 x 0.012 in		Drag soldering	Stations: CDB, CDEB, DI, DDE, DME Tools: T245, T245G, T245P, T245N

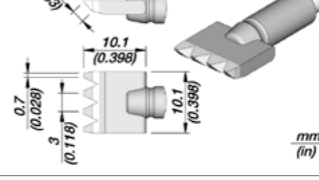
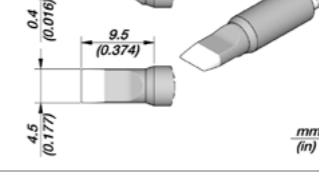
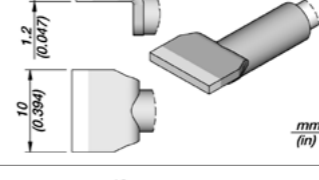
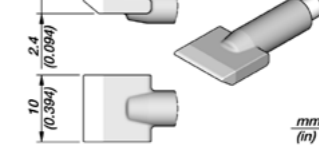

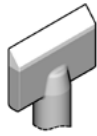
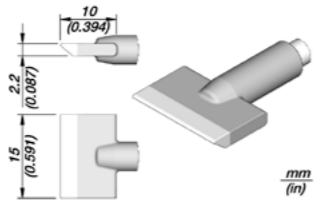
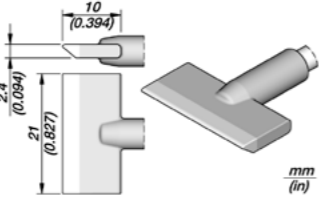
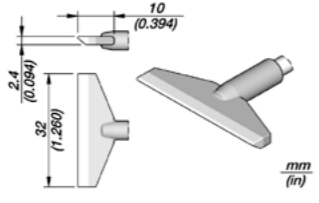
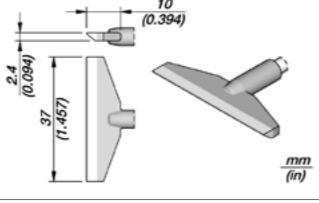
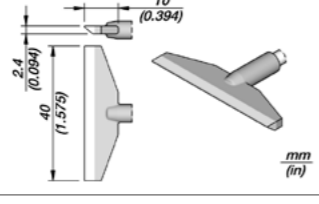

**C245 Cartridge Range for T245 General Purpose Handles**

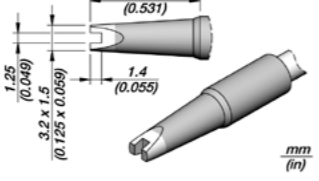
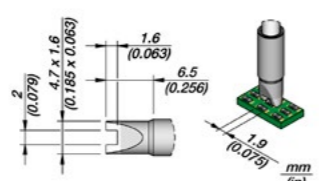
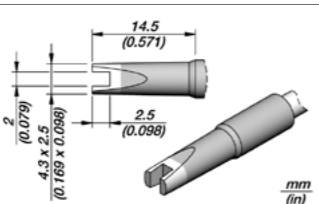
	Ref.	Description	Image and dimensions	Suggested components	Compatible with
	<b>C245940</b>	Knife Cartridge 6.0 x 0.1 mm 0.236 x 0.018 in		Drag soldering	Stations: CDB, CDEB, DI, DDE, DME Tools: T245, T245G, T245P, T245N
	<b>C245939</b>	Knife Cartridge 6.0 x 0.4 mm 0.236 x 0.016 in		Drag soldering	Stations: CDB, CDEB, DI, DDE, DME Tools: T245, T245G, T245P, T245N
	<b>C245765</b>	Knife Cartridge 6.0 x 0.4 mm S1 0.236 x 0.016 in		Drag soldering	Stations: CDB, CDEB, DI, DDE, DME Tools: T245, T245G, T245P, T245N
	<b>C245955</b>	Knife Cartridge 13 x 0.5 mm 0.512 x 0.020 in		Drag Soldering Connector desoldering	Stations: CDB, CDEB, DI, DDE, DME Tools: T245, T245G, T245P, T245N
	<b>C245728</b>	Multipad Blade Cartridge 10.1 mm 0.398 in		Connector sold / desold	Stations: CDB, CDEB, DI, DDE, DME Tools: T245, T245G, T245P, T245N
	<b>C245799</b>	Blade Cartridge 4.5 mm 0.177 in		Pad cleaning Connector desoldering	Stations: CDB, CDEB, DI, DDE, DME Tools: T245, T245G, T245P, T245N
	<b>C245730</b>	Blade Cartridge 10 mm S2 0.394 in		Pad cleaning Connector desoldering	Stations: CDB, CDEB, DI, DDE, DME Tools: T245, T245G, T245P, T245N
	<b>C245914</b>	Blade Cartridge 10 mm S1 0.394 in		Pad cleaning Connector desoldering	Stations: CDB, CDEB, DI, DDE, DME Tools: T245, T245G, T245P, T245N

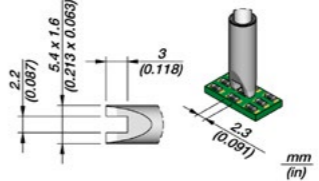
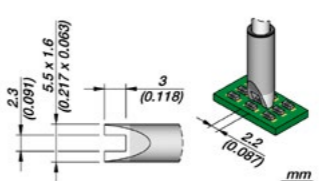
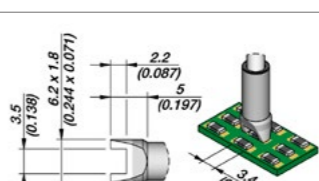
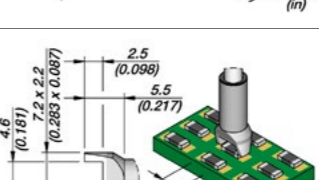

**C245 Cartridge Range for T245 General Purpose Handles**

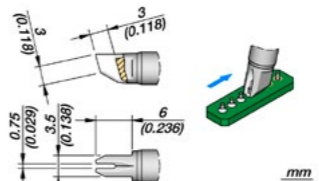
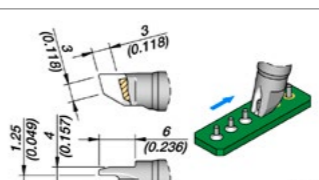
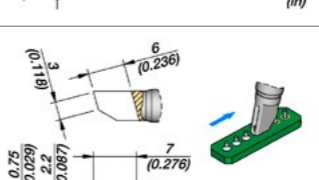
	Ref.	Description	Image and dimensions	Suggested components	Compatible with
	<b>C245752</b>	Blade Cartridge 15 mm 0.591 in		Pad cleaning Connector desoldering	Stations: CDB, CDEB, DI, DDE, DME Tools: T245, T245G, T245P, T245N
	<b>C245913</b>	Blade Cartridge 21 mm 0.827 in		Pad cleaning Connector desoldering	Stations: CDB, CDEB, DI, DDE, DME Tools: T245, T245G, T245P, T245N
	<b>C245949</b>	Blade Cartridge 32 mm 1.260 in		Pad cleaning Connector desoldering	Stations: CDB, CDEB, DI, DDE, DME Tools: T245, T245G, T245P, T245N
	<b>C245776</b>	Blade Cartridge 37 mm 1.457 in		Pad cleaning Connector desoldering	Stations: CDB, CDEB, DI, DDE, DME Tools: T245, T245G, T245P, T245N
	<b>C245792</b>	Blade Cartridge 40 mm 1.575 in		Pad cleaning Connector desoldering	Stations: CDB, CDEB, DI, DDE, DME Tools: T245, T245G, T245P, T245N
	<b>C245757</b>	Chip Cartridge 1.25 mm 0.049 in		SMD resistors SMD capacitors	Stations: CDB, CDEB, DI, DDE, DME Tools: T245, T245G, T245P, T245N
	<b>C245016</b>	Chip Cartridge 1.9 mm 0.075 in		SMD resistors SMD capacitors	Stations: CDB, CDEB, DI, DDE, DME Tools: T245, T245G, T245P, T245N
	<b>C245758</b>	Chip Cartridge 2 mm 0.079 in		SMD resistors SMD capacitors	Stations: CDB, CDEB, DI, DDE, DME Tools: T245, T245G, T245P, T245N

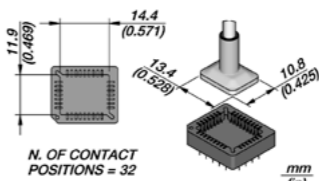
**C245 Cartridge Range for T245 General Purpose Handles**

	Ref.	Description	Image and dimensions	Suggested components	Compatible with
	<b>C245017</b>	Chip Cartridge 2.3 mm S1 0.091 in		SMD resistors SMD capacitors	Stations: CDB, CDEB, DI, DDE, DME Tools: T245, T245G, T245P, T245N
	<b>C245150</b>	Chip Cartridge 2.2 mm S2 0.087 in		SMD resistors SMD capacitors	Stations: CDB, CDEB, DI, DDE, DME Tools: T245, T245G, T245P, T245N
	<b>C245018</b>	Chip Cartridge 3.4 mm 0.134 in		SMD resistors SMD capacitors	Stations: CDB, CDEB, DI, DDE, DME Tools: T245, T245G, T245P, T245N
	<b>C245019</b>	Chip Cartridge 4.5 mm 0.177 in		SMD resistors SMD capacitors	Stations: CDB, CDEB, DI, DDE, DME Tools: T245, T245G, T245P, T245N
		<b>C245754</b>	Drag Cartridge 0.75 mm 0.029 in		Drag soldering
<b>C245751</b>		Drag Cartridge 1.25 mm 0.049 in		Drag soldering	Stations: CDB, CDEB, DI, DDE, DME Tools: T245, T245G, T245P, T245N
<b>C245796</b>		Drag Cartridge 2.2 x 0.75 mm 0.087 x 0.029 in		Drag soldering	Stations: CDB, CDEB, DI, DDE, DME Tools: T245, T245G, T245P, T245N
	<b>C245248</b>	Socket Cartridge 11.9 x 14.4 mm 0.469 x 0.571 in	 N. OF CONTACT POSITIONS = 32	PLCC sockets	Stations: CDB, CDEB, DI, DDE, DME Tools: T245, T245G, T245P, T245N

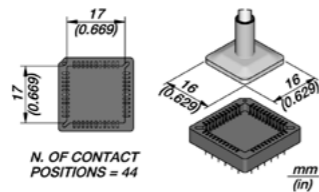
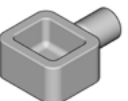
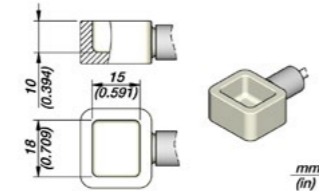
**C245 Cartridge Range for T245 General Purpose Handles**

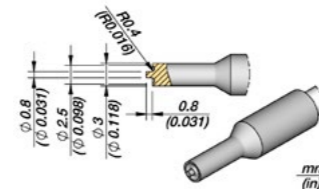
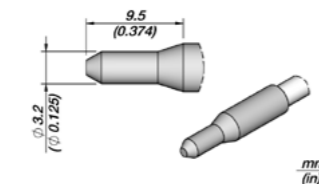
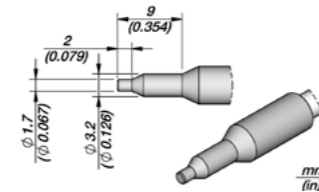
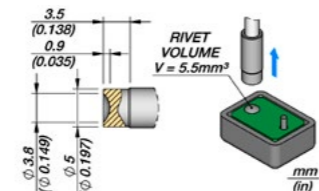
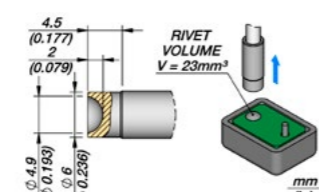
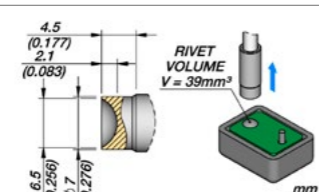
	Ref.	Description	Image and dimensions	Suggested components	Compatible with
	<b>C245247</b>	Socket Cartridge 17 x 17 mm 0.669 x 0.669 in		PLCC sockets	Stations: CDB, CDEB, DI, DDE, DME Tools: T245, T245G, T245P, T245N
	<b>C245SP01</b>	Solder Pot Cartridge 15 x 18 mm 0.591 x 0.709 in		Tinning wires, Desoldering and Through-hole Multipin components	Stations: CDB, CDEB, DI, DDE, DME Tools: T245, T245G, T245P, T245N
	<b>C245163</b>	Hollow Heat Staking Cartridge Ø 2.5 mm Ø 0.098 in		Chrome finish, design for plastic rivets	Stations: CDB, CDEB, DI, DDE, DME Tools: T245, T245G, T245P, T245N
	<b>C245688</b>	Heat Staking Bend Cartridge Ø 3.2 mm Ø 0.125 in		Plastics	Stations: CDB, CDEB, DI, DDE, DME Tools: T245, T245G, T245P, T245N
	<b>C245166</b>	Plastics Inox. Cartridge Ø 1.7 mm Ø 0.067 in		Plastics	Stations: CDB, CDEB, DI, DDE, DME Tools: T245, T245G, T245P, T245N
	<b>C245053</b>	Heat Staking Cartridge Ø 3.8 mm Ø 0.149 in		Chrome finish, design for plastic rivets	Stations: CDB, CDEB, DI, DDE, DME Tools: T245, T245G, T245P, T245N
	<b>C245052</b>	Heat Staking Cartridge Ø 4.9 mm Ø 0.193 in		Chrome finish, design for plastic rivets	Stations: CDB, CDEB, DI, DDE, DME Tools: T245, T245G, T245P, T245N
	<b>C245054</b>	Heat Staking Cartridge Ø 6.5 mm Ø 0.256 in		Chrome finish, design for plastic rivets	Stations: CDB, CDEB, DI, DDE, DME Tools: T245, T245G, T245P, T245N

**C245 Cartridge Range for T245 General Purpose Handles**

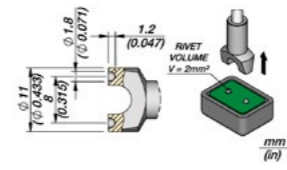
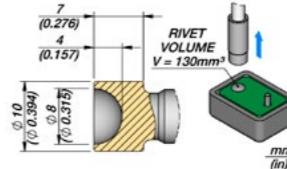
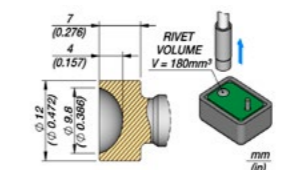
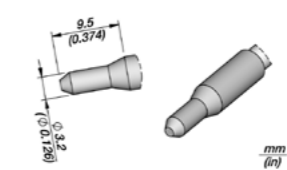
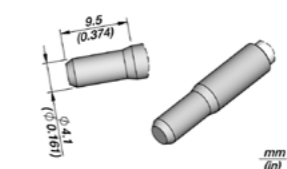
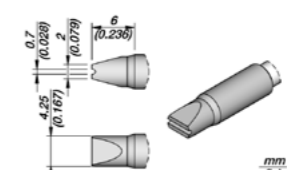
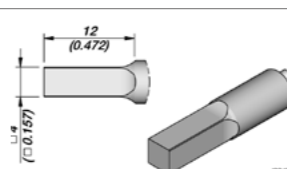
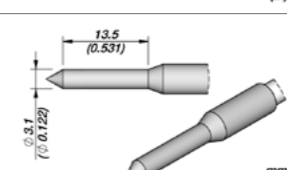
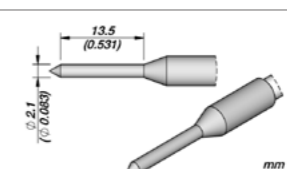
	Ref.	Description	Image and dimensions	Suggested components	Compatible with
	<b>C245143</b>	Double Heat Staking Cartridge Ø 1.8 mm Ø 0.071 in		Chrome finish, design for plastic rivets	Stations: CDB, CDEB, DI, DDE, DME Tools: T245, T245G, T245P, T245N
	<b>C245798</b>	Heat Staking Cartridge Ø 8 mm Ø 0.315 in		Chrome finish, design for plastic rivets	Stations: CDB, CDEB, DI, DDE, DME Tools: T245, T245G, T245P, T245N
	<b>C245791</b>	Heat Staking Cartridge Ø 9.8 mm Ø 0.386 in		Chrome finish, design for plastic rivets	Stations: CDB, CDEB, DI, DDE, DME Tools: T245, T245G, T245P, T245N
	<b>C245312</b>	Heat Staking Cartridge Ø 3.2 mm Ø 0.126 in		Plastics	Stations: CDB, CDEB, DI, DDE, DME Tools: T245, T245G, T245P, T245N
	<b>C245313</b>	Cartridge for Plastics Ø 4.1 mm Ø 0.161 in		Plastics	Stations: CDB, CDEB, DI, DDE, DME Tools: T245, T245G, T245P, T245N
	<b>C245124</b>	Cartridge for Plastics 4.25 x 2 mm 0.167 x 0.079 in		Plastics	Stations: CDB, CDEB, DI, DDE, DME Tools: T245, T245G, T245P, T245N
	<b>C245123</b>	Cartridge for Plastics 4 x 4 mm 0.157 in		Plastics	Stations: CDB, CDEB, DI, DDE, DME Tools: T245, T245G, T245P, T245N
	<b>C245168</b>	Thermal Hole-Punch Cartridge for Plastic Ø 3.1 mm Ø 0.122 in		Plastics	Stations: CDB, CDEB, DI, DDE, DME Tools: T245, T245G, T245P, T245N
	<b>C245167</b>	Thermal Hole-Punch Cartridge for Plastic Ø 2.1 mm Ø 0.083 in		Plastics	Stations: CDB, CDEB, DI, DDE, DME Tools: T245, T245G, T245P, T245N

**C245 Cartridge Range for T245 General Purpose Handles**

Ref.	Description	Image and dimensions	Suggested components	Compatible with
<b>C245311</b>	Cartridge for Plastics 20 x 6 mm 0.787 x 0.256 in		Plastics	Stations: CDB, CDEB, DI, DDE, DME Tools: T245, T245G, T245P, T245N
<b>C245109</b>	Conformal Coating Removal Cartridge 4.3 x 0.1 mm 0.169 x 0.004 in		Remove underfill encapsulants	Stations: CDB, CDEB, DI, DDE, DME Tools: T245, T245G, T245P, T245N
<b>C245138</b>	Cutter Cartridge 12 mm 0.472 in		Plastic Rubber cutter	Stations: CDB, CDEB, DI, DDE, DME Tools: T245, T245G, T245P, T245N
<b>C245121</b>	Cutter Cartridge 13 mm 0.512 in		Plastic Rubber cutter	Stations: CDB, CDEB, DI, DDE, DME Tools: T245, T245G, T245P, T245N
<b>C245764</b>	Fine Pitch Cartridge Ø 0.5 mm Ø 0.019 in		Package 0603 QFP, IC Fine pitch	Stations: CDB, CDEB, DI, DDE, DME Tools: T245, T245G, T245P, T245N
<b>C245119</b>	Conical Teflon Cartridge Ø 1 mm Ø 0.039 in		Plastics	Stations: CDB, CDEB, DI, DDE, DME Tools: T245, T245G, T245P, T245N
<b>C245771</b>	Bent Cartridge 1 x 0.1 mm 0.039 x 0.004 in		Cable soldering to connector Fine pitch	Stations: CDB, CDEB, DI, DDE, DME Tools: T245, T245G, T245P, T245N
<b>C245772</b>	Nickel Cartridge Ø 1.4 x 0.7 mm S1 Ø 0.055 x 0.028 in		HMP Soldering	Stations: CDB, CDEB, DI, DDE, DME Tools: T245, T245G, T245P, T245N
<b>C245268</b>	Pin/Wire Cartridge 1.5 mm 0.059 in		Through-hole	Stations: CDB, CDEB, DI, DDE, DME Tools: T245, T245G, T245P, T245N

**C245 Cartridge Range for T245 General Purpose Handles**



Ref.	Description	Image and dimensions	Suggested components	Compatible with
<b>C245010</b>	J-Lead Cartridge 4.4 x 1.8 mm 0.177 x 0.071 in		Drag Soldering J-lead	Stations: CDB, CDEB, DI, DDE, DME Tools: T245, T245G, T245P, T245N
<b>C245009</b>	S-Lead Cartridge 4.5 x 1.8 mm 0.177 x 0.071 in		Drag Soldering	Stations: CDB, CDEB, DI, DDE, DME Tools: T245, T245G, T245P, T245N
<b>C245136</b>	Micro Stick Switch Cartridge 7.1 x 6.5 mm 0.279 x 0.256 in		Micro Stick desoldering	Stations: CDB, CDEB, DI, DDE, DME Tools: T245, T245G, T245P, T245N

**C245L Longer Cartridge Range for T245 General Purpose Handles**



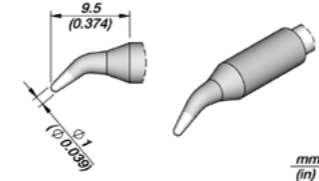

C245L Cartridges are 20mm longer for easier access to difficult-to-reach joints.

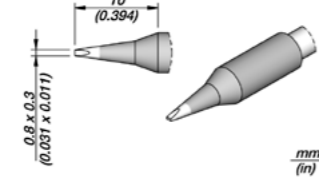
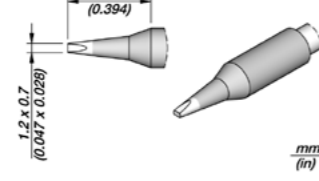
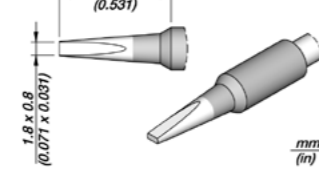
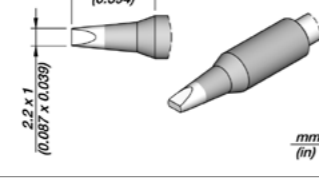
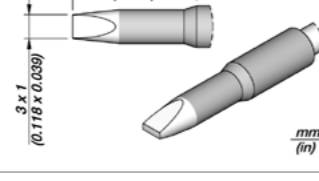
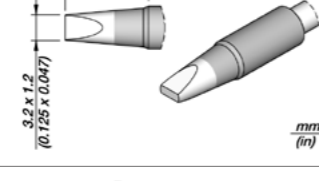
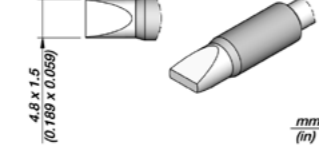
Ref.	Description	Image and dimensions	Suggested components	Compatible with
<b>C245230</b>	Conical Cartridge Ø 0.3 mm L Ø 0.012 in		General use	Stations: CDB, CDEB, DI, DDE, DME Tools: T245, T245G, T245P, T245N
<b>C245201</b>	Conical Cartridge Ø 0.6 mm L Ø 0.024 in		Package 0603 QFP, IC	Stations: CDB, CDEB, DI, DDE, DME Tools: T245, T245G, T245P, T245N
<b>C245803</b>	Conical Cartridge Ø 1 mm L Ø 0.040 in		General use	Stations: CDB, CDEB, DI, DDE, DME Tools: T245, T245G, T245P, T245N
<b>C245234</b>	Conical Bent Cartridge Ø 0.4 mm S1 L Ø 0.016 in		Package 0201, 0402 Fine pitch 0.65 mm QFP, IC	Stations: CDB, CDEB, DI, DDE, DME Tools: T245, T245G, T245P, T245N

**C245L Longer Cartridge Range for T245 General Purpose Handles**

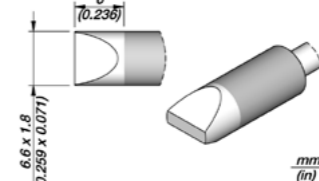
	Ref.	Description	Image and dimensions	Suggested components	Compatible with
	<b>C245804</b>	Conical Bent Cartridge Ø 1 mm L Ø 0.039 in		General use	Stations: CDB, CDEB, DI, DDE, DME Tools: T245, T245G, T245P, T245N
	<b>C245673</b>	Chisel Cartridge 0.8 x 0.3 mm L 0.031 x 0.011 in		Package 0805 Through-hole	Stations: CDB, CDEB, DI, DDE, DME Tools: T245, T245G, T245P, T245N
	<b>C245806</b>	Chisel Cartridge 1.2 x 0.7 mm L 0.047 x 0.028 in		General use	Stations: CDB, CDEB, DI, DDE, DME Tools: T245, T245G, T245P, T245N
	<b>C245844</b>	Chisel Cartridge 1.8 x 0.8 mm L 0.071 x 0.031 in		General use	Stations: CDB, CDEB, DI, DDE, DME Tools: T245, T245G, T245P, T245N
	<b>C245807</b>	Chisel Cartridge 2.2 x 1 mm L 0.087 x 0.039 in		General use	Stations: CDB, CDEB, DI, DDE, DME Tools: T245, T245G, T245P, T245N
	<b>C245261</b>	Chisel Cartridge 3 x 1 mm L 0.118 x 0.039 in		General use	Stations: CDB, CDEB, DI, DDE, DME Tools: T245, T245G, T245P, T245N
	<b>C245811</b>	Chisel Cartridge 3.2 x 1.2 mm L 0.125 x 0.047 in		General use	Stations: CDB, CDEB, DI, DDE, DME Tools: T245, T245G, T245P, T245N
	<b>C245808</b>	Chisel Cartridge 4.8 x 1.5 mm HT L 0.189 x 0.059 in		General use	Stations: CDB, CDEB, DI, DDE, DME Tools: T245, T245G, T245P, T245N

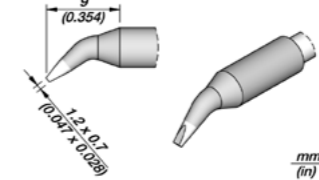
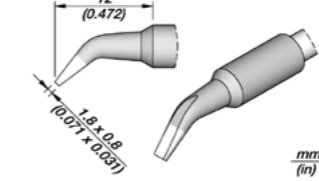
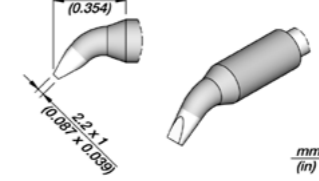
**C245L Longer Cartridge Range for T245 General Purpose Handles**

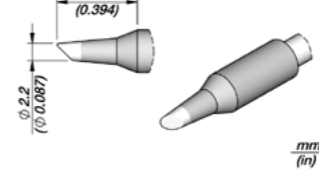
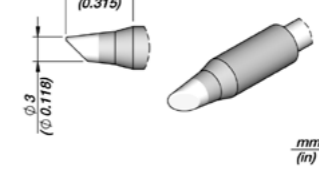
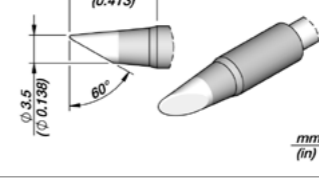
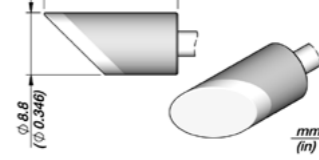
	Ref.	Description	Image and dimensions	Suggested components	Compatible with
	<b>C245866</b>	Chisel Cartridge 6.6 x 1.8 mm HT L 0.259 x 0.071 in		General use	Stations: CDB, CDEB, DI, DDE, DME Tools: T245, T245G, T245P, T245N
	<b>C245862</b>	Chisel Bent Cartridge 1.2 x 0.7 mm L 0.047 x 0.028 in		General use	Stations: CDB, CDEB, DI, DDE, DME Tools: T245, T245G, T245P, T245N
	<b>C245863</b>	Chisel Bent Cartridge 1.8 x 0.8 mm L 0.071 x 0.031 in		General use	Stations: CDB, CDEB, DI, DDE, DME Tools: T245, T245G, T245P, T245N
	<b>C245846</b>	Chisel Bent Cartridge 2.2 x 1 mm L 0.087 x 0.039 in		General use	Stations: CDB, CDEB, DI, DDE, DME Tools: T245, T245G, T245P, T245N
	<b>C245845</b>	Bevel Cartridge Ø 2.2 mm L Ø 0.087 in		Drag soldering Through-hole	Stations: CDB, CDEB, DI, DDE, DME Tools: T245, T245G, T245P, T245N
	<b>C245812</b>	Bevel Cartridge Ø 3 mm L Ø 0.118 in		Drag soldering Through-hole	Stations: CDB, CDEB, DI, DDE, DME Tools: T245, T245G, T245P, T245N
	<b>C245256</b>	Bevel Cartridge Ø 3.5 mm HT L Ø 0.138 in		Drag soldering Through-hole	Stations: CDB, CDEB, DI, DDE, DME Tools: T245, T245G, T245P, T245N
	<b>C245301</b>	Bevel Cartridge Ø 8.8 mm Ø 0.346 in		Wide area	Stations: CDB, CDEB, DI, DDE, DME Tools: T245, T245G, T245P, T245N

**C245L Longer Cartridge Range for T245 General Purpose Handles**

Ref.	Description	Image and dimensions	Suggested components	Compatible with
<b>C245662</b>	Round Connector Cartridge R. 4.5 mm L R. 0.177 in		Cable sold/desol	Stations: CDB, CDEB, DI, DDE, DME Tools: T245, T245G, T245P, T245N
<b>C245658</b>	Chip Cartridge 2.0 mm L 0.078 in		SMD resistors SMD capacitors	Stations: CDB, CDEB, DI, DDE, DME Tools: T245, T245G, T245P, T245N
<b>C245654</b>	Drag Cartridge 0.75 mm L 0.029 in		Drag soldering	Stations: CDB, CDEB, DI, DDE, DME Tools: T245, T245G, T245P, T245N
<b>C245651</b>	Drag Cartridge 1.25 mm L 0.049 in		Drag soldering	Stations: CDB, CDEB, DI, DDE, DME Tools: T245, T245G, T245P, T245N
<b>C245667</b>	Drag Cartridge 1.25 mm S1 L 0.049 in		Drag soldering	Stations: CDB, CDEB, DI, DDE, DME Tools: T245, T245G, T245P, T245N
<b>C245669</b>	Drag Cartridge 1.25 mm S2 L 0.049 in		Drag soldering	Stations: CDB, CDEB, DI, DDE, DME Tools: T245, T245G, T245P, T245N
<b>C245220</b>	Tunnel Cartridge 5.4 x 6 mm 0.213 x 0.236 in		Dual in Line IC	Stations: CDB, CDEB, DI, DDE, DME Tools: T245, T245G, T245P, T245N
<b>C245250</b>	Tunnel Cartridge 5.4 x 8 mm 0.213 x 0.315 in		Dual in Line IC	Stations: CDB, CDEB, DI, DDE, DME Tools: T245, T245G, T245P, T245N

**C245L Longer Cartridge Range for T245 General Purpose Handles**





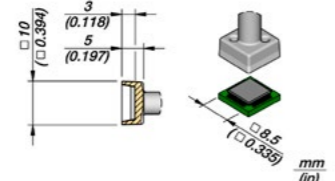
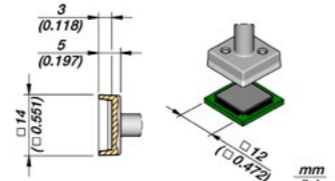
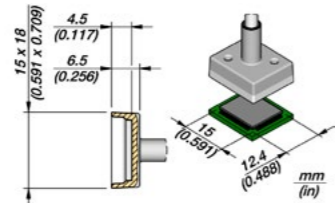
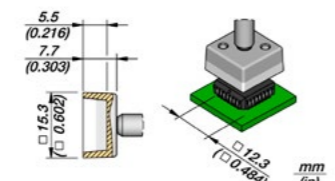
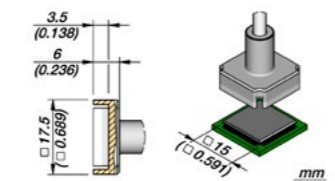
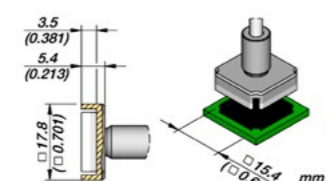
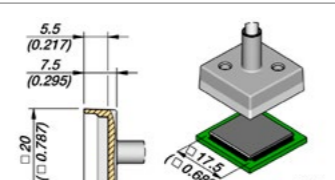
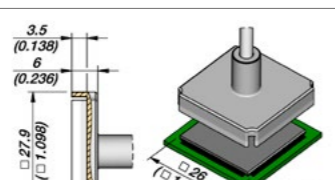

Ref.	Description	Image and dimensions	Suggested components	Compatible with
<b>C245221</b>	Tunnel Cartridge 5.4 x 10 mm 0.213 x 0.394 in		Dual in Line IC	Stations: CDB, CDEB, DI, DDE, DME Tools: T245, T245G, T245P, T245N
<b>C245303</b>	Tunnel Cartridge 6.5 x 6 mm 0.256 x 0.236 in		Dual in Line IC	Stations: CDB, CDEB, DI, DDE, DME Tools: T245, T245G, T245P, T245N
<b>C245222</b>	Tunnel Cartridge 7.1 x 13 mm 0.279 x 0.512 in		Dual in Line IC	Stations: CDB, CDEB, DI, DDE, DME Tools: T245, T245G, T245P, T245N
<b>C245306</b>	Tunnel Cartridge 9.6 x 10 mm 0.378 x 0.394 in		Dual in Line IC	Stations: CDB, CDEB, DI, DDE, DME Tools: T245, T245G, T245P, T245N
<b>C245305</b>	Tunnel Cartridge 9.6 x 12 mm 0.378 x 0.472 in		Dual in Line IC	Stations: CDB, CDEB, DI, DDE, DME Tools: T245, T245G, T245P, T245N
<b>C245304</b>	Tunnel Cartridge 9.6 x 15 mm 0.378 x 0.591 in		Dual in Line, IC	Stations: CDB, CDEB, DI, DDE, DME Tools: T245, T245G, T245P, T245N
<b>C245215</b>	Tunnel Cartridge 9.6 x 18 mm 0.378 x 0.709 in		Dual in Line IC	Stations: CDB, CDEB, DI, DDE, DME Tools: T245, T245G, T245P, T245N
<b>C245226</b>	Tunnel Cartridge 15.2 x 29 mm 0.598 x 1.142 in		Dual in Line IC	Stations: CDB, CDEB, DI, DDE, DME Tools: T245, T245G, T245P, T245N

**C245L** Longer Cartridge Range for T245 General Purpose Handles

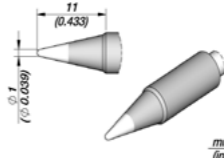

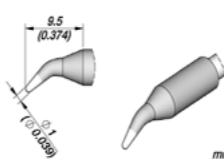
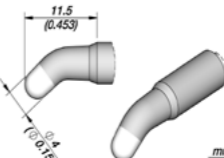

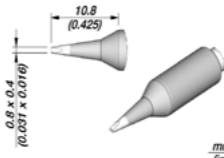
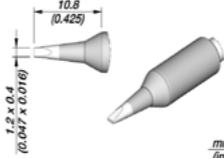
Ref.	Description	Image and dimensions	Suggested components	Compatible with
 <b>C245223</b>	QFP Cartridge 8.5 x 8.5 mm 0.335 x 0.335 in		QFP	Stations: CDB, CDEB, DI, DDE, DME Tools: T245, T245G, T245P, T245N
<b>C245224</b>	QFP Cartridge 12 x 12 mm 0.472 x 0.472 in		QFP	Stations: CDB, CDEB, DI, DDE, DME Tools: T245, T245G, T245P, T245N
<b>C245228</b>	QFP Cartridge 12.4 x 15 mm 0.488 x 0.591 in		QFP	Stations: CDB, CDEB, DI, DDE, DME Tools: T245, T245G, T245P, T245N
<b>C245351</b>	QFP Cartridge 12.3 x 12.3 mm 0.484 x 0.484 in		QFP	Stations: CDB, CDEB, DI, DDE, DME Tools: T245, T245G, T245P, T245N
<b>C245315</b>	QFP Cartridge 15 x 15 mm 0.591 x 0.591 in		QFP	Stations: CDB, CDEB, DI, DDE, DME Tools: T245, T245G, T245P, T245N
<b>C245352</b>	QFP Cartridge 15.4 x 15.4 mm 0.606 x 0.606 in		QFP	Stations: CDB, CDEB, DI, DDE, DME Tools: T245, T245G, T245P, T245N
<b>C245227</b>	QFP Cartridge 17.5 x 17.5 mm 0.689 x 0.689 in		QFP	Stations: CDB, CDEB, DI, DDE, DME Tools: T245, T245G, T245P, T245N
<b>C245344</b>	QFP Cartridge 26 x 26 mm 1.024 x 1.024 in		QFP	Stations: CDB, CDEB, DI, DDE, DME Tools: T245, T245G, T245P, T245N

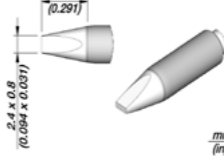
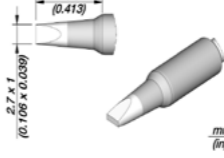
**C245E** Extended Tip Life Cartridge Range for T245 General Purpose Handles

C245E Cartridges have a reinforced protection on the tip that provides a longer life with a small reduction of thermal efficiency.

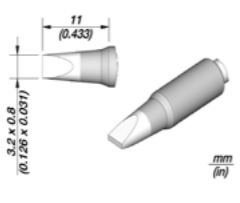
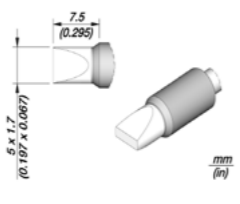
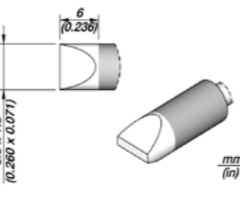

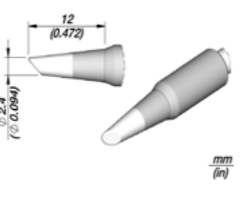
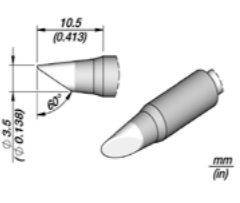
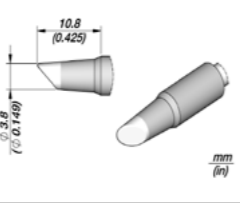
Ref.	Description	Image and dimensions	Suggested components	Compatible with
 <b>C245736E</b>	Conical Cartridge Ø 1 mm Ø 0.039 in		General use	Stations: CDB, CDEB, DI, DDE, DME Tools: T245, T245G, T245P, T245N
 <b>C245909E</b>	Conical Bent Cartridge Ø 1 mm Ø 0.039 in		General use	Stations: CDB, CDEB, DI, DDE, DME Tools: T245, T245G, T245P, T245N
<b>C245629E</b>	Conical Bent Cartridge Ø 4 mm Ø 0.157 in		General use	Stations: CDB, CDEB, DI, DDE, DME Tools: T245, T245G, T245P, T245N
 <b>C245159E</b>	Chisel Cartridge 0.8 x 0.4 mm 0.031 x 0.016 in		General use	Stations: CDB, CDEB, DI, DDE, DME Tools: T245, T245G, T245P, T245N
<b>C245158E</b>	Chisel Cartridge 1.2 x 0.4 mm 0.047 x 0.016 in		General use	Stations: CDB, CDEB, DI, DDE, DME Tools: T245, T245G, T245P, T245N
<b>C245160E</b>	Chisel Cartridge 1.6 x 0.5 mm 0.063 x 0.020 in		General use	Stations: CDB, CDEB, DI, DDE, DME Tools: T245, T245G, T245P, T245N
<b>C245155E</b>	Chisel Cartridge 2.4 x 0.8 mm 0.094 x 0.031 in		General use	Stations: CDB, CDEB, DI, DDE, DME Tools: T245, T245G, T245P, T245N
<b>C245735E</b>	Chisel Cartridge 2.7 x 1 mm 0.106 x 0.039 in		General use	Stations: CDB, CDEB, DI, DDE, DME Tools: T245, T245G, T245P, T245N

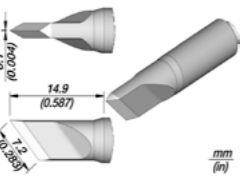
**C245E** Extended Tip Life Cartridge Range for T245 General Purpose Handles

	Ref.	Description	Image and dimensions	Suggested components	Compatible with
	<b>C245161E</b>	Chisel Cartridge 3.2 x 0.8 mm 0.126 x 0.031 in		General use	Stations: CDB, CDEB, DI, DDE, DME Tools: T245, T245G, T245P, T245N
	<b>C245070E</b>	Chisel Cartridge 5 x 1.7 mm 0.197 x 0.067 in		General use	Stations: CDB, CDEB, DI, DDE, DME Tools: T245, T245G, T245P, T245N
	<b>C245968E</b>	Chisel Cartridge 6.6 x 1.8 mm 0.260 x 0.071 in		General use	Stations: CDB, CDEB, DI, DDE, DME Tools: T245, T245G, T245P, T245N
	<b>C245156E</b>	Bevel Cartridge Ø 2.4 mm Ø 0.094 in		Drag soldering Through-hole	Stations: CDB, CDEB, DI, DDE, DME Tools: T245, T245G, T245P, T245N
	<b>C245354E</b>	Bevel Cartridge Ø 3.5 mm L Ø 0.138 in		Drag soldering Through-hole	Stations: CDB, CDEB, DI, DDE, DME Tools: T245, T245G, T245P, T245N
	<b>C245952E</b>	Bevel Cartridge Ø 3.8 mm Ø 0.149 in		Drag soldering Through-hole	Stations: CDB, CDEB, DI, DDE, DME Tools: T245, T245G, T245P, T245N
	<b>C245157E</b>	Knife Cartridge 7.2 mm 0.283 in		Drag soldering Through-hole	Stations: CDB, CDEB, DI, DDE, DME Tools: T245, T245G, T245P, T245N



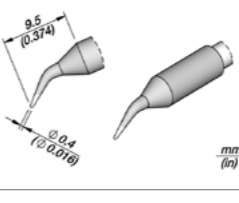
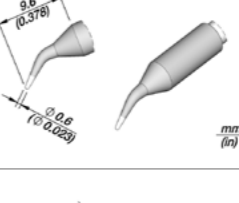
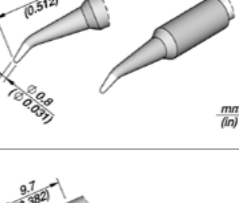
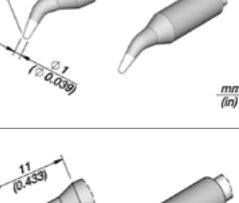
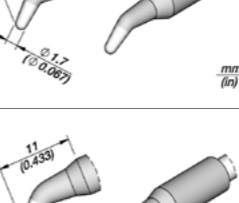
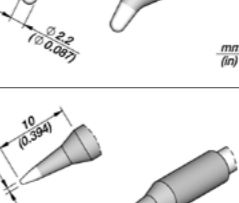

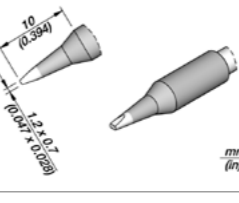
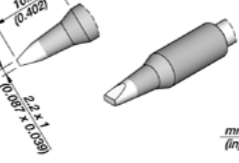

**C250** Cartridge Range  
for **ALE250** Auto-Feed Iron and **AP250** Solder Feed Iron

	Ref.	Description	Image and dimensions	Suggested components	Compatible with	
	<b>C250420</b>	Conical Bent Cartridge Ø 0.4 mm Ø 0.016 in		Package 0201, 0402 Fine pitch 0.65 mm QFP, IC	Stations: ALE, CA Tools: ALE250, AP250	
	<b>C250401</b>	Conical Bent Cartridge Ø 0.6 mm Ø 0.023 in		Package 0603 QFP, IC	Stations: ALE, CA Tools: ALE250, AP250	
	<b>C250402</b>	Conical Bent Cartridge Ø 0.8 mm Ø 0.031 in		General use	Stations: ALE, CA Tools: ALE250, AP250	
	<b>C250403</b>	Conical Bent Cartridge Ø 1 mm Ø 0.039 in		General use	Stations: ALE, CA Tools: ALE250, AP250	
	<b>C250409</b>	Conical Bent Cartridge Ø 1.7 mm Ø 0.067 in		General use	Stations: ALE, CA Tools: ALE250, AP250	
	<b>C250410</b>	Conical Bent Cartridge Ø 2.2 mm Ø 0.087 in		General use	Stations: ALE, CA Tools: ALE250, AP250	
		<b>C250407</b>	Chisel Cartridge 1.2 x 0.7 mm 0.047 x 0.028 in		General use	Stations: ALE, CA Tools: ALE250, AP250
		<b>C250408</b>	Chisel Cartridge 2.2 x 1 mm S1 0.087 x 0.039 in		General use	Stations: ALE, CA Tools: ALE250, AP250

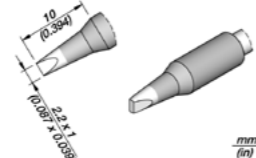
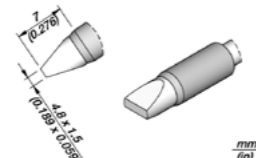

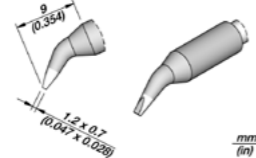
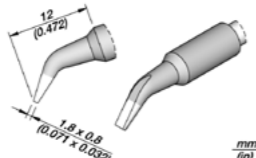
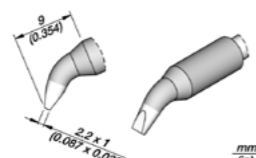
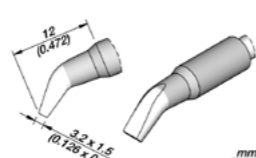
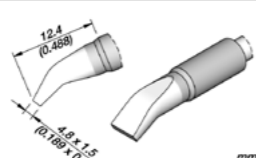
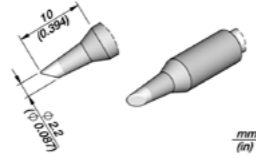
**C250 Cartridge Range for ALE250 Auto-Feed Iron and AP250 Solder Feed Iron**

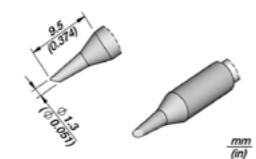

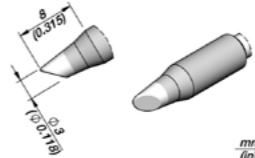
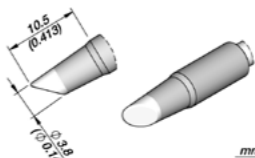

	Ref.	Description	Image and dimensions	Suggested components	Compatible with
	<b>C250413</b>	Chisel Cartridge 2.2 x 1 mm S2 0.087 x 0.039 in		General use	Stations: ALE, CA Tools: ALE250, AP250
	<b>C250411</b>	Chisel Cartridge 4.8 x 1.5 mm 0.189 x 0.059 in		General use	Stations: ALE, CA Tools: ALE250, AP250
	<b>C250404</b>	Chisel Bent Cartridge 1.2 x 0.7 mm 0.047 x 0.028 in		General use	Stations: ALE, CA Tools: ALE250, AP250
	<b>C250405</b>	Chisel Bent Cartridge 1.8 x 0.8 mm 0.071 x 0.032 in		General use	Stations: ALE, CA Tools: ALE250, AP250
	<b>C250406</b>	Chisel Bent Cartridge 2.2 x 1 mm 0.087 x 0.039 in		General use	Stations: ALE, CA Tools: ALE250, AP250
	<b>C250418</b>	Chisel Bent Cartridge 3.2 x 1.5 mm 0.126 x 0.059 in		General use	Stations: ALE, CA Tools: ALE250, AP250
	<b>C250412</b>	Chisel Bent Cartridge 4.8 x 1.5 mm 0.189 x 0.059 in		General use	Stations: ALE, CA Tools: ALE250, AP250
	<b>C250414</b>	Bevel Cartridge Ø 2.2 mm Ø 0.087 in		Drag soldering Through-hole	Stations: ALE, CA Tools: ALE250, AP250
	<b>C250426</b>	Bevel Cartridge Ø 1.3 mm Ø 0.051 in		Drag soldering Through-hole	Stations: ALE, CA Tools: ALE250, AP250

**C250 Cartridge Range for ALE250 Auto-Feed Iron and AP250 Solder Feed Iron**

	Ref.	Description	Image and dimensions	Suggested components	Compatible with
	<b>C250424</b>	Bevel Cartridge Ø 3 mm Ø 0.118 in		Drag soldering Through-hole	Stations: ALE, CA Tools: ALE250, AP250
	<b>C250415</b>	Bevel Cartridge Ø 3.8 mm Ø 0.149 in		Drag soldering Through-hole	Stations: ALE, CA Tools: ALE250, AP250

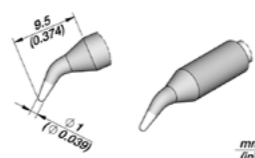
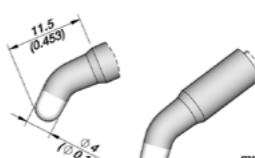
**C250E Extended Tip Life Cartridge Range for ALE250 Auto-Feed Iron and AP250 Solder Feed Iron**

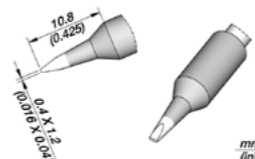
C250E Cartridges have a reinforced protection on the tip that provides a longer life with a small reduction of thermal efficiency.

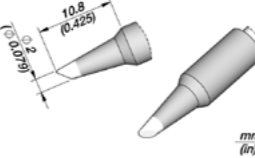
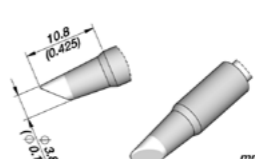
	Ref.	Description	Image and dimensions	Suggested components	Compatible with
	<b>C250428E</b>	Conical Bent Cartridge Ø 1 mm Ø 0.039 in		Package 0201, 0402 Fine pitch 0.65 mm QFP, IC	Stations: ALE, CA Tools: ALE250, AP250
	<b>C250427E</b>	Conical Bent Cartridge Ø 4 mm Ø 0.157 in		General use	Stations: ALE, CA Tools: ALE250, AP250
	<b>C250432E</b>	Chisel Cartridge 0.4 x 1.2 mm 0.016 x 0.047 in		General use	Stations: ALE, CA Tools: ALE250, AP250
	<b>C250433E</b>	Bevel Cartridge Ø 2 mm Ø 0.079 in		Drag soldering Through-hole	Stations: ALE, CA Tools: ALE250, AP250
	<b>C250429E</b>	Bevel Cartridge Ø 3.8 mm Ø 0.150 in		Drag soldering Through-hole	Stations: ALE, CA Tools: ALE250, AP250



**C420 Cartridge Range**  
for AT420 and HT420 Thermal Tweezers

Ref.	Description	Image and dimensions	Suggested components	Compatible with
<b>C420271</b>	Chip Cartridge 1.5 mm 0.059 in		SMD resistors SMD capacitors	Stations: DI, DDE, DME Tools: AT420, HT420
<b>C420287</b>	Chip Cartridge 2 mm 0.079 in		Customized	Stations: DI, DDE, DME Tools: AT420, HT420
<b>C420272</b>	Chip Cartridge 2.6 mm 0.102 in		SMD resistors SMD capacitors	Stations: DI, DDE, DME Tools: AT420, HT420
<b>C420273</b>	Blade Cartridge 4 mm 0.157 in		Package 1210, 1812 SO, SOT DIP	Stations: DI, DDE, DME Tools: AT420, HT420
<b>C420274</b>	Blade Cartridge 6 mm 0.236 in		DIP IC	Stations: DI, DDE, DME Tools: AT420, HT420
<b>C420275</b>	Blade Cartridge 8 mm 0.315 in		DIP IC	Stations: DI, DDE, DME Tools: AT420, HT420
<b>C420276</b>	Blade Cartridge 10 mm 0.394 in		DIP IC	Stations: DI, DDE, DME Tools: AT420, HT420

**C420 Cartridge Range** for AT420 and HT420 Thermal Tweezers

Ref.	Description	Image and dimensions	Suggested components	Compatible with
<b>C420277</b>	Blade Cartridge 15 mm 0.591 in		DIP IC	Stations: DI, DDE, DME Tools: AT420, HT420
<b>C420278</b>	Blade Cartridge 20 mm 0.787 in		DIP IC	Stations: DI, DDE, DME Tools: AT420, HT420
<b>C420285</b>	Blade Cartridge 22 mm 0.866 in		DIP IC	Stations: DI, DDE, DME Tools: AT420, HT420
<b>C420283</b>	Blade Cartridge 50 mm 1.968 in		Pad cleaning Connector desoldering	Stations: DI, DDE, DME Tools: AT420, HT420
<b>C420279</b>	QFP Cartridge 8 mm 0.315 in		QFP PLCC	Stations: DI, DDE, DME Tools: AT420, HT420
<b>C420280</b>	QFP Cartridge 11 mm 0.433 in		QFP PLCC	Stations: DI, DDE, DME Tools: AT420, HT420
<b>C420288</b>	QFP Cartridge 14.5 mm 0.571 in		QFP PLCC	Stations: DI, DDE, DME Tools: AT420, HT420
<b>C420286</b>	"U" Shape Cartridge 15.6 x 14.3 mm 0.614 x 0.563 in		Customized	Stations: DI, DDE, DME Tools: AT420, HT420

**C470 Cartridge Range**

for **T470** HD Handles and **HT470** HD Thermal Tweezers





	Ref.	Description	Image and dimensions	Suggested components	Compatible with
	<b>C470001</b>	Conical Cartridge Ø 1.7 mm Ø 0.067 in		General use	Station: HDE Tools: T470, T470S, T470F, T470M, T470Z, T470N
	<b>C470008</b>	Conical Bent Cartridge Ø 3.5 mm Ø 0.138 in		General use	Station: HDE Tools: T470, T470S, T470F, T470M, T470Z, T470N
	<b>C470013</b>	Chisel Cartridge 2 x 0.9 mm 0.079 x 0.035 in		General use	Station: HDE Tools: T470, T470S, T470F, T470M, T470Z, T470N
	<b>C470036</b>	Chisel Cartridge 2 x 1 mm 0.079 x 0.039 in		General use	Station: HDE Tools: T470, T470S, T470F, T470M, T470Z, T470N
	<b>C470014</b>	Chisel Cartridge 4 x 1.3 mm S1 0.157 x 0.051 in		General use	Station: HDE Tools: T470, T470S, T470F, T470M, T470Z, T470N
	<b>C470040</b>	Chisel Cartridge 4 x 1.3 mm S2 0.157 x 0.051 in		General use	Station: HDE Tools: T470, T470S, T470F, T470M, T470Z, T470N
	<b>C470035</b>	Chisel Cartridge 4 x 2.5 mm 0.157 x 0.098 in		General use	Station: HDE Tools: T470, T470S, T470F, T470M, T470Z, T470N

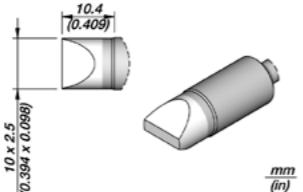
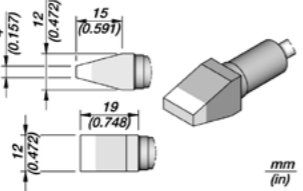
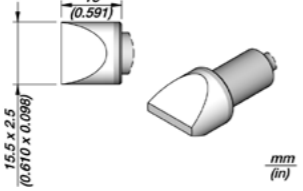
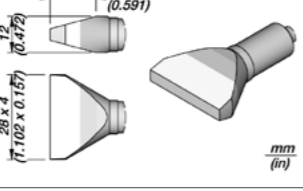
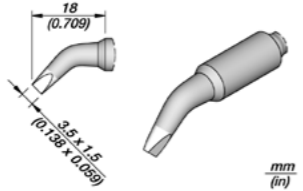
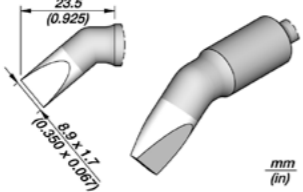

**C470 Cartridge Range for T470 HD Handles and HT470 HD Thermal Tweezers**

	Ref.	Description	Image and dimensions	Suggested components	Compatible with
	<b>C470017</b>	Chisel Cartridge 5 x 1.2 mm 0.197 x 0.047 in		General use	Station: HDE Tools: T470, T470S, T470F, T470M, T470Z, T470N
	<b>C470009</b>	Chisel Cartridge 5.5 x 1.5 mm 0.216 x 0.059 in		General use Sheet metal	Station: HDE Tools: T470, T470S, T470F, T470M, T470Z, T470N
	<b>C470002</b>	Chisel Cartridge 6 x 1.5 mm 0.236 x 0.059 in		General use Sheet metal	Station: HDE Tools: T470, T470S, T470F, T470M, T470Z, T470N
	<b>C470015</b>	Chisel Cartridge 6 x 1.7 mm 0.236 x 0.067 in		General use	Station: HDE Tools: T470, T470S, T470F, T470M, T470Z, T470N
	<b>C470004</b>	Chisel Cartridge 7.5 x 1.5 mm 0.295 x 0.059 in		General use Sheet metal	Station: HDE Tools: T470, T470S, T470F, T470M, T470Z, T470N
	<b>C470016</b>	Chisel Cartridge 7.5 x 1.7 mm 0.295 x 0.067 in		General use	Station: HDE Tools: T470, T470S, T470F, T470M, T470Z, T470N
	<b>C470058</b>	Chisel Cartridge 8 x 2.5 mm 0.315 x 0.098 in		General use Sheet metal	Station: HDE Tools: T470, T470S, T470F, T470M, T470Z, T470N
	<b>C470039</b>	Chisel Cartridge 8.5 x 2.5 mm 0.335 x 0.098 in		General use Sheet metal	Station: HDE Tools: T470, T470S, T470F, T470M, T470Z, T470N

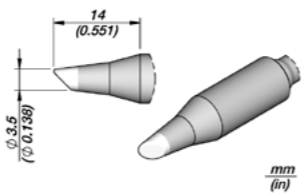
**C470 Cartridge Range for T470 HD Handles and HT470 HD Thermal Tweezers**

	Ref.	Description	Image and dimensions	Suggested components	Compatible with
	<b>C470006</b>	Chisel Cartridge 10 x 2.5 mm 0.394 x 0.098 in		General use Sheet metal	Station: HDE Tools: T470, T470S, T470F, T470M, T470Z, T470N
	<b>C470021</b>	Chisel Cartridge 12 x 4 mm 0.472 x 0.157 in		General use Sheet metal	Station: HDE Tools: T470, T470S, T470F, T470M, T470Z, T470N
	<b>C470007</b>	Chisel Cartridge 15.5 x 2.5 mm 0.610 x 0.098 in		General use Sheet metal	Station: HDE Tools: T470, T470S, T470F, T470M, T470Z, T470N
	<b>C470067</b>	Chisel Cartridge 15.5 X 2.5 mm 0.610 x 0.098 in		General use Sheet metal	Station: HDE Tools: T470, T470S, T470F, T470M, T470Z, T470N, HT470
	<b>C470022</b>	Chisel Cartridge 28 x 4 mm 1.102 x 0.157 in		Sheet metal	Station: HDE Tools: T470, T470S, T470F, T470M, T470Z, T470N
	<b>C470034</b>	Chisel Bent Cartridge 3.5 x 1.5 mm 0.138 x 0.059 in		General use	Station: HDE Tools: T470, T470S, T470F, T470M, T470Z, T470N
	<b>C470018</b>	Chisel Bent Cartridge 8.9 x 1.7 mm 0.350 x 0.067 in		General use Sheet metal	Station: HDE Tools: T470, T470S, T470F, T470M, T470Z, T470N
	<b>C470019</b>	Bevel Cartridge Ø 3.5 mm Ø 0.138 in		General use	Station: HDE Tools: T470, T470S, T470F, T470M, T470Z, T470N

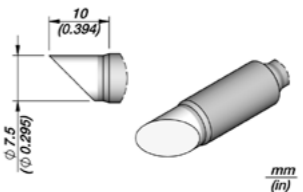
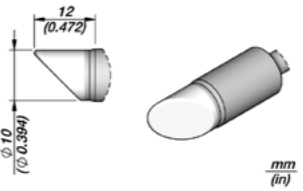

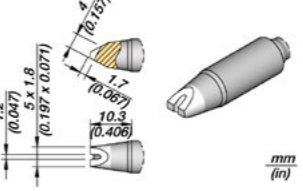
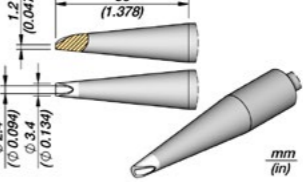
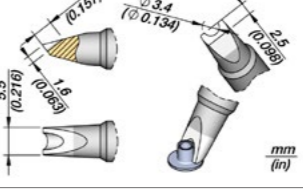
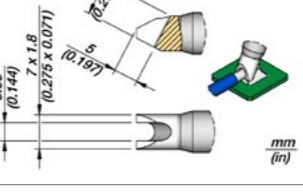
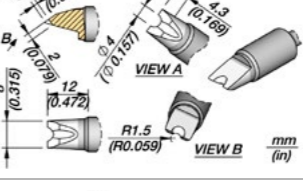
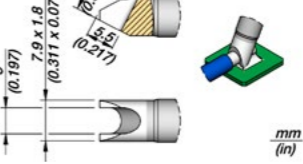

**C470 Cartridges Range for T470 HD Handles and HT470 HD Thermal Tweezers**

	Ref.	Description	Image and dimensions	Suggested components	Compatible with
	<b>C470003</b>	Bevel Cartridge Ø 7.5 mm Ø 0.295 in		General use Sheet metal	Station: HDE Tools: T470, T470S, T470F, T470M, T470Z, T470N
	<b>C470056</b>	Bevel Cartridge Ø 10 mm Ø 0.394 in		Wide area Shield desoldering Sheet metal	Station: HDE Tools: T470, T470S, T470F, T470M, T470Z, T470N
	<b>C470028</b>	Barrel Cartridge Ø 1.2 mm Ø 0.047 in		Cable Through-hole	Station: HDE Tools: T470, T470S, T470F, T470M, T470Z, T470N
	<b>C470020</b>	Barrel Cartridge Ø 2.4 mm Ø 0.094 in		Through-hole	Station: HDE Tools: T470, T470S, T470F, T470M, T470Z, T470N
	<b>C470048</b>	Barrel Cartridge Ø 3.4 mm Ø 0.134 in		Cable Through-hole	Station: HDE Tools: T470, T470S, T470F, T470M, T470Z, T470N
	<b>C470033</b>	Barrel Cartridge Ø 3.65 mm Ø 0.144 in		Cable Through-hole	Station: HDE Tools: T470, T470S, T470F, T470M, T470Z, T470N
	<b>C470055</b>	Barrel Cartridge Ø 4 mm Ø 0.157 in		Cable Through-hole	Station: HDE Tools: T470, T470S, T470F, T470M, T470Z, T470N
	<b>C470030</b>	Barrel Cartridge Ø 5 mm Ø 0.197 in		Cable Through-hole	Station: HDE Tools: T470, T470S, T470F, T470M, T470Z, T470N

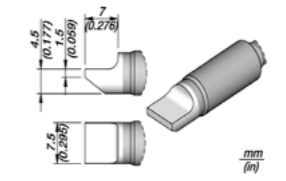
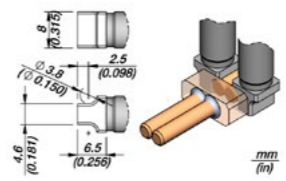

**C470 Cartridges Range for T470 HD Handles and HT470 HD Thermal Tweezers**

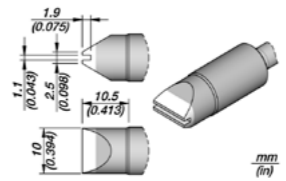
	Ref.	Description	Image and dimensions	Suggested components	Compatible with
	<b>C470049</b>	Barrel Cartridge Ø 5.2 mm Ø 0.205 in		Cable Through-hole	Station: HDE Tools: T470, T470S, T470F, T470M, T470Z, T470N
	<b>C470037</b>	Barrel Cartridge Ø 8 mm Ø 0.315 in		Cable Through-hole	Station: HDE Tools: T470, T470S, T470F, T470M, T470Z, T470N
	<b>C470041</b>	Barrel Cartridge Ø 12.5 mm Ø 0.492 in		Cable Through-hole	Station: HDE Tools: T470, T470S, T470F, T470M, T470Z, T470N
	<b>C470061</b>	Knife Cartridge 10.6 mm 0.417 in		Drag Soldering	Station: HDE Tools: T470, T470S, T470F, T470M, T470Z, T470N
	<b>C470064</b>	Blade Cartridge 10 mm 0.394 in		Pad cleaning Connector desoldering	Station: HDE Tools: T470, T470S, T470F, T470M, T470Z, T470N, HT470
	<b>C470059</b>	Blade Cartridge 20 mm 0.787 in		Pad cleaning Connector desoldering	Station: HDE Tools: T470, T470S, T470F, T470M, T470Z, T470N, HT470
	<b>C470023</b>	Blade Cartridge 32 mm 1.260 in		Pad cleaning Connector desoldering	Station: HDE Tools: T470, T470S, T470F, T470M, T470Z, T470N, HT470
	<b>C470063</b>	Blade Cartridge 37 mm 1.457 in		Pad cleaning Connector desoldering	Station: HDE Tools: T470, T470S, T470F, T470M, T470Z, T470N, HT470

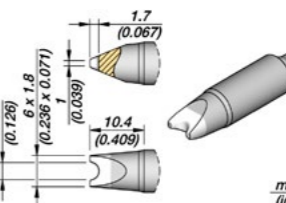
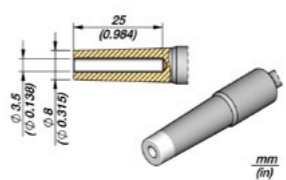
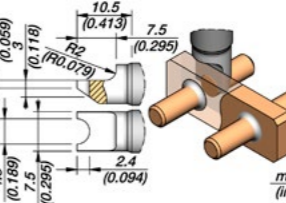
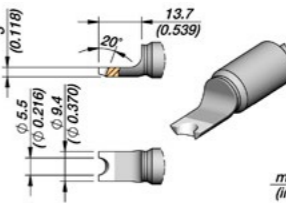
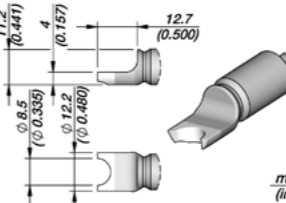

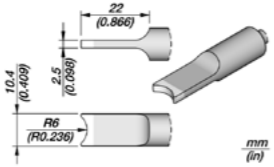
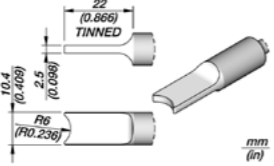
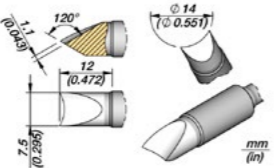
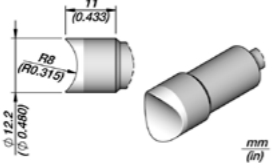
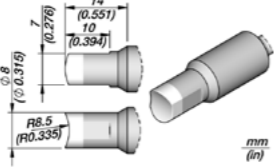
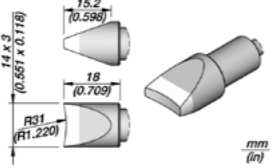

**C470 Cartridge Range for T470 HD Handles and HT470 HD Thermal Tweezers**

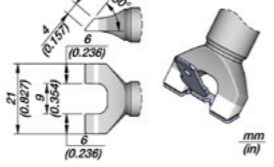
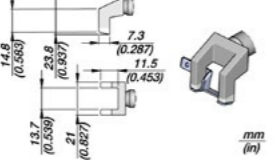
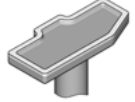
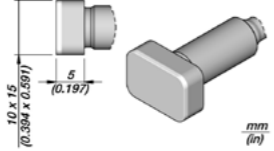
	Ref.	Description	Image and dimensions	Suggested components	Compatible with
	<b>C470046</b>	Single Flat Cartridge 7.5 mm 0.295 in		General use Sheet metal	Station: HDE Tools: T470, T470S, T470F, T470M, T470Z, T470N, HT470
	<b>C470050</b>	Blade Cartridge Ø 3.8 mm Ø 0.150 in		Cable Connectors	Station: HDE Tools: T470, T470S, T470F, T470M, T470Z, T470N, HT470
	<b>C470043</b>	Drag Cartridge 1.1 x 10 mm 0.043 x 0.394 in		Wire soldering	Station: HDE Tools: T470, T470S, T470F, T470M, T470Z, T470N
	<b>C470031</b>	Pin/Connector Cartridge Ø 3.3 mm Ø 0.126 in		Cable Through-hole	Station: HDE Tools: T470, T470S, T470F, T470M, T470Z, T470N
	<b>C470045</b>	Pin / Connector Cartridge Ø 3.5 mm Ø 0.138 in		Through-hole Male connector	Station: HDE Tools: T470, T470S, T470F, T470M, T470Z, T470N
	<b>C470042</b>	Pin/Connector Cartridge Ø 4.8 mm Ø 0.189 in		Cable Through-hole	Station: HDE Tools: T470, T470S, T470F, T470M, T470Z, T470N, HT470
	<b>C470066</b>	Pin/Connector Cartridge Ø 5.5 mm Ø 0.216 in		Cable Through-hole	Station: HDE Tools: T470, T470S, T470F, T470M, T470Z, T470N
	<b>C470065</b>	Pin/Connector Cartridge Ø 8.5 mm Ø 0.335 in		Cable Through-hole	Station: HDE Tools: T470, T470S, T470F, T470M, T470Z, T470N

**C470 Cartridge Range for T470 HD Handles and HT470 HD Thermal Tweezers**

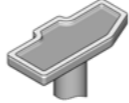
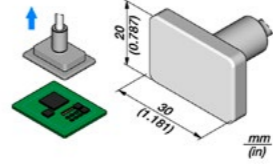
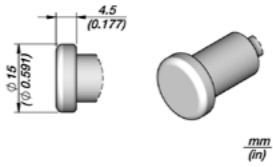
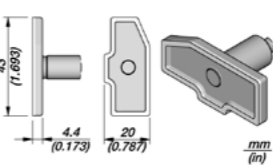
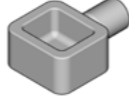
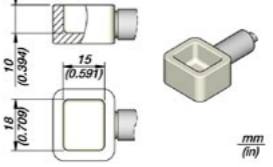
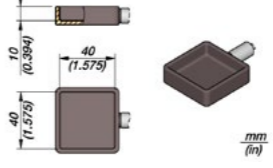
	Ref.	Description	Image and dimensions	Suggested components	Compatible with
	<b>C470012</b>	Pin/Connector Cartridge R. 6 mm S1 R. 0.236 in		Cables Connectors	Station: HDE Tools: T470, T470S, T470F, T470M, T470Z, T470N
	<b>C470038</b>	Pin/Connector Cartridge R. 6 mm S2 R. 0.236 in		Wide area Cables Connectors	Station: HDE Tools: T470, T470S, T470F, T470M, T470Z, T470N
	<b>C470047</b>	Pin/Connector Cartridge Ø 14 mm Ø 0.551 in		Cable Through-hole	Station: HDE Tools: T470, T470S, T470F, T470M, T470Z, T470N
	<b>C470010</b>	Pin/Connector Cartridge R. 8 mm R. 0.315 in		Cables connectors	Station: HDE Tools: T470, T470S, T470F, T470M, T470Z, T470N
	<b>C470052</b>	Pin/Connector Cartridge R. 8.5 mm R. 0.335 in		Cables connectors	Station: HDE Tools: T470, T470S, T470F, T470M, T470Z, T470N
	<b>C470029</b>	Pin/Connector Cartridge R. 31 mm R. 1.220 in		Connectors	Station: HDE Tools: T470, T470S, T470F, T470M, T470Z, T470N
	<b>C470051</b>	Faston Terminal Cartridge 21 mm 0.827 in		Connectors	Station: HDE Tools: T470, T470S, T470F, T470M, T470Z, T470N
	<b>C470070</b>	Faston Terminal Cartridge 21 mm 0.827 in		Connectors	Station: HDE Tools: T470, T470S, T470F, T470M, T470Z, T470N
	<b>C470044</b>	RF Shield Removal Cartridge 10 x 15 mm 0.394 x 0.591 in		Shield desoldering Metal PCB Sheet metal	Station: HDE Tools: T470, T470S, T470F, T470M, T470Z, T470N

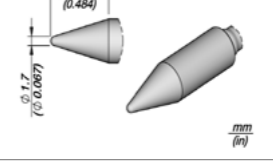
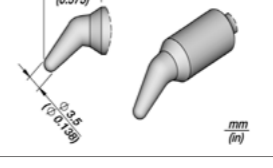
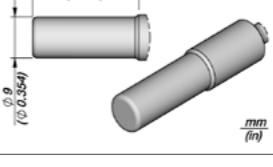
**C470 Cartridge Range for T470 HD Handles and HT470 HD Thermal Tweezers**

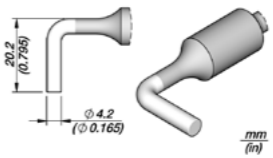
	Ref.	Description	Image and dimensions	Suggested components	Compatible with
	<b>C470057</b>	RF Shield Removal Cartridge 20 x 30 mm 0.787 x 1.181 in		Shield desoldering Metal PCB Sheet metal	Station: HDE Tools: T470, T470S, T470F, T470M, T470Z, T470N
	<b>C470005</b>	RF Shield Removal Cartridge Ø 15 mm Ø 0.591 in		Shield desoldering Metal PCB Sheet metal	Station: HDE Tools: T470, T470S, T470F, T470M, T470Z, T470N
	<b>C470027</b>	RF Shield Removal Cartridge 43 x 20 mm 1.693 x 0.787 in		Shield desoldering	Station: HDE Tools: T470, T470S, T470F, T470M, T470Z, T470N
	<b>C470SP01</b>	Solder Pot Cartridge 15 x 18 mm 0.591 x 0.709 in		Tinnig wires Desoldering Through-hole Multipin components	Station: HDE Tools: T470, T470S, T470F, T470M, T470Z, T470N
	<b>C470SP42</b>	Solder Pot Cartridge 40 x 40 mm 1.575 x 1.575 in		Tinnig wires Desoldering Through-hole Multipin components	Station: HDE Tools: T470, T470S, T470F, T470M, T470Z, T470N
	<b>C470025</b>	Heat Staking Cartridge Ø 1.7 mm Ø 0.067 in		Plastics	Station: HDE Tools: T470, T470S, T470F, T470M, T470Z, T470N
	<b>C470026</b>	Heat Staking Cartridge Ø 3.5 mm Ø 0.138 in		Plastics	Station: HDE Tools: T470, T470S, T470F, T470M, T470Z, T470N
	<b>C470032</b>	Heat Staking Cartridge Ø 9 mm Ø 0.354 in		Plastics	Station: HDE Tools: T470, T470S, T470F, T470M, T470Z, T470N
	<b>C470011</b>	Hook Cartridge Ø 4.2 mm Ø 0.165 in		Difficult to reach	Station: HDE Tools: T470, T470S, T470F, T470M, T470Z, T470N

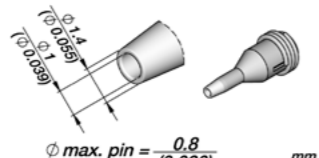

**C360 Tip Range for DS360 Micro Desoldering Iron**

	Ref.	Description	Image and dimensions	Suggested components	Compatible with
	<b>C360001</b>	Micro Desoldering Tip Ø 0.6 mm Ø 0.024 in		Through-hole Desoldering	Stations: CS, DI, DDE, DME Tool: DS360 Modules: MSE, MS
	<b>C360002</b>	Micro Desoldering Tip Ø 0.8 mm Ø 0.032 in		Through-hole Desoldering	Stations: CS, DI, DDE, DME Tool: DS360 Modules: MSE, MS
	<b>C360003</b>	Micro Desoldering Tip Ø 1 mm Ø 0.039 in		Through-hole Desoldering	Stations: CS, DI, DDE, DME Tool: DS360 Modules: MSE, MS
	<b>C360004</b>	Micro Desoldering Tip Ø 1.2 mm Ø 0.047 in		Through-hole Desoldering	Stations: CS, DI, DDE, DME Tool: DS360 Modules: MSE, MS
	<b>C360007</b>	Micro Desoldering Tip Ø 1.4 mm Ø 0.055 in		Through-hole Desoldering	Stations: CS, DI, DDE, DME Tool: DS360 Modules: MSE, MS
	<b>C360006</b>	Micro Desoldering Tip Ø 1.5 mm Ø 0.059 in		Through-hole Desoldering	Stations: CS, DI, DDE, DME Tool: DS360 Modules: MSE, MS
	<b>C360011</b>	Micro Desoldering Tip Ø 0.6 mm Pad Ø 0.024 in		Pad desoldering	Stations: CS, DI, DDE, DME Tool: DS360 Modules: MSE, MS

**C360 Tip Range for DS360 Micro Desoldering Iron**

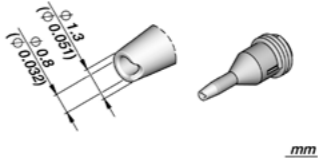
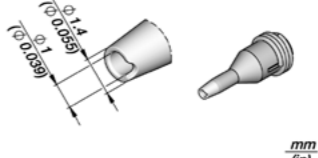
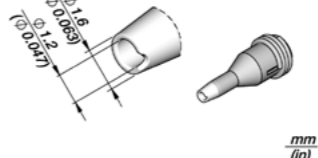
	Ref.	Description	Image and dimensions	Suggested components	Compatible with
	<b>C360012</b>	Micro Desoldering Tip Ø 0.8 mm Pad Ø 0.032 in		Pad desoldering	Stations: CS, DI, DDE, DME Tool: DS360 Modules: MSE, MS
	<b>C360013</b>	Micro Desoldering Tip Ø 1 mm Pad Ø 0.039 in		Pad desoldering	Stations: CS, DI, DDE, DME Tool: DS360 Modules: MSE, MS
	<b>C360014</b>	Micro Desoldering Tip Ø 1.2 mm Pad Ø 0.047 in		Pad desoldering	Stations: CS, DI, DDE, DME Tool: DS360 Modules: MSE, MS



**C560 Tip Range for DR560 Desoldering Iron**

Ref.	Description	Image and dimensions	Suggested components	Compatible with
<b>C560001</b>	Desoldering Tip Ø 0.6 mm HT Ø 0.024 in		Through-hole Desoldering	Stations: DI, DDE, DME Tool: DR560 Modules: MSE, MS
<b>C560014</b>	Desoldering Tip Ø 0.8 mm Ø 0.032 in		Through-hole Desoldering	Stations: DI, DDE, DME Tool: DR560 Modules: MSE, MS
<b>C560002</b>	Desoldering Tip Ø 0.8 mm HT Ø 0.032 in		Through-hole Desoldering	Stations: DI, DDE, DME Tool: DR560 Modules: MSE, MS
<b>C560003</b>	Desoldering Tip Ø 1 mm Ø 0.039 in		Through-hole Desoldering	Stations: DI, DDE, DME Tool: DR560 Modules: MSE, MS
<b>C560017</b>	Desoldering Tip Ø 1.1 mm Ø 0.043 in		Through-hole Desoldering	Stations: DI, DDE, DME Tool: DR560 Modules: MSE, MS
<b>C560004</b>	Desoldering Tip Ø 1.3 x Ø 3.2 mm Ø 0.052 x Ø 0.126 in		Through-hole Desoldering	Stations: DI, DDE, DME Tool: DR560 Modules: MSE, MS
<b>C560009</b>	Desoldering Tip Ø 1.3 x Ø 5 mm Ø 0.052 x Ø 0.197 in		Through-hole Desoldering	Stations: DI, DDE, DME Tool: DR560 Modules: MSE, MS

**C560 Tip Range for DR560 Desoldering Iron**

Ref.	Description	Image and dimensions	Suggested components	Compatible with
<b>C560005</b>	Desoldering Tip Ø 1.5 mm Ø 0.059 in		Through-hole Desoldering	Stations: DI, DDE, DME Tool: DR560 Modules: MSE, MS
<b>C560006</b>	Desoldering Tip Ø 1.9 mm Ø 0.075 in		Through-hole Desoldering	Stations: DI, DDE, DME Tool: DR560 Modules: MSE, MS
<b>C560018</b>	Desoldering Tip Ø 2.2 mm Ø 0.087 in		Through-hole Desoldering	Stations: DI, DDE, DME Tool: DR560 Modules: MSE, MS
<b>C560007</b>	Desoldering Tip Ø 2.4 mm Ø 0.095 in		Through-hole Desoldering	Stations: DI, DDE, DME Tool: DR560 Modules: MSE, MS
<b>C560015</b>	Desoldering Tip Ø 3 mm Ø 0.118 in		Through-hole Desoldering	Stations: DI, DDE, DME Tool: DR560 Modules: MSE, MS
<b>C560011</b>	Desoldering Tip Ø 0.6 mm HT Pad Ø 0.024 in		Pad desoldering	Stations: DI, DDE, DME Tool: DR560 Modules: MSE, MS
<b>C560012</b>	Desoldering Tip Ø 0.8 mm HT Pad Ø 0.032 in		Pad desoldering	Stations: DI, DDE, DME Tool: DR560 Modules: MSE, MS
<b>C560013</b>	Desoldering Tip Ø 1 mm Pad Ø 0.039 in		Pad desoldering	Stations: DI, DDE, DME Tool: DR560 Modules: MSE, MS





**W140 Blade Cartridge Range**  
for **WS140** High-Temperature Precision  
Wire Stripper Tweezers

	Ref.	Description	Image and dimensions	Suggested components	Compatible with	
	<b>W14003F</b>	Flat Blade Cartridges 3 mm 0.118 in		Wire insulation stripping	Station: WSS Tool: WS140	
	<b>W14005F</b>	Flat Blade Cartridges 5 mm 0.197 in		Wire insulation stripping	Station: WSS Tool: WS140	
	<b>W14012F</b>	Flat Blade Cartridges 12 mm 0.472 in		Wire insulation stripping	Station: WSS Tool: WS140	
	<b>W14014G</b>	Single-Hole Cartridges Solid Wire 14 AWG		Wire insulation stripping	Station: WSS Tool: WS140	
	<b>W14016G</b>	Single-Hole Cartridges Solid Wire 16 AWG		Wire insulation stripping	Station: WSS Tool: WS140	
	<b>W14018G</b>	Single-Hole Cartridges Solid Wire 18 AWG		Wire insulation stripping	Station: WSS Tool: WS140	
	<b>W14020G</b>	Single-Hole Cartridges Solid Wire 20 AWG		Wire insulation stripping	Station: WSS Tool: WS140	
	<b>W14022G</b>	Single-Hole Cartridges Solid Wire 22 AWG		Wire insulation stripping	Station: WSS Tool: WS140	
			Single-Hole Cartridges Solid Wire 24 AWG		Wire insulation stripping	Station: WSS Tool: WS140
			Single-Hole Cartridges Solid Wire 26 AWG		Wire insulation stripping	Station: WSS Tool: WS140
			Single-Hole Cartridges Solid Wire 28 AWG		Wire insulation stripping	Station: WSS Tool: WS140

**W140 Blade Cartridge Range** for **WS140** High-Temperature Precision Wire Stripper Tweezers

	Ref.	Description	Image and dimensions	Suggested components	Compatible with
	<b>W14024G</b>	Single-Hole Cartridges Solid Wire 24 AWG		Wire insulation stripping	Station: WSS Tool: WS140
	<b>W14026G</b>	Single-Hole Cartridges Solid Wire 26 AWG		Wire insulation stripping	Station: WSS Tool: WS140
	<b>W14028G</b>	Single-Hole Cartridges Solid Wire 28 AWG		Wire insulation stripping	Station: WSS Tool: WS140
	<b>W14030G</b>	Single-Hole Cartridges Solid Wire 30 AWG		Wire insulation stripping	Station: WSS Tool: WS140
	<b>W14032G</b>	Single-Hole Cartridges Solid Wire 32 AWG		Wire insulation stripping	Station: WSS Tool: WS140
	<b>W14034G</b>	Single-Hole Cartridges Solid Wire 34 AWG		Wire insulation stripping	Station: WSS Tool: WS140
	<b>W14036G</b>	Single-Hole Cartridges Solid Wire 36 AWG		Wire insulation stripping	Station: WSS Tool: WS140
	<b>W14037G</b>	Single-Hole Cartridges Solid Wire 37 AWG		Wire insulation stripping	Station: WSS Tool: WS140
	<b>W14038G</b>	Single-Hole Cartridges Solid Wire 38 AWG		Wire insulation stripping	Station: WSS Tool: WS140
	<b>W14040G</b>	Single-Hole Cartridges Solid Wire 40 AWG		Wire insulation stripping	Station: WSS Tool: WS140



**ESD** safe

  
[www.jbctools.com](http://www.jbctools.com)



0032455/0524