

JBC

www.jbctools.com

INSTRUCTION MANUAL



2 Tools DDE Station with Pneumatic Pump

Ref. DDVE-QC

Packing List

The following items should be included:

DDE Control Unit 1 unit
 Ref. DDE-1C (120V)
 DDE-2C (230V)
 DDE-9C (100V)



Pneumatic Desoldering Module 1 unit
 Ref. MVE-A



ESD Tip Cleaner 1 unit
 Ref. CL8499



General Purpose Handle 1 unit
 Ref. T245-A



Stand 1 unit
 Ref. AD-SE



Desoldering Iron 1 unit
 Ref. DR560-A



Stand 1 unit
 Ref. DR-SE



Sponge 1 unit
 Ref. S0354



Metal Brush 1 unit
 Ref. CL6217



Brass Wool 1 unit
 Ref. CL6210



Cartridge holder 1 unit
 Ref. 0021083



Stand Cable 2 units
 Ref. 0011283



Module Cable 1 unit
 Ref. 0014874



Power cord 1 unit
 Ref. 0010569 (230V)
 0013671 (100/120V)



DR560 Accessories

Ref. 0022819

Tip cleaning set 1 unit
Ref. 0965970



Long Tip Cleaning set 1 unit
Ref. 0965760



Glass solder collector1 unit
Ref. 0812620



Spanner 1 unit
Ref. 0780550



Filter Box 1 unit
Ref. 0780840
It contains 10 filters



Internal gasket 1 unit
Ref. 0019208
It contains 2 gaskets



Metal solder collector 1 unit
Ref. 0812630



Union Flanges 1 unit
Ref. 0011356



Filter Box1 unit
Ref. 0005966
It contains 50 filters



Cleaning stick1 unit
Ref. 0786640



Venturi Filter1 unit
Ref. 0008446



Cotton Filter 1 unit
Ref. 0781046
It contains 10 filters



Suction Filter 1 unit
Ref. 0821830



Manual 1 unit
Ref. 0023125

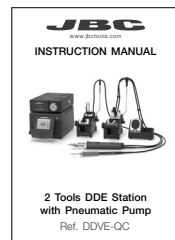

Features

Work simultaneously with **up to 2 tools** and join each station port with **1 module** + 1 pedal (Peripherals).

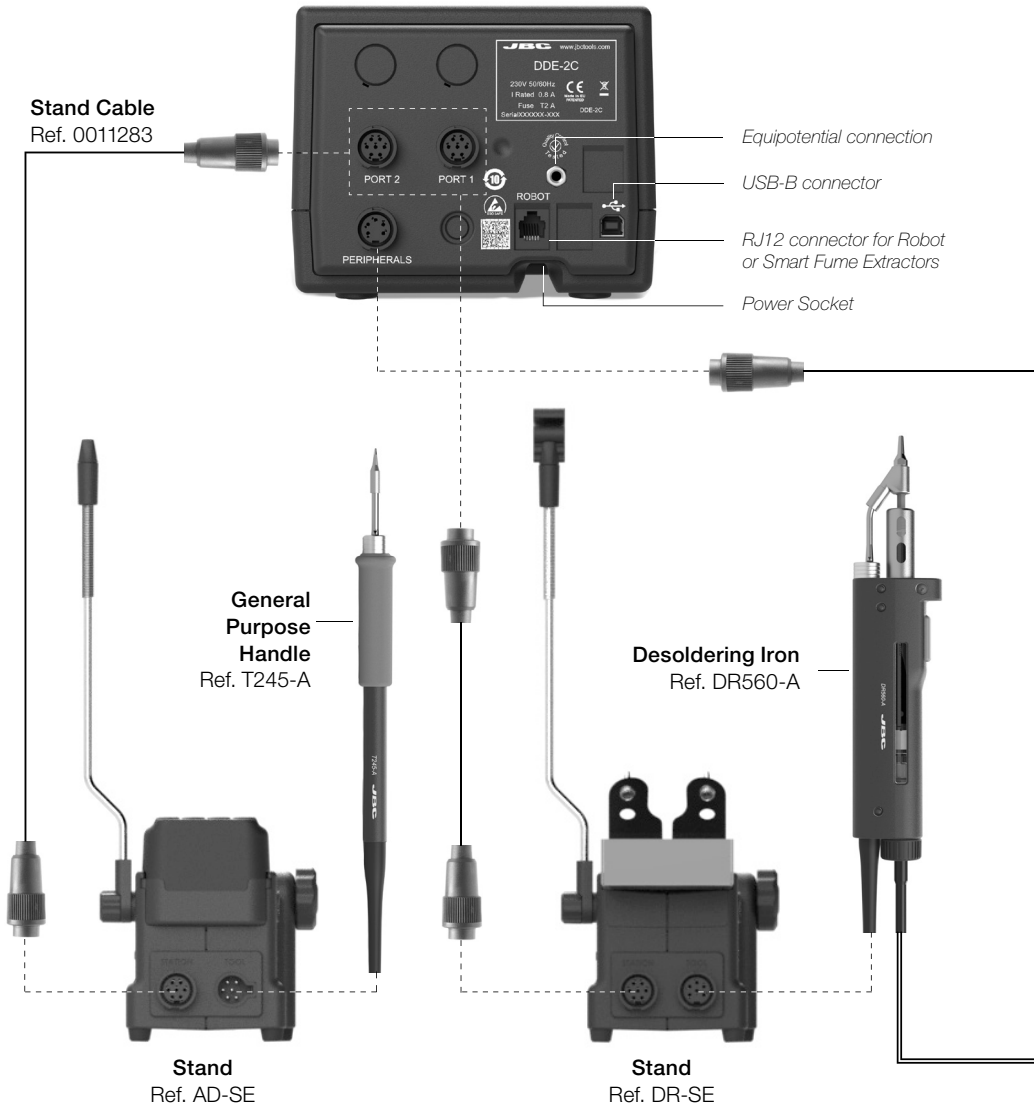



Module Cable
Ref. 0014874

Pneumatic Desoldering Module
Ref. MVE-A

To another peripheral

To Pedal
Ref. P-005

Suction Filter
Ref. 0821830

Air pressure (4-6 bar)
Tubing $\varnothing 4 \times \varnothing 6$ mm
(Not supplied)

Work Screen

The DDE offers an intuitive user interface which provides quick access to station parameters.

Default PIN: 0105

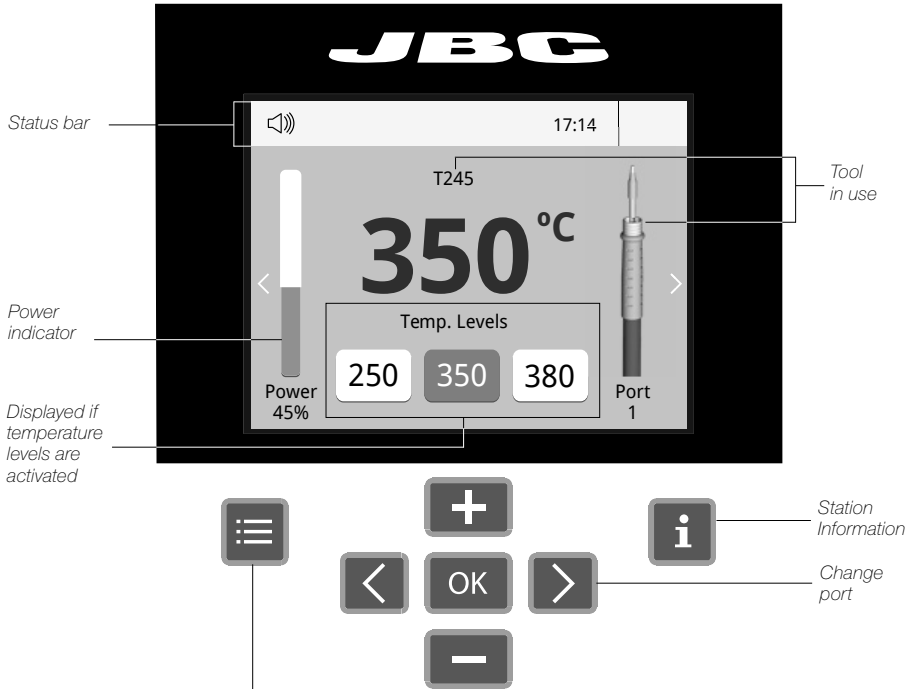

Menu Options



Set the station parameters

Station

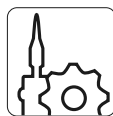

Set the tool parameters

Tools



Display the hours worked in each cycle

Counters



Consult / modify the links of the peripherals connected to the station with the port they are connected to.

Peripherals



It is possible to choose the language from a list.

Language



Allows you to carry out an overall station reset restoring all the parameters to their default values.

Reset

Advanced functionalities



Graphics

It provides detailed graphics of tip temperature and power delivery in real time during solder joint formation for analysis purposes. This helps you decide how to adjust your process or which tip to use to obtain the best quality soldering.



Profiles

Designed to avoid thermal shock when soldering Ceramic Chip components like MLCC, this new and unique feature allows controlling the heating ramp up rate of the tool to gradually increase the temperature of the component through all the phases of the soldering process. Up to 25 fully configurable soldering profiles can be stored.

JBC Net

The first system to optimize traceability in soldering

- Get greater quality and control in your production
- Manage your whole soldering process remotely in real time

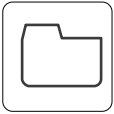

Files

Export graphics

Insert a USB flash drive into the USB-A connector to save your soldering process in csv format.



Update

Station update

Download the JBC Update File from www.jbctools.com/software.html
Insert the USB flash drive with the file downloaded to the station.



System notifications

The following icons will be displayed on the screen's status bar.



USB flash drive is connected.



Station is controlled by a PC.



Station is controlled by a robot.



Station software update.
Press INFO to start the process.



Warning.
Press INFO for failure description.



Error.
Press INFO for failure description, the type of error and how to proceed.

MVE Initial Set up

1. After connecting the module, enter the Peripherals Menu and select the port which you want to join with the module.
2. Select the module from the list of peripheral connections. Remember your first connection is denoted as "a", the second being "b", etc. (e.g. MV_a, MV_b,...).
3. Press Menu or Back to save changes.

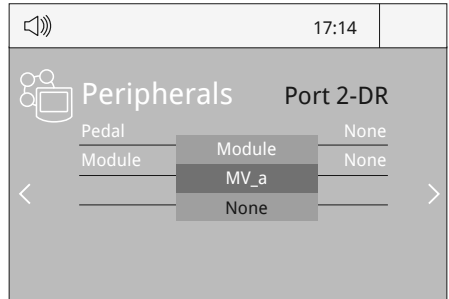

Pedal Initial Set up*

1. Enter the **Peripherals** Menu and **select the port** which you want to join to the pedal.

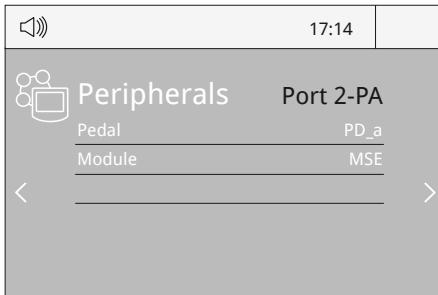

2. Select the pedal from the list (*Note that your first connection is denoted as "a", the second being "b", etc. (e.g. PD_a, PD_b,...).*)

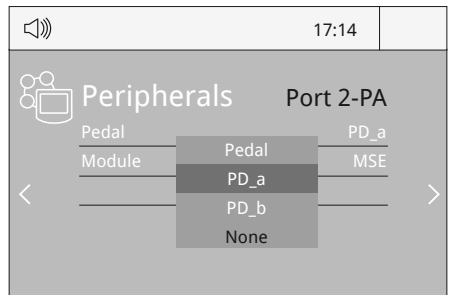

3. Set the pedal function according to your work needs:

Select how the pedal acts: as **Sleep**, **Extractor** (hibernation) or as a **module** switch.

Select the activating mode of the pedal (**pressed/released**)

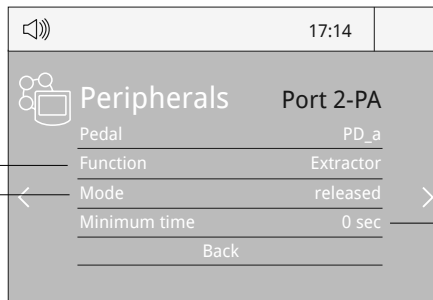

Set the duration of the activation time when pressing the pedal **once****. For continuous functioning keep the pedal pressed.

*Ref. P-005 (Not included)

**NB: The same can be applied inversely when continually pressing the pedal and releasing to activate.

Operation

The JBC Most Efficient Soldering System

Our revolutionary technology is able to recover tip temperature extremely quickly. It means the user can work at a lower temperature and improve the quality of soldering. The tip temperature is further reduced thanks to the Sleep and Hibernation modes which increase up to 5 times the life of the tip.

1. Work

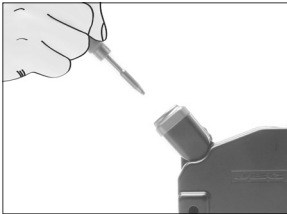

When the tool is lifted from the stand the tip will heat up to the selected temperature.

2. Sleep

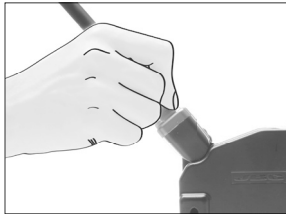

When the tool is in the stand, the temperature falls to the preset Sleep temperature.

3. Hibernation

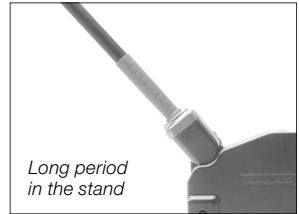

After longer periods of inactivity, the power is cut off and the tool cools down to room temperature.

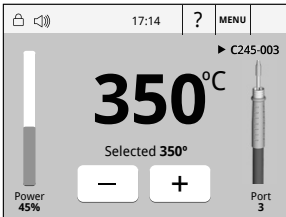

Tools Menu:

- Adjust temperature limits and cartridge.
- Set temperature levels.

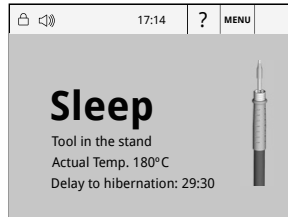

Tools Menu:

- Set Sleep temperature.
- Set Sleep delay. (from 0 to 9 min or no Sleep)



Tools Menu:

- Set Hibernation delay. (from 0 to 60 min or no hibernation)

Desoldering process

Use a tip with a larger diameter than the pad to achieve maximum aspiration and thermal efficiency.

1. Placing

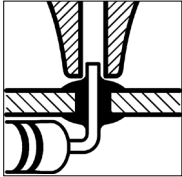

Place the tip over the lead.

2. Rotating

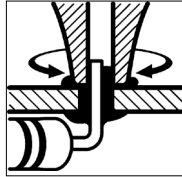

When the solder melts, gently move the tip in a circular motion.

3. Aspirating



Press and hold the tool button to start the suction and continue the movement completing 3 or 4 circles.

4. Removing

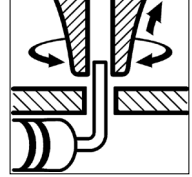

Remove the tip while maintaining the suction to make sure all the solder is removed from the joint.

If any solder remains are left on a terminal after desoldering it, resolder it with fresh solder and repeat the desoldering operation.

If desoldering tips does not provide enough heat to desolder leads from ground planes, consider using a preheater PCB.

Quick Tip Changer

Save time and change cartridges safely without switching the station off. Be careful, the cartridges may be hot, when placing them in the storage rack.

1. Removing



Place the cartridge in the extractor and pull the handle to remove it.

2. Inserting



Place the handle on top of the new cartridge and press down.

3. Fixing

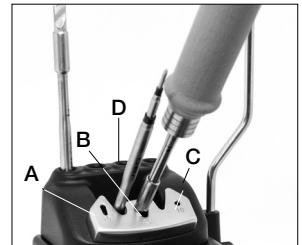

Use the holes to fix the cartridge as follows:

- A. For curved C210
- B. For C245
- C. For straight C210
- D. cartridge Storage rack

Important: It is essential to insert the cartridge as far as the mark for a proper connection.



DR560 Changing Tips

1. Removing

Unscrew the tip using the spanner supplied.

2. Inserting

Fit the new tip and tighten with the spanner to make sure it is air tight.

The DR560 uses C560 tips.

Find the model that best suits your soldering needs in www.jbctools.com

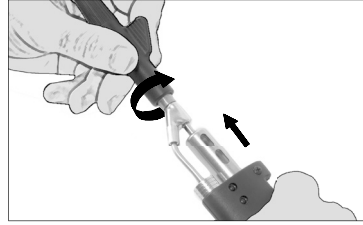

Glass Solder Collector Cleaning

1. Removing the lid

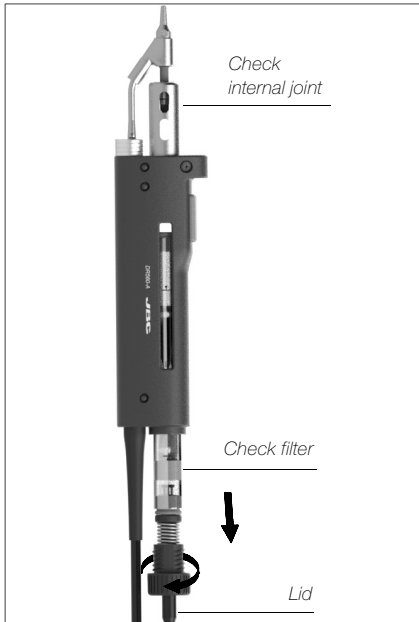

The lid must be unscrewed with the DR560 in a vertical position.

3. Inserting the glass solder collector

The glass solder collector must be inserted with coil filter in place, positioned between the 2 lines marked. Then the whole unit must be closed by screwing the lid.

2. Cleaning



Remove the coil and clean the inside of the glass solder collector with the cleaning stick.

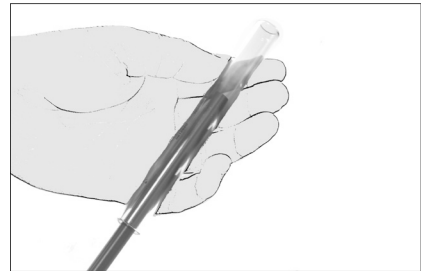

Check the filter and replace it if it is dirty or damaged.



DR560 Maintenance

Tip Care

The intake tube should be periodically cleaned with the largest rod possible.

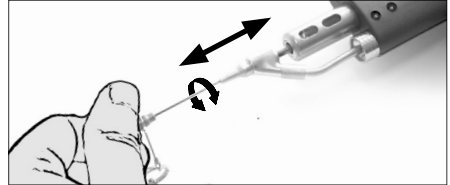
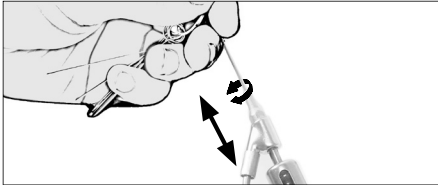

Important

DO NOT press the vacuum pump button while tinning the desoldering tip, as the fumes given off by the flux would quickly block the ducts and the air filter.

MVE Changing filters

- Keep the casing clean by using a damp cloth. Periodically check all cable and tube connections.
- Keep filters clean to ensure proper solder suction and replace them when necessary.

Important

Do not use sharp pointed objects to open the suction filter.

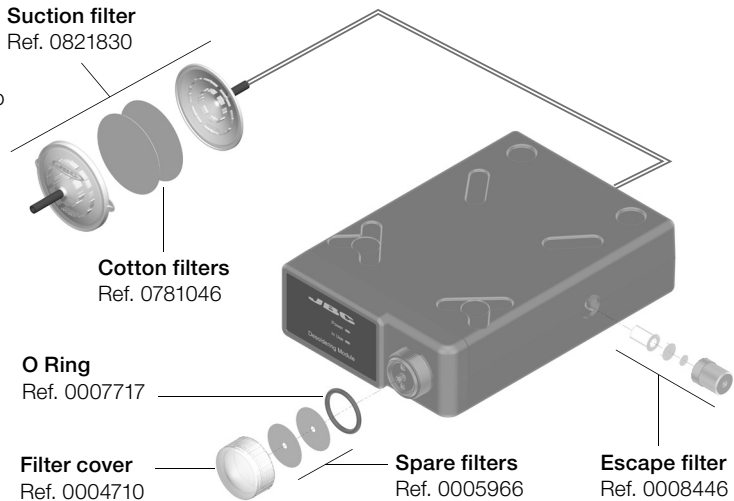

Removing the pneumatic tubing

Push the release ring to remove the pneumatic tubing.



Tip Cleaner

Improve thermal transfer by cleaning the tip after each solder joint.

Brass wool

Ref. CL6210

Very effective cleaning method. It leaves a small layer of solder on the tip to prevent oxidation between cleaning and reflowing.

Splashguard

Ref. 0017576

It prevents splashing of solder particles when using the brass wool.

Antisplash Membrane

Ref. 0017574

Prevents splashing to maintain the work area clean.

ESD Tip Wiper

Ref. CL0240

A temperature resistant receptacle lets the operator remove excess solder by gentle tapping or wiping.

Sponge

Ref. S0354

The least harmful cleaning method. Keep the sponge damp with distilled water when working to avoid tip wear.

Non-slip base

No need to hold the base while cleaning tips.



Tapping:

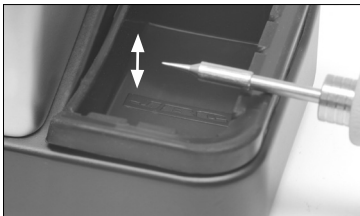

Tap to remove excess solder.

Wiping:



Use the slots to remove remaining particles.

DDE-C Compatibility

Basic working system				Peripherals			
Control Unit	Stand	Tool	Cartridge Range	MSE-A / MVE-A	MNE-A	FSE-A	P-005
DDE-C	AD-SE	T210-A	C210			●	●
		T245-A	C245			●	●
	DN-SE	T210-NA*	C210		●		●
		T245-NA*	C245				
	AP-SE	AP250-A	C250				●
	PA-SE	PA120-A	C120				●
	HT-SE	HT420-A	C420			●	●
	DS-SE	DS360-A	C360	●		●	●
	DR-SE	DR560-A	C560	●		●	●

* The MNE Nitrogen Flow Regulator is required.

MVE-A Compatibility

Module	Stand	Tool	Cartridge Range	Control Units		Peripherals
				DDE	DME	P-005
MVE-A	DS-SE	DS360-A	C360	●	●	●
	DR-SE	DR560-A	C560	●	●	●

Maintenance

Before carrying out maintenance or storage, always allow the equipment to cool.

- Clean the station screen with a glass cleaner or a damp cloth.
- Use a damp cloth to clean the casing and the tool. Alcohol can only be used to clean the metal parts.
- Periodically check that the metal parts of the tool and stand are clean so that the station can detect the tool status.
- Maintain tip surface clean and tinned prior to storage in order to avoid tip oxidation. Rusty and dirty surfaces reduce heat transfer to the solder joint.
- Periodically check all cables and tubes.
- Replace a blown fuse as follows:

Clean periodically

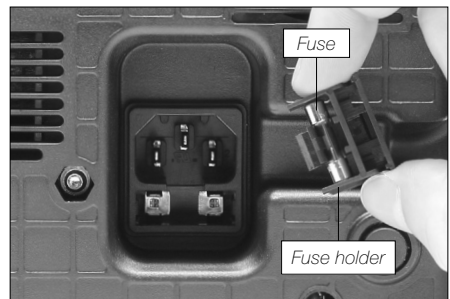
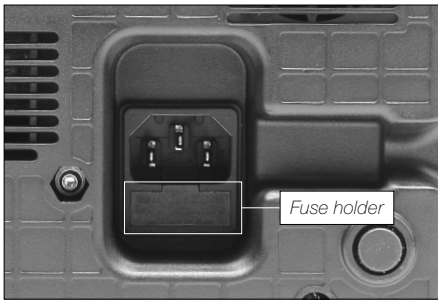
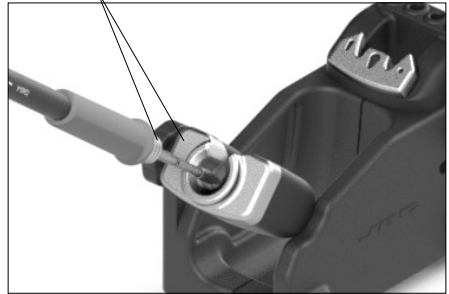

1. Pull off the fuse holder and remove the fuse. If necessary use a tool to lever it off.

2. Press the new fuse into the fuse holder and replace it in the station.

- Replace any defective or damaged pieces. Use original JBC spare parts only.
- Repairs should only be performed by a JBC authorized technical service.

Safety



It is imperative to follow safety guidelines to prevent electric shock, injury, fire or explosion.

- Do not use the units for any purpose other than soldering or rework. Incorrect use may cause fire.
- The power cord must be plugged into approved bases. Be sure that it is properly grounded before use. When unplugging it, hold the plug, not the wire.
- Do not work on electrically live parts.
- The tool should be placed in the stand when not in use in order to activate the sleep mode. The soldering tip, the metal part of the tool and the stand may still be hot even when the station is turned off. Handle with care, including when adjusting the stand position.
- Do not leave the appliance unattended when it is on.
- Do not cover the ventilation grills. Heat can cause inflammable products to ignite.
- Avoid flux coming into contact with skin or eyes to prevent irritation.
- Be careful with the fumes produced when soldering.
- Keep your workplace clean and tidy. Wear appropriate protective glasses and gloves when working to avoid personal harm.
- Utmost care must be taken with liquid tin waste which can cause burns.
- This appliance can be used by children over the age of eight and also persons with reduced physical, sensory or mental capabilities or lack of experience provided that they have been given adequate supervision or instruction concerning use of the appliance and understand the hazards involved. Children must not play with the appliance.
- Maintenance must not be carried out by children unless supervised.

有害物质含量表

产品中有害物质的名称及含量

部件名称	有害物质					
	铅(Pb)	汞(Hg)	镉(Cd)	六价铬 (Cr(VI))	多溴联苯 (PBB)	多溴二苯醚 (PBDE)
烙铁头	○	○	○	○	○	○
手柄	○	○	○	○	○	○
电源线	○	○	○	○	○	○
主机	○	○	○	○	○	○
电源插座	○	○	○	○	○	○
保险丝	○	○	○	○	○	○
主开关	○	○	○	○	○	○
电位连接	X	○	○	○	○	○
变压器	○	○	○	○	○	○
线路板	X	○	○	○	○	○

○ 表示该有害物质在该部件所有均质材料中的含量均在GB/T 26572 规定的限量要求以下。
 X 表示该有害物质至少在该部件的某一均质材料中的含量超出GB/T 26572 规定的限量要求。

Specifications

2 Tools DDE Station with Pneumatic Pump

DDVE-1QA / DDVE-2QA / DDVE-9QA

DDE-1A 120V 50/60Hz. Input fuse:	4A. Output: 23.5V
DDE-2A 230V 50/60Hz. Input fuse:	2A. Output: 23.5V
DDE-9A 100V 50/60Hz. Input fuse:	5A. Output: 23.5V
- Temperature Range:	90 - 450 °C (190 - 840 °F)
- Idle Temp. Stability (still air):	±1.5 °C (±3 °F)
- Output Peak Power:	150W per tool
- Tip to ground resistance:	<2 ohms
- Tip to ground voltage:	<2mV RMS
- Ambient Operating Temperature:	10 - 50 °C (50 - 122 °F)
- Communicatio connectors:	USB-A / USB-B / Peripherals connectors
- Robot connector:	RJ12 for RS-232 protocol
- Control Unit Weight:	3,815 kg (8.41 lb)
- Control Unit Dimensions:	148 x 120 x 232 mm (5.83 x 4.72 x 9.13 in)

MVE-A

- Ambient Operating Temperature:	10 - 50 °C (50 - 122 °F)
- Vacuum at 6 Bar:	90% / 680 mmHg / 26.8 inHg
- Flow rate:	15 SLPM
- Peripheral Weight:	0,7 kg (1.54 lb)
- Peripheral Dimensions:	145 x 55 x 225 mm (5.71 x 2.17 x 8.86 in)
- Pedal connection	
- Total Package:	368 x 474 x 195 mm / 9.25 kg 14.5 x 18.7 x 7.7 in / 24.49 lb

Complies with CE standards.
ESD protected.

JBC

Warranty

JBC's 2 year warranty covers this equipment against all manufacturing defects, including the replacement of defective parts and labour. Warranty does not cover product wear or misuse. In order for the warranty to be valid, equipment must be returned, postage paid, to the dealer where it was purchased.

Please register your product warranty within 30 days of purchase in:
www.jbctools.com/productregistration.



This product should not be thrown in the garbage.

In accordance with the European directive 2002/96/EC, electronic equipment at the end of its life must be collected and returned to an authorized recycling facility.



www.jbctools.com