

JBC

www.jbctools.com

INSTRUCTION MANUAL

	Page
中文	2
English	22



精密焊接台

Ref. CD-2SHE

产品描述

需包含以下部件:

CD 控制主机 1 件
Ref. CD-2HE (230V)



精确用途手柄 1 件
Ref. T210-A



电源线 1 件
Ref. 0009401 (230V)



烙铁头 2 件
Ref. C210001 (x1)
C210008 (x1)



铜丝球 1 件
Ref. CL6210

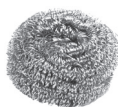

海绵 1 件
Ref. S0354



说明书 1 件
Ref. 0017070



产品特性



可调式支架

调节工具支架，满足工作位置需求。

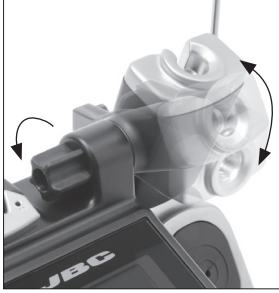

集线器 (Ref. CC3702)

将电线放置在集线器上，避免工作位置受到电线干扰。

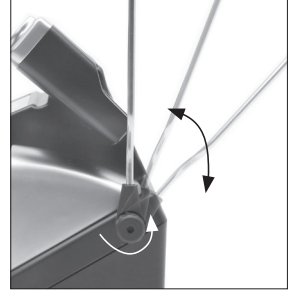
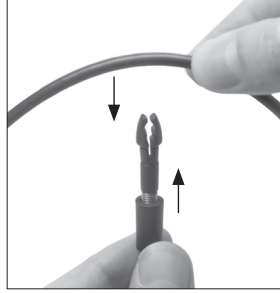

焊嘴清洁系统

选择最适合您的焊接清洁需求的选择。

防溅罩

Ref. 0017576

可防止在使用铜丝清洁球的时候残锡的飞溅。

防溅层

Ref. 0017574

防止溅锡确保工作环境的整洁。

铜丝球

Ref. CL6210

有效清洁方法。在清洁后到下次焊接前对焊嘴加锡保养，以防焊嘴氧化。

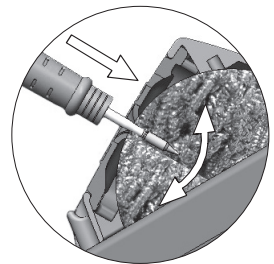

如果烙铁头非常脏，建议先刮掉多余的锡。

擦板

Ref. CL0160

耐高温凹槽可以让操作者通过轻轻拍打或擦拭去除多余的焊锡。

如果需要拆下保护罩，请按照以下步骤进行：

1. 松开保护罩扣锁。



2. 撤走保护罩。

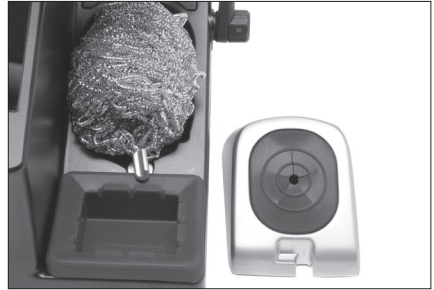

其他防溅罩选项 (不包括)：

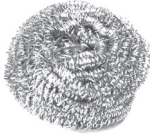

不锈钢丝球
Ref. CL6205
为焊嘴提供更深层的
清洁



金属刷
Ref. CL6220
如果使用得当，
可提供更彻底的清洁。

擦板

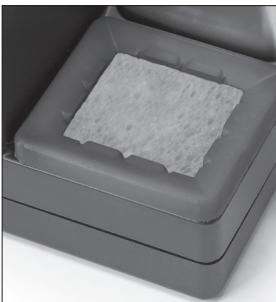

海绵

Ref. S0354

最温和的清洁方法。

工作时用蒸馏水润湿海绵避免焊嘴磨损。

敲击

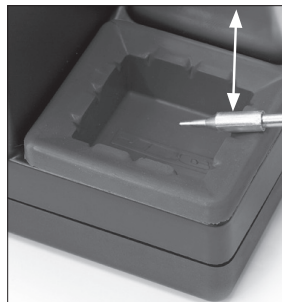

轻轻敲击除去多余的残锡。

擦拭

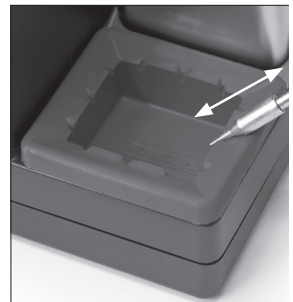

使用槽口擦拭任何残留的锡粒。

兼容手柄

普通用途

与 C245 烙铁头系列兼容

带有柔软隔热层的普通用途手柄

Ref. T245-A

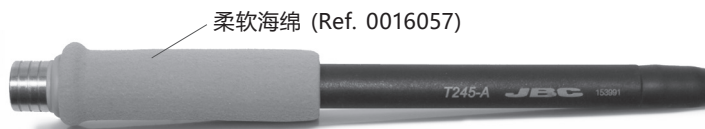

蓝色普通用途手柄

Ref.T245-PA

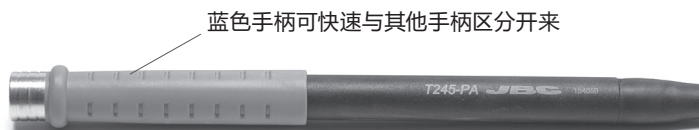

防滑手柄

Ref.T245-B



使用滑动标签可轻松更换T245-A / T245-C握套 (型号 0016057 共四个握套)。

1. 插入标签

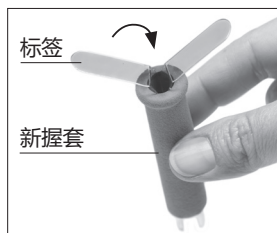

将滑动标签插入新握套内。

2. 套上手柄

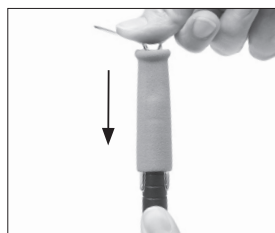

顺着标签将握套套上手柄。

3. 移去标签

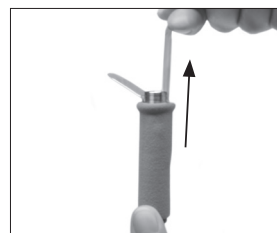

要移去标签，握住手柄并向外拉。

注意:所有型号都配有1.5米电线。

用于精确操作

与 C210 烙铁头系列兼容

精确用途手柄

Ref.T210-A



蓝色精确手柄

Ref.T210-PA



蓝色手柄可快速与其他手柄区分开来

更高要求

重要:仅与 C245 焊头兼容于 CD 台。

高精度焊接工作需要持续的高导热。它们提供良好的隔热条件，其中还有一个螺丝固定住烙铁头以防止打滑。

普通用途HD手柄

Ref.T470-A



普通用途HD手柄，带3米电线

Ref.T470-SA

三叶型手柄

Ref.T470-ZA

更好地握持工具。



隔热HD手柄

Ref.T470-FA

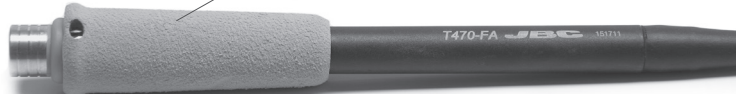

隔热HD手柄，带3米电线

Ref.T470-MA

海绵

注意:所有型号都配有1.5米电线，配有3米电线的型号除外。

快速烙铁头更换器

节省时间, 安全更换烙铁头, 主机无需断电。

1. 移除

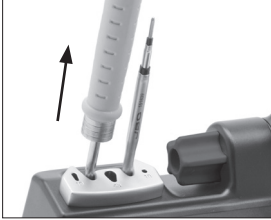

将手柄放置在插拔座上, 拔出烙铁头。

2. 插入



将手柄置在新烙铁头顶端, 轻轻下压。

3. 固定

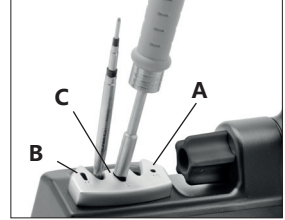

使用孔洞来固定烙铁头*, 操作如下:

- A. 直线型烙铁头 C210.
- B. 弯曲型烙铁头 C210.
- C. C245.

*重要

切记尽量将烙铁头插入到标识处, 以确保正确的连接。

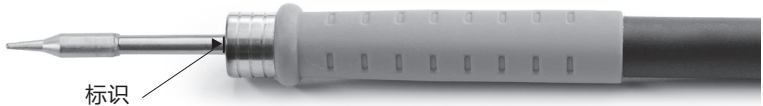

兼容烙铁头

CD 主机 使用C245 烙铁头及 T245/T470 手柄或 C210 烙铁头及 T210 手柄。找到最适合你的焊接需求的款式, 请登录 www.jbctools.com

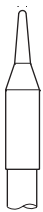

圆头



凿形



圆形弯曲



斜角

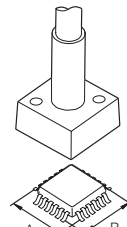

特殊型号

USB 接口

自我们官网下载最新软件, 确保您的焊台处于最佳状态。

JBC 更新程序 (JBC Updater)

www.jbctools.com/software.html

通过USB接口更新软件。

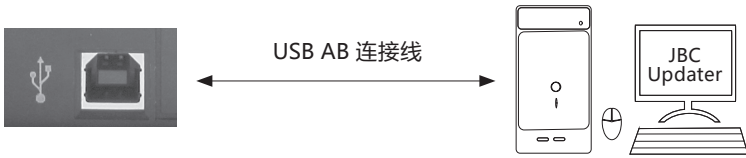

JBC 管理员 (JBC Manager)

www.jbctools.com/manager.html

通过该程序使用电脑管理和跟踪多台焊台。可将数据导出到其他电脑上。

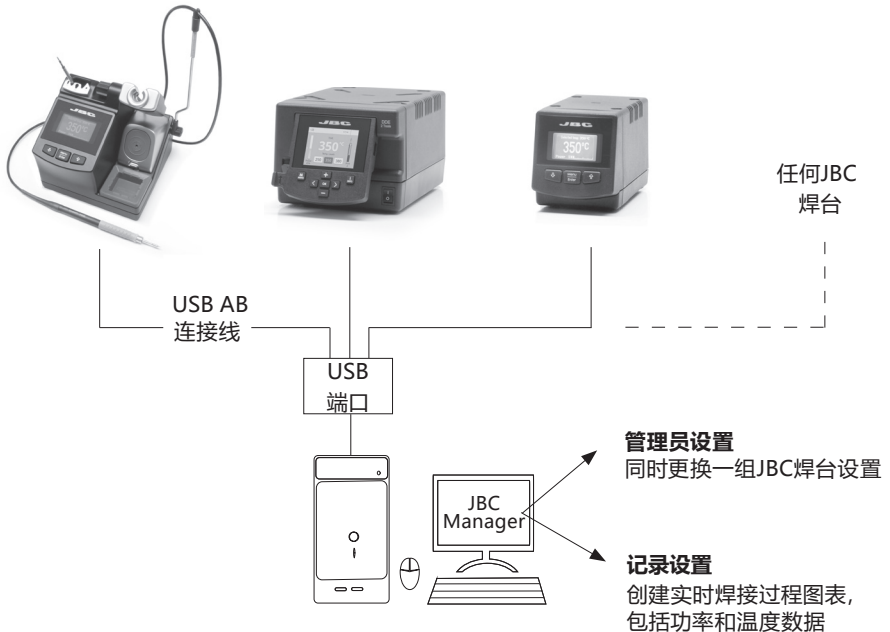

操作

JBC 专属加热系统

革命性技术, 可以令烙铁头温度快速回升。
这意味着用户可以在较低温度下操作, 并提高焊接质量。
之后, 烙铁头温度在睡眠和休眠模式下降低, 可令其寿命延长五倍。

1. 工作



当工具从支架下取下时, 烙铁头温度会加热到选定温度。

2. 睡眠 (Sleep)



当工具放置在支架上时, 温度会下降到预置睡眠温度。

3. 休眠 (Hibernation)



长时间没有使用后, 电源会切断, 工具会冷却到室温。

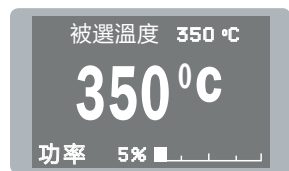

- 更改温度 (自 90 至 450°C)
- 选择温度等级
- 固定一个温度



- 设置睡眠温度
- 设置睡眠延迟 (从 0 到 9 分钟或永不睡眠)



- 设置休眠延迟 (从 0 到 35 分钟或永不休眠)

流程控制

工作屏

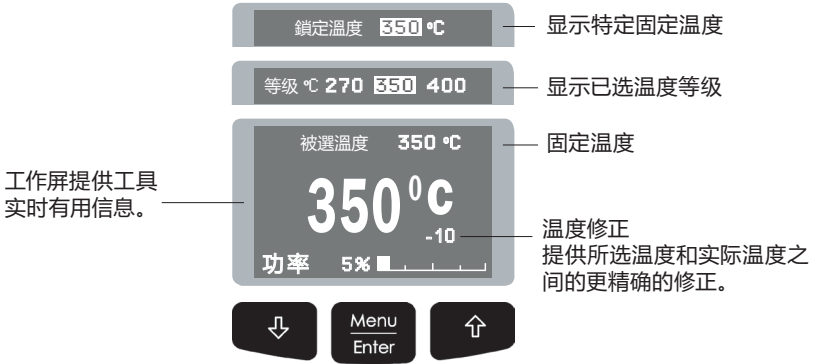

菜单屏

原始密码: 0105

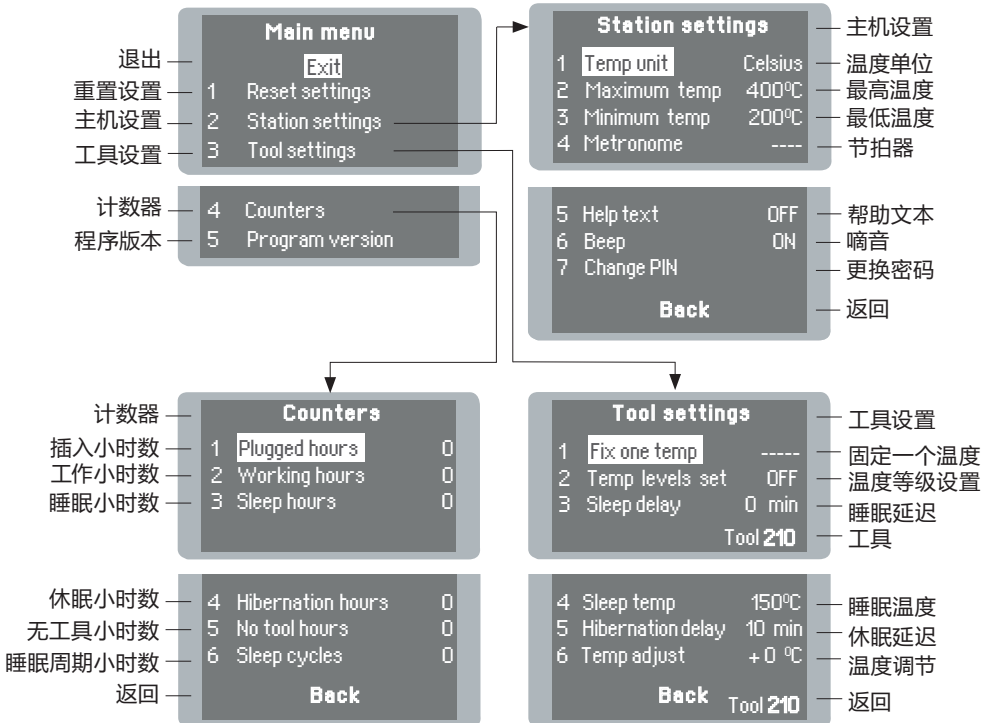

参数

请注意如果这些参数使用不当可能会导致焊嘴寿命的减少。请遵循推荐的准则：

主机设置

参数描述	建议	警告
温度单位 摄氏度 (°C)或者华氏度(°F)	不适用	
最高温度 设定进行工作的最高温度。 默认的最高温度为400°C (750°F)。对于大多数无铅应用来说这已被视为足够高温。	主机的温度范围在90-450°C (190-840°F)。更改温度限制用于不常见的应用,如低/高熔点锡焊 (HMP) 或者塑料应用 (比如铆合)。	 在大多数情况下,工作温度超过 400°C (750°F) 会损坏电路板及其组件。甚至于焊嘴与焊点更短时间的接触,使助焊剂无法发挥正常功效,严重降低烙铁头寿命。如果焊点需要更大功率 (比如多层板或者高散热板), JBC强烈推荐配合使用其他辅助产品如预热台。
最低温度 设定进行工作的最低温度。 默认的最低温度为200°C (392°F)。对于有铅应用来说这被视为适当的起始温度。		
节奏提示 在每1-50秒重复的一种蜂鸣声。	可用来设定在重复作业时的工作速率。蜂鸣声提醒您必须开始焊接的时间段。	不适用
帮助文本 激活此参数可以从系统中获得的信息。	不适用	不适用
提示音 开启/禁用按键的提示音。	不适用	不适用
修改个人密码 修改默认的安全密码 (0105)。	每次更改参数必须输入个人密码。	不适用

工具设置

参数描述	建议	警告
<p>固定一个温度 固定一个温度值范围在 (90-450°C/190-840°F)。</p>	<p>非常适合需要在特定温度下焊接多个组件。主机将拒绝任何更改温度的意图。</p>	<p>不适用</p>
<p>温度等级设置 类似于“固定一个温度”的参数。在这种情况下, 用户可以根据不同的功率要求设置最多3个温度值。</p>	<p>这允许在3个不同温度之间快速切换。根据您的焊接应用允许的温度值来设置。</p>	<p>不适用</p>
<p>睡眠延时 设置工具在置放架上起并保持所选温度到进入睡眠模式的时间。焊嘴温度随即降到睡眠温度 (默认150°C/302°F 或者 260°C/500°F 只适用于拆焊)。</p>	<p>因为我们的工具可以仅在2秒内从默认睡眠模式升到工作温度, 此参数预设为0分钟。一旦工具被回放到置放架上, 温度将自动降到睡眠温度, 延长焊嘴寿命并防止氧化。工具在放置到置放架上之前做加锡保养可防止涂层的磨损。</p>	<p> 没必要将这些参数设置过高, 会导致焊嘴加速氧化并缩短焊嘴寿命, 特别是在450°C (840°F)的温度下作业。</p>
<p>睡眠温度 当工具在置放架时, 焊嘴将达到到的设定温度。</p>	<p>在防氧化和几秒内快捷升温到工作温度, 睡眠温度的设置实现了两者之间的一种折中方案。</p>	

焊嘴设置

参数描述

休眠延时
设置工具从睡眠温度进入休眠模式的时间。默认设置为10分钟。这段时间之后，电源被切断，焊嘴温度降至室温。

建议

此功能完全防止工具在置放架上长时间不使用而产生的氧化。
放置到置放架之前对工具做加锡保养也有助于保护涂层，防止焊嘴氧化，延长焊嘴寿命。

警告

 增大默认值将加速焊嘴的氧化和缩短其使用寿命。

温度修正

提供所选温度和实际温度之间的更精确的修正。

设置数值在 $\pm 50^{\circ}\text{C}$ ($\pm 90^{\circ}\text{F}$) 以实现零失误。JBC强烈推荐
使用TID-A或TIA-A测温仪以获得精确的读数。

 当用户更换烙铁头类型，此参数须重设至 $0^{\circ}\text{C}/\text{F}$ 或者适合该烙铁头的温度值。比如，为C245966 (粗类型) 设置的修正值为 $+20^{\circ}\text{C}$ ($+36^{\circ}\text{F}$)，之后用户更换到C245030 (较细类型) 而没有重设修正值，在C245030不需要调整温度的情况下，用户实际上在低 20°C ($+36^{\circ}\text{F}$) 的温度下作业。

维护

在维护或储存之前需确保设备已经冷却。

- 用玻璃清洁剂或抹布清洁主机屏幕。
使用抹布清洁外壳和工具。
酒精只可用来清洁金属部件。
- 定期检查工具金属件及支架, 确保清洁,
确保主机可以保持探测到工具状态。
- 储存前, 保持烙铁头清洁并加锡保养以防
氧化。
生锈或肮脏的表面会减少传递到焊点的热
量。
- 定期检查电线和管子。
- 按如下图示更换熔断保险丝:

1. 推动黑色盖子取下保险丝。如有必要可使
用工具。

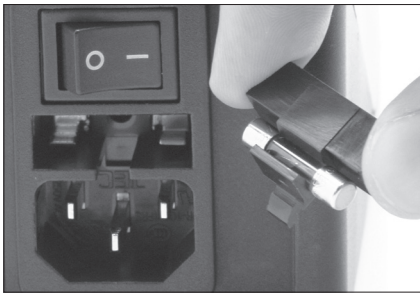

2. 将新的保险丝放入保险丝盒, 并将其放入
工作台。

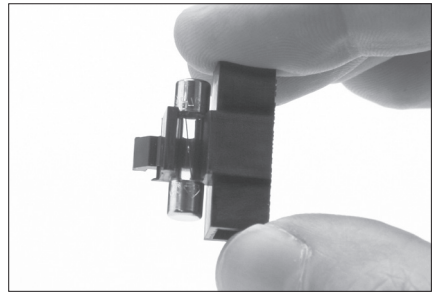

- 更换任何受损的元件。仅使用JBC原装配件。
- 修理必须由JBC专业技术服务人员进行。

安全



必须遵守安全准则，以防止电击，人身伤害，火灾或爆炸。

- 不要使用本产品用于焊接或返修以外的任何目的。不正确使用可能造成火灾。
- 电源线必须插入核准的电源。确保使用前妥善接地。拔掉电源时握住插头，而不是电线。
- 请勿在带电部件上操作。
- 该工具在不使用时应放置在支架上，以激活休眠模式。
烙铁头，金属部分和支架即使在焊台被切断电源时仍旧是热的。
小心轻放，包括调整支架位置时。
- 设备开着时，切勿无人看管。
- 请勿覆盖通风口。热量可引起易燃物品引燃。
- 使用“无残渣”类锡丝，避免与皮肤或眼睛接触，以防刺激。
- 小心焊接时产生的烟雾。
- 保持工作场所干净整洁。操作时，为避免造成人身伤害，请穿戴适当的防护眼镜和手套。
- 残锡液易引起灼伤，请小心处理。
- 本产品允许八岁以上儿童，肢体，感官或心智有残缺的人士，以及缺乏经验的人士使用，但必须提供必要的监护及指导，并且了解本产品可能涉及的危险。切勿让儿童把玩。
- 没有监管，儿童不得对本产品进行维护。

技术规格

CD-2SHE 230V 50/60Hz. 输入保险丝: 1A. 输出: 23,5V. 主机款式: CD-2HE

- 重量: 2.7 Kg (5.9 lb)
- 尺寸: 150 x 175 x 145 mm
- 最高输出功率 CD-SHE: 40W
- 温度范围: 90-450°C (190°-840°F) (±5%)
- 空置温度稳定性 (静止空气): ±1.5 °C / ±3 °F
- 焊接接地电阻: <2 ohms
- 焊接接地电压: <2mV RMS
- 工作室温: 10-40 °C / 50-104 °F
- USB 连接焊台-PC

符合CE标准
防静电“趋肤效应”保护外壳

分解圖

CD-2SHE 230V

精密焊接台

来自186802系列

备件	
CD-2HE	0018963
-电路盒	0016248
-主机台	0012994
-防溅罩	0017576
-防溅层	0017574

CD-2SHE 230V 保险丝 T-1A

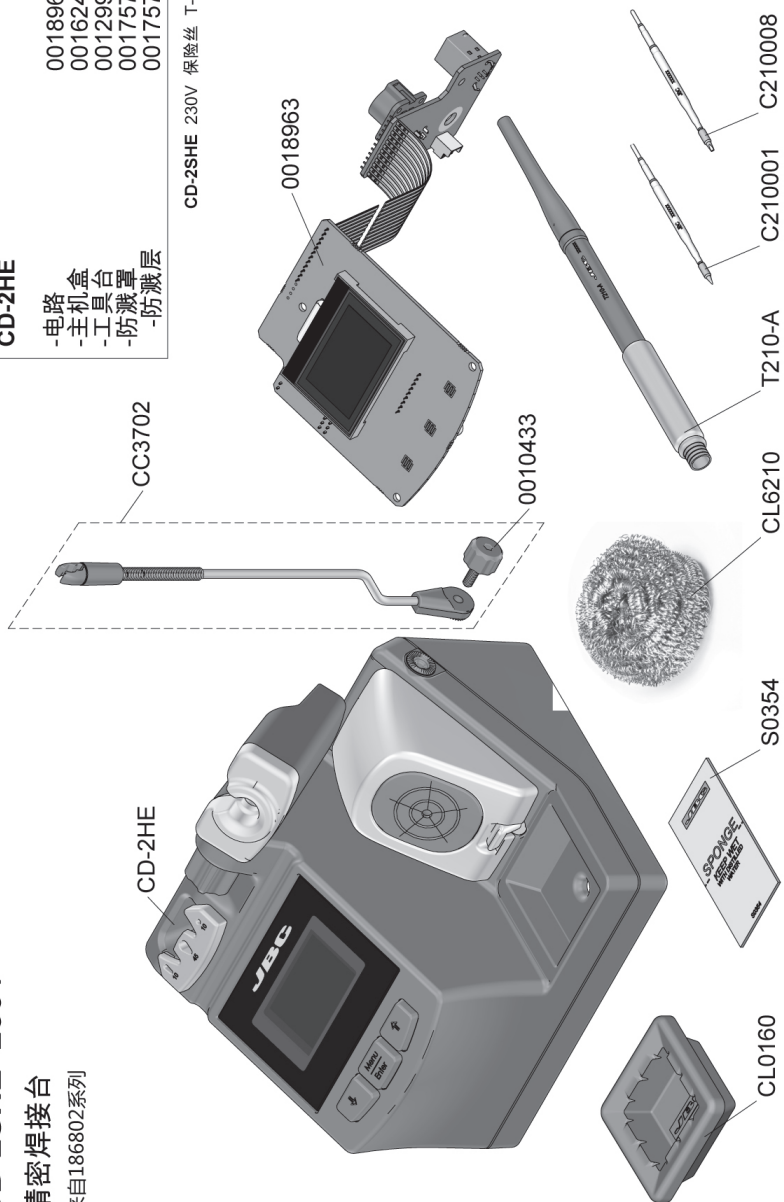

Precision Soldering Station

Ref. CD-2SHE

Packing List

The following items should be included:

CD Control Unit 1 unit
Ref. CD-2HE (230V)



Precision Purpose Handle 1 unit
Ref. T210-A



Power Cord 1 unit
Ref. 0009401 (230V)



Cartridges 2 units
Ref. C210001 (x1)
C210008 (x1)



Brass Wool 1 unit
Ref. CL6210

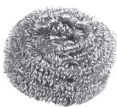

Sponge 1 unit
Ref. S0354



Manual 1 unit
Ref. 0017070



Features

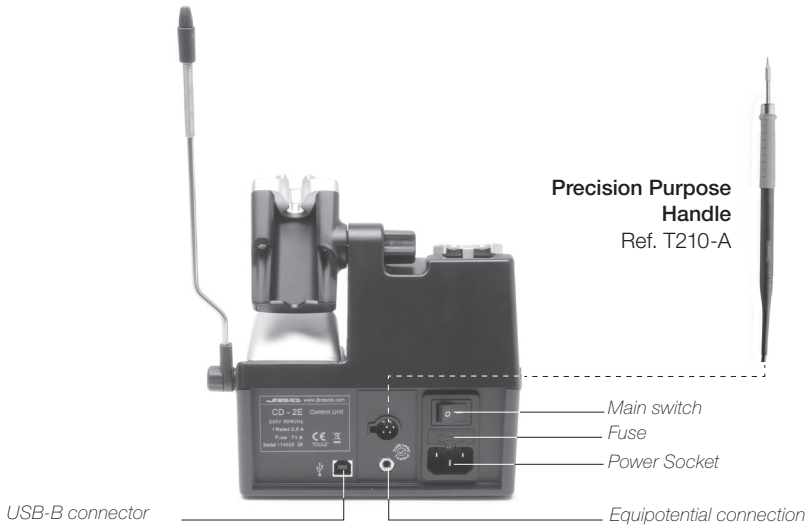

Adjustable stand

Adjust the tool stand to suit your work position.

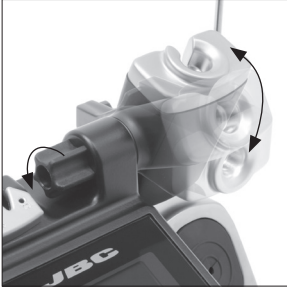

Cable collector (Ref. CC3702)

Place the cable on the collector so that the working area is free of cable.

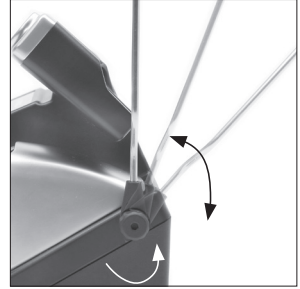
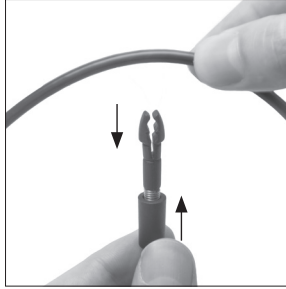

Tip Cleaner

Select the option to suit your needs and improve the thermal transfer of the tip.

Splashguard

Ref. 0017576

It prevents splashing of solder particles when using the brass wool.

Antisplash Membrane

Ref. 0017574

Prevents splashing to maintain the work area clean.

Brass Wool

Ref. CL6210

Very effective cleaning method. Leaves a small layer of solder on the tip preventing oxidation between cleaning and rewetting.

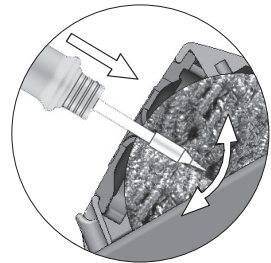

If the tip is very dirty, JBC recommends first cleaning it with the wiper to remove excess solder.

Wiper Ref. CL0160

A temperature resistant tray for removing excess solder by gently tapping or wiping.

Removing the Splashguard

1. Unlock the splashguard.



2. Remove it.

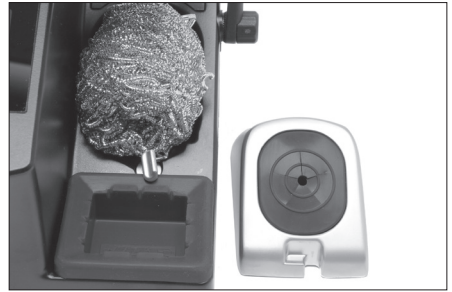

Alternative cleaning options (not supplied):

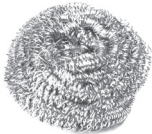

Inox Wool
Ref. CL6205
Provides a superior cleaning of the tip.



Metal Brush
Ref. CL6220
When used carefully, it cleans more thoroughly.

Wiper

Ref. CL0160

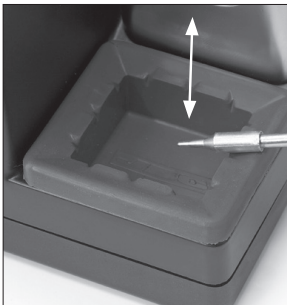

Tapping:

Tap gently to remove excess solder.

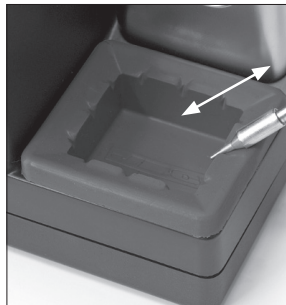

Wiping:

Use the slots to remove remaining particles.

Sponge

Ref. S0354

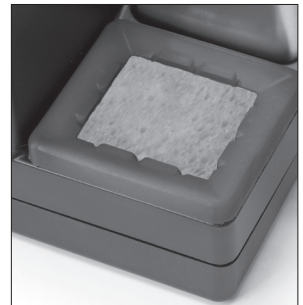

The least harmful cleaning method. Keep the sponge damp with distilled water when working to avoid tip wear.

Compatible Handles

For general use

Works with C245 Cartridge range

General Purpose Handle

Ref. T245-A

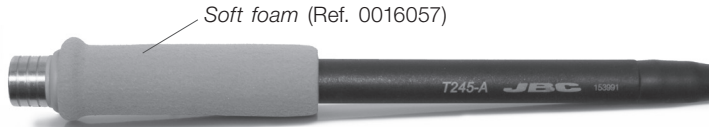

Blue Handle

Ref. T245-PA



Non-slip Handle

Ref. T245-B



Easily replace the **Grips for T245-A** using the slip-on tabs (Ref. 0016057 Supplied with 4 grips).

1. Inserting tabs

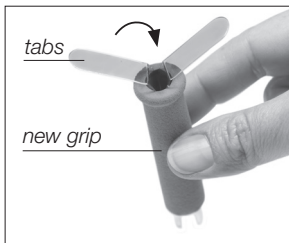

Insert the slide-on tabs into the new grip.

2. Inserting handle

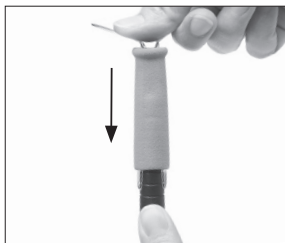

Push the grip with the tabs onto the handle.

3. Removing tabs

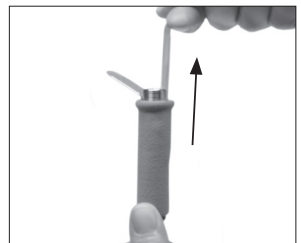

To remove the tabs, hold the grip and pull them out. Use a pliers if necessary.

Note: All models are supplied with a 1.5 m cable.

For precision use

Works with C210 Cartridge range

Precision Purpose Handle

Ref. T210-A



Blue Precision Handle

Ref. T210-PA



Blue grip to quickly distinguish from other handles

For greater demands

Important: Only work with C245 cartridges when used with a CD station.

For intensive soldering jobs requiring continued high thermal power. They feature good thermal insulation and a screw which fixes the cartridge and prevents its rotation.

HD Purpose Handle

Ref. T470-A



HD Purpose Handle + 3 m cable

Ref. T470-SA

Tri-lobed Handle

Ref. T470-ZA

For better handling of the tool.



Thermal Insulator HD Handle

Ref. T470-FA



Thermal Insulator HD Handle + 3 m cable

Ref. T470-MA

Foam

Note: All models are supplied with a 1.5 m cable except those specified with 3 m.

Quick Tip Changer

Save time and change cartridges safely without switching the station off.

1. Removing



Place the handpiece in the extractor and pull to remove the cartridge.

2. Inserting

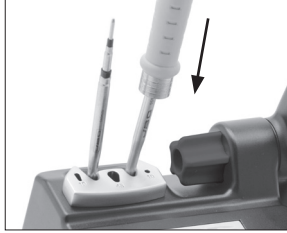

Place the handpiece on top of the new cartridge and press down slightly.

3. Fixing

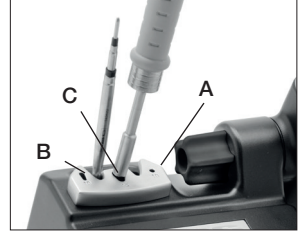

Use the holes for fixing the cartridge* as follows:
A. For straight C210.
B. For curved C210.
C. For C245.

*Important

It is essential to insert the cartridges as far as the mark for a proper connection.

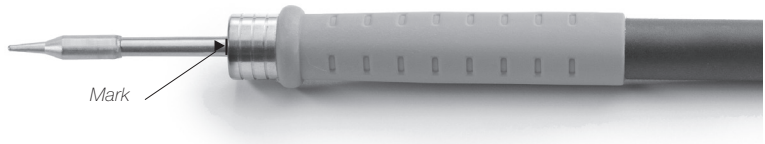

Compatible cartridges

The CD stations work with C245 cartridges and T245/T470 handpieces or C210 cartridges with T210 handpieces. Find the model that best suits your soldering needs in www.jbctools.com

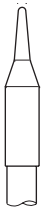

Round



Chisel



Round bent



Bevel

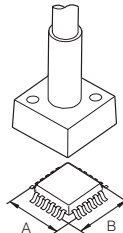

Special models

USB Connector

Download the latest software from our website to improve your soldering station.

JBC Updater

www.jbctools.com/software.html

Update the station software via USB connection:



JBC Manager

www.jbctools.com/manager.html

Manage and monitor as many stations as your PC can handle by using the JBC Manager. You can export data to another PC.

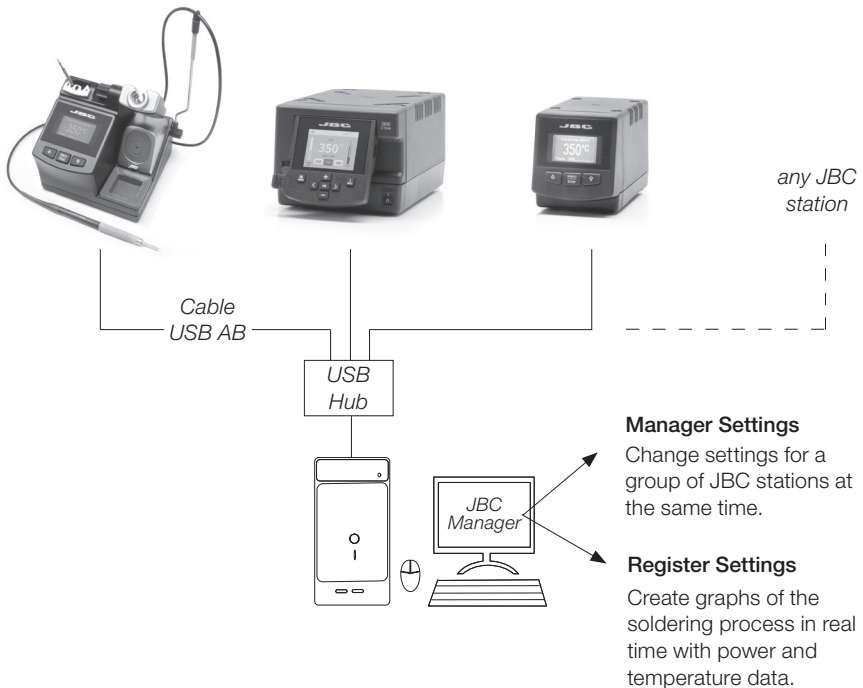

Operation

The JBC Exclusive Heating System

This revolutionary technology is able to recover tip temperature extremely quickly.

This allows the user to work at a lower temperature.

As a result, tip life increases up to 5.

1. Work



When the tool is lifted from the stand the tip will heat up to the selected temperature.

2. Sleep



When the tool is in the stand, the temperature falls to the preset sleep temperature.

3. Hibernation

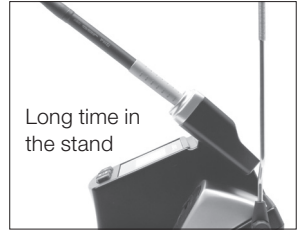

Long time in the stand

After longer periods of inactivity, the power is cut off and the tool cools down to room temperature.

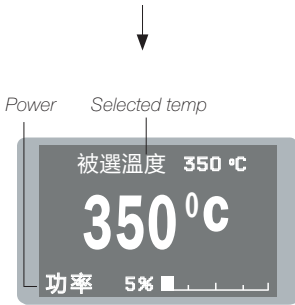

- Change temperature (from 90 to 450°C)
- Select temperature levels
- Fix one temperature



- Change Sleep temperature
- Set Sleep delay (from 0 to 9 min or no Sleep)

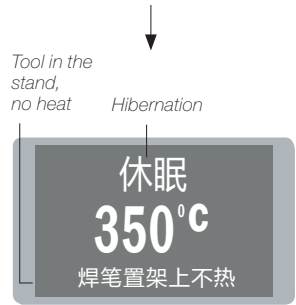

- Change Hibernation delay (from 0 to 35 min)

Control Process

Work Screen

The diagram illustrates the Work Screen interface with three main sections:

- Fixed temp:** A top bar showing '鎖定溫度 350 °C'. A callout indicates it 'Displays a specific fixed temp.'
- Temp levels:** A middle bar showing '等級 °C 270 350 400'. A callout notes it is 'Shown when you have selected temp. levels. The values must be adjusted according to the work needs.'
- Main display:** A large central area showing '被選溫度 350 °C', a large '350 °C' reading, and '功率 5%' with a progress bar. A callout for the '-10' value states: '"Temp. Adjust" parameter. It provides a more precise adjustment between the selected temp and the actual one.'

Navigation buttons at the bottom include a down arrow, a 'Menu / Enter' button, and an up arrow.

Menu Screen

Original PIN: 0105

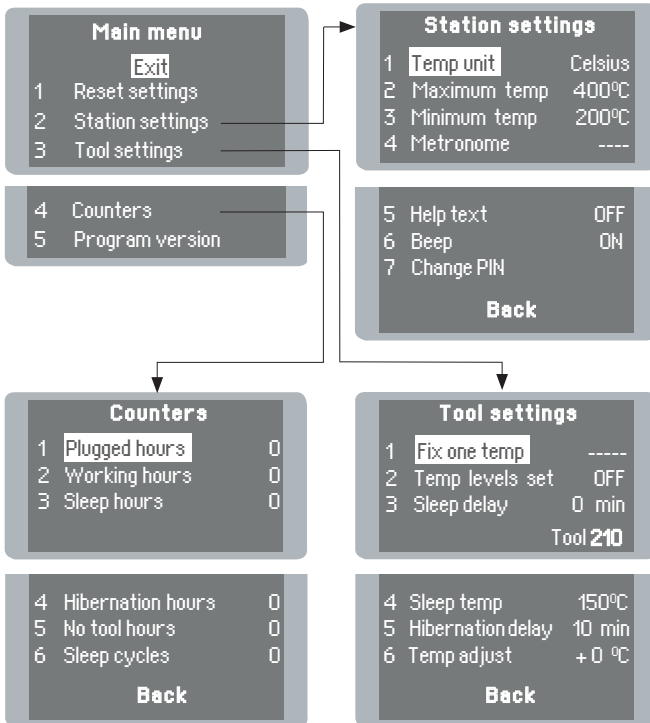

Parameters

Be careful when using these parameters as they may reduce the tip life if not used properly. Please follow the recommended guidelines:



Station Settings

Parameter description	Recommendations	Warnings
<p>Temperature unit Celsius (°C) or Fahrenheit (°F)</p>	N/a	
<p>Maximum temperature Set the maximum temperature to work with. Max. temp by default is 400°C (750°F). This is considered high enough to work with most lead-free applications.</p> <hr/> <p>Minimum temperature Set the minimum temperature to work with. Min. temp. by default is 200°C (392°F). This is considered to be a proper starting point for leaded applications.</p>	<p>The station temperature range is 90-450°C (190-840°F). Change the temperature limits when working with less common applications such as low / high melting point soldering (HMP) or plastics (e. g. riveting).</p>	<p> In most cases, working with temperatures over 400°C (750°F) can damage the PCB and its components. Even in short time periods of tip contact with the soldering joint, the flux may not work properly and could seriously reduce tip life.</p> <p>If the solder joint requires more power (e.g. multilayered or high dissipation boards), JBC strongly recommends using other aids like preheaters.</p>
<p>Metronome This activates a beep sound. Frequencies vary from 1 to 50 seconds.</p>	Useful for setting a work rate in repetitive jobs. The beep lets you know the length of time the tip must be in contact with the soldering joint.	N/a
<p>Help text Activate this parameter to receive info from the system.</p>	N/a	N/a
<p>Beep Enable/disable the beep sound of the keypad.</p>	N/a	N/a
<p>Change pin Change the default security PIN number (0105).</p>	The PIN must be entered every time a parameter is changed.	N/a

Tool Settings

Parameter description	Recommendations	Warnings
<p>Fix one temperature Fix a value within the temperature range of the station (90 - 450°C / 190 - 840°F).</p>	<p>Ideal for soldering more than one component at a specific temperature. The station will reject any attempt to change the temperature.</p>	<p>N/a</p>
<p>Temperature levels set Similar to “Fix one temp” parameter. In this case, the user can set up to 3 values for different power requirements.</p>	<p>This allows a quick change between 3 different temperatures. Set them according to the allowed values for your soldering applications.</p>	<p>N/a</p>
<p>Sleep delay Set the time that the tool will remain at the selected temperature when in the stand before entering sleep mode. The tip temperature will then drop to the Sleep temperature.</p>	<p>Because our tools reach the working temperature from the default Sleep mode in only a few seconds, this parameter is preset to 0 min. Once the tool is returned to the stand the temperature will automatically drop to the sleep temperature, extending tip life and avoiding oxidation. Retinning the tip before placing the tool in the stand will protect the tip and extend its life.</p>	<div style="background-color: #e0e0e0; padding: 10px;"> <p> Setting these parameters to higher values will unnecessarily accelerate oxidation and shorten tip life especially when working with temperatures up to 450°C (840°F).</p> </div>
<p>Sleep temperature This is the set temperature the tip reaches when returned to the stand.</p>	<p>The sleep temperatures are set to achieve a balance between preventing oxidation and reaching the working temperature in a few seconds.</p>	

Tool Settings

Parameter description	Recommendations	Warnings
Hibernation Delay Set the time the tool will remain at Sleep temperature before entering the Hibernation mode. At this time, the power supply is cut off and the tip remains at room temperature.	This function completely protects the tip from oxidation during long periods of inactivity while the tool is in the stand. Retinning the tip before placing the tool in the stand also helps prevent oxidation and extends the life of the tip.	 Increasing the default value will accelerate oxidation and shorten the tip life.
Temp Adjustment It provides a more precise adjustment between the selected temperature and the actual one.	Set values within $\pm 50^{\circ}\text{C}$ ($\pm 90^{\circ}\text{F}$) to achieve zero error. JBC strongly recommends the use of TID-A or TIA-A Thermometers to obtain precise readings.	 When the user changes the cartridge type, the parameter should be reset to $0^{\circ}\text{C}/\text{F}$ or to the value needed for this cartridge. E.g. If a correction of $+20^{\circ}\text{C}$ ($+36^{\circ}\text{F}$) is set for the C245966 (thick type) and then the user changes the cartridge for a C245030 (which is thinner) without resetting, they would be working at a temperature of $+20^{\circ}\text{C}$ ($+36^{\circ}\text{F}$) lower for the C245030 which does not need any temperature adjustment.

Maintenance

Before carrying out maintenance, always allow the equipment to cool.

- Clean the station screen with a glass cleaner or a damp cloth.
- Use a damp cloth to clean the casing and the tool. Alcohol can only be used to clean the metal parts.
- Periodically check that the metal parts of the tool and stand are clean so that the station can detect the tool status.
- Maintain tip surface clean and tinned prior to storage in order to avoid tip oxidation. Rusty and dirty surfaces reduce heat transfer to the solder joint.
- Periodically check all cables and tubes.

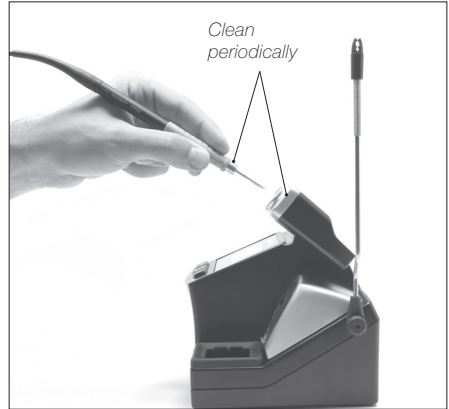

- Replace a blown fuse as follows:

1. Pull off the fuse holder and remove the fuse. If necessary use a tool to lever it off.

2. Press the new fuse into the fuse holder and replace it in the station.

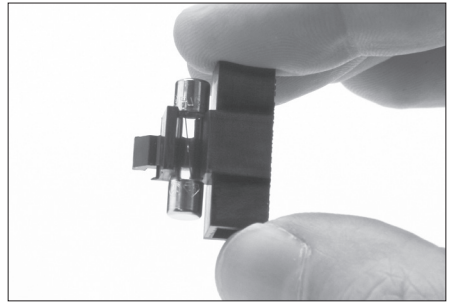
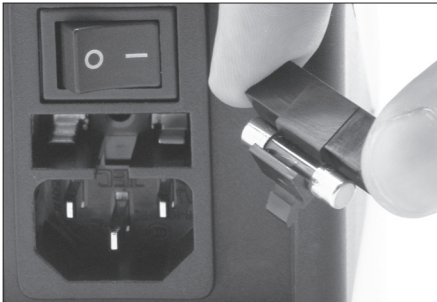

- Replace any defective or damaged pieces. Use original JBC spare parts only.
- Repairs should only be performed by a JBC authorized technical service.

Safety



It is imperative to follow safety guidelines to prevent electric shock, injury, fire or explosion.

- Do not use the units for any purpose other than soldering or rework. Incorrect use may cause fire.
- The power cable must be plugged into approved bases. Make sure that it is properly grounded before use. When unplugging it, hold the plug, not the wire.
- Do not work on electrically live parts.
- The tool should be placed in the stand when not in use in order to activate the sleep mode. The soldering tip, the metal part of the tool and the stand may still be hot after the station is turned off. Handle with care, including when adjusting the stand position.
- Do not leave the appliance unattended when it is on.
- Do not cover the ventilation grills. Heat can cause inflammable products to ignite.
- Avoid flux coming into contact with skin or eyes to prevent irritation
- Be careful with the fumes produced when soldering.
- Keep your workplace clean and tidy. Wear appropriate protection glasses and gloves when working to avoid personal harm.
- Utmost care must be taken with liquid tin waste which can cause burns.
- This appliance can be used by children over the age of eight as well as persons with reduced physical, sensory or mental capabilities or lacking experience provided that they have been given adequate supervision or instruction concerning use of the appliance and understand the hazards involved. Children must not play with the appliance.
- Maintenance must not be carried out by children unless supervised.

Specifications

CD-2SHE 230V 50/60Hz. Input fuse: 1A. Output: 23,5V. Control Unit model: **CD-2HE**

- Weight: 2.6 Kg (5.7 lb)
- Dimensions: 150 x 175 x 145 mm
- Output Peak Power: 40W
- Temperature Range: 90-450°C (190°-840°F) (±5%)
- Idle Temp. Stability (still air): ±1.5 °C / ±3 °F
- Tip to ground resistance: <2 ohms
- Tip to ground voltage: <2mV RMS
- Ambient operating temp: 10-40 °C / 50-104 °F
- USB connector station-PC

Complies with CE standards
ESD protected housing "skin effect"

Exploded

SPARE PARTS	
CD-2HE	
-CIRCUIT	0018963
-ENCLOSURE	0016248
-TOOL STAND	0012994
-SPLASHGUARD	0017576
-ANTISPLASH RUBBER	0017574

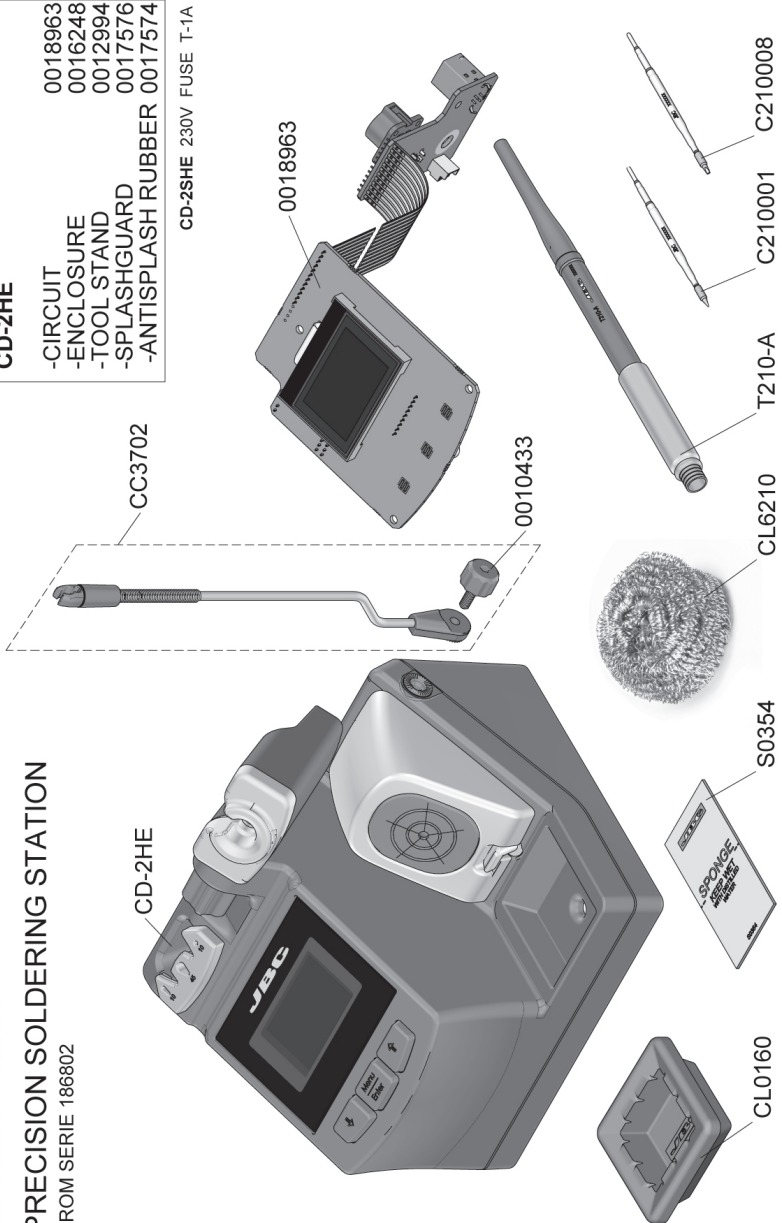

CD-2SHE 230V
PRECISION SOLDERING STATION
 FROM SERIE 186802

保修

JBC的2年保修涵盖了该设备所有的制造缺陷,包括更换有缺陷的零件和人工耗时。

保修不包括因过度使用或误用而产生的产品损坏。

为了使保修有效,设备须返还至购买时的经销商处返修, 邮资自理。

Warranty

JBC's 2 year warranty covers this equipment against all manufacturing defects, including the replacement of defective parts and labour.

Warranty does not cover product wear or misuse.

In order for the warranty to be valid, equipment must be returned, postage paid, to the dealer where it was purchased.



本产品不应被扔在垃圾筒内。

根据欧盟条款2012/19/EU, 电子设备在其寿命结束后必须被回收并转运至授权回收工厂。

This product should not be thrown in the garbage.

In accordance with the European directive 2012/19/EU, electronic equipment at the end of their life must be collected and returned to an authorized recycling facility.