

# JBC

[www.jbctools.com](http://www.jbctools.com)

## INSTRUCTION MANUAL



### Stands for Desoldering Iron

Ref. DS-SE / DR-SE

# Packing List

**Stand** ..... 1unit  
Ref. DS-SE

**Stand** ..... 1 unit  
Ref. DR-SE

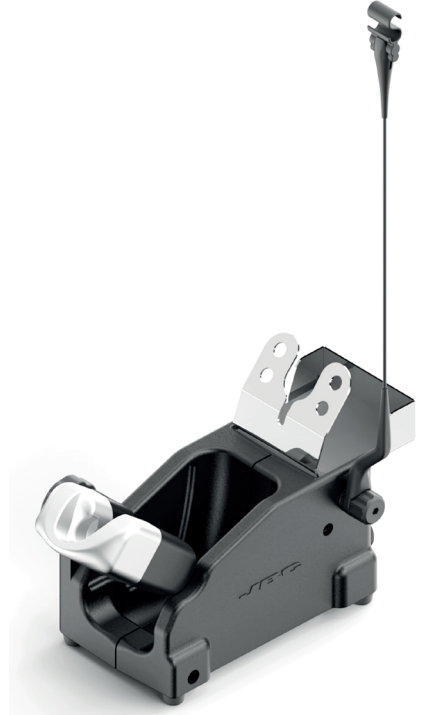

The following items are included in each stand:

**Stand Cable 1m**..... 1 unit  
Ref. 0011283

**Cable Holder**..... 1 unit  
Ref. 0010154

**Manual** ..... 1 unit  
Ref. 0021652

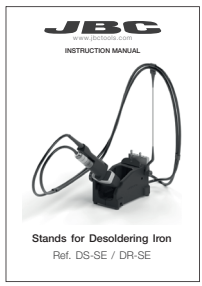

## Features

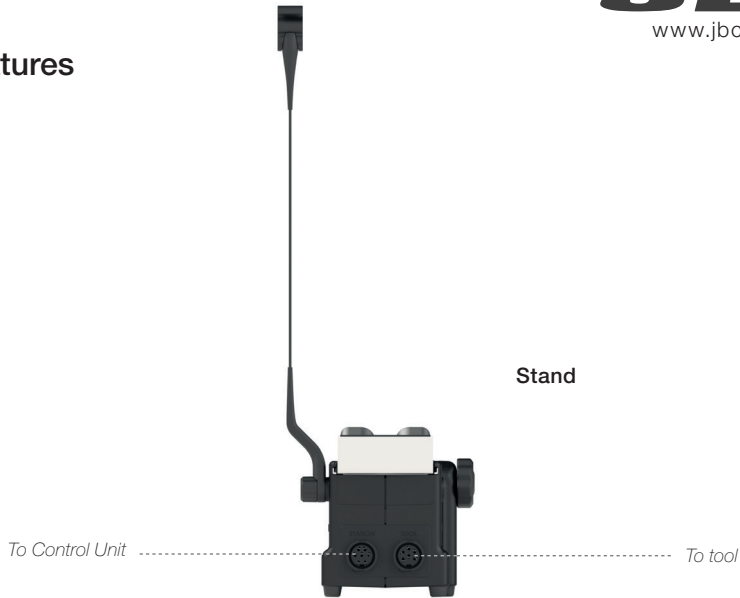

## Extractors

Ref. DS-SE

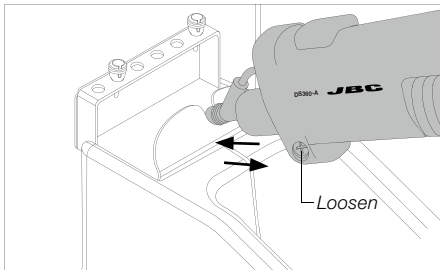

Place the Soldering Iron in the extractor and remove the tip.

Insert the new tip and press slightly.

Use the holes to place the different tips.

## Tips holder

Ref. DR-SE

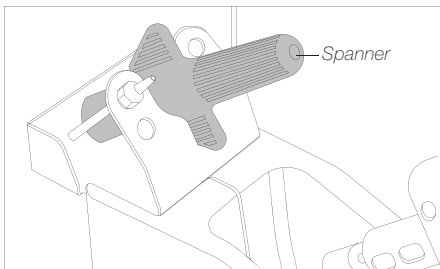

Use the spanner to remove and replace the tips.

Use the holes to place the different tips, and place the spanner in the middle of the storage rack.

# Assembly: Collector and Adjustable Tool Holder

Assembly for DR and DS stands.

**Cable holder**  
Ref. 0010154

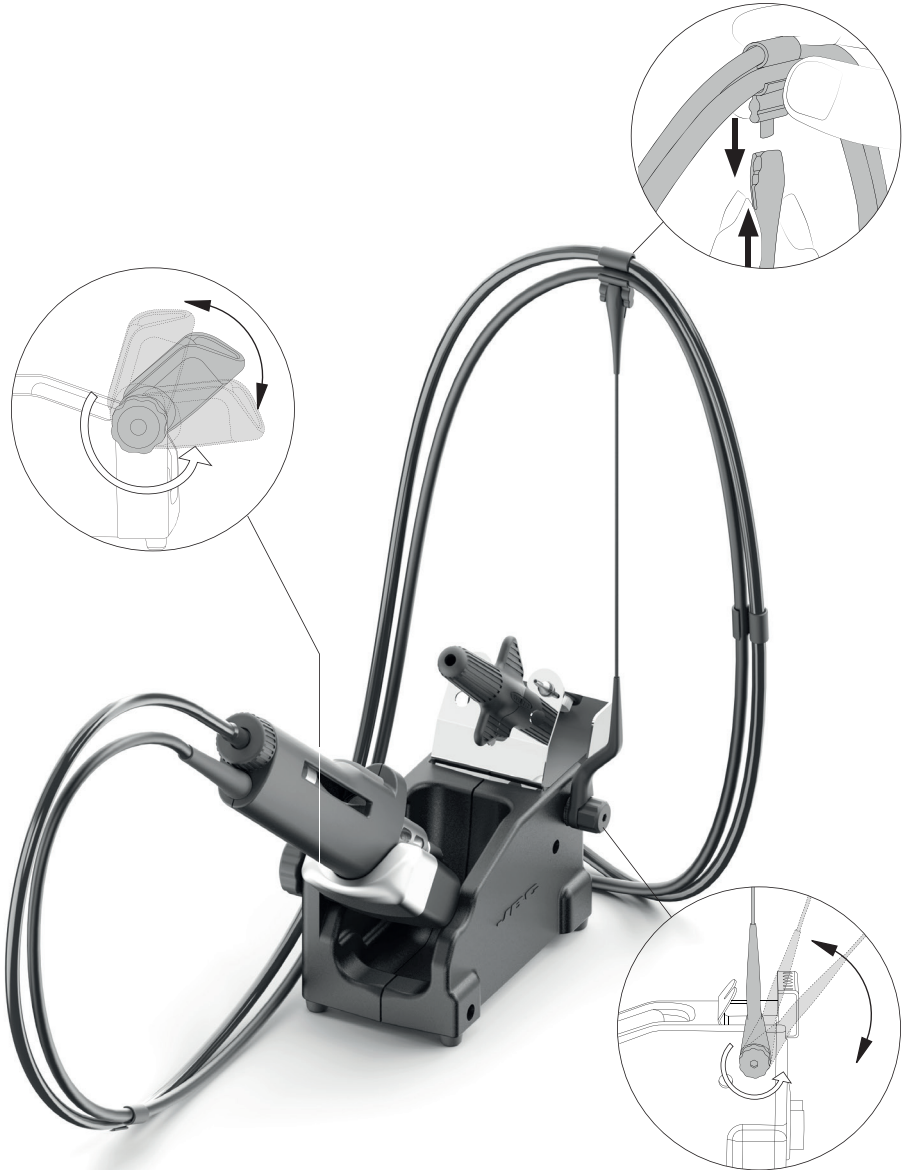

## Accessories

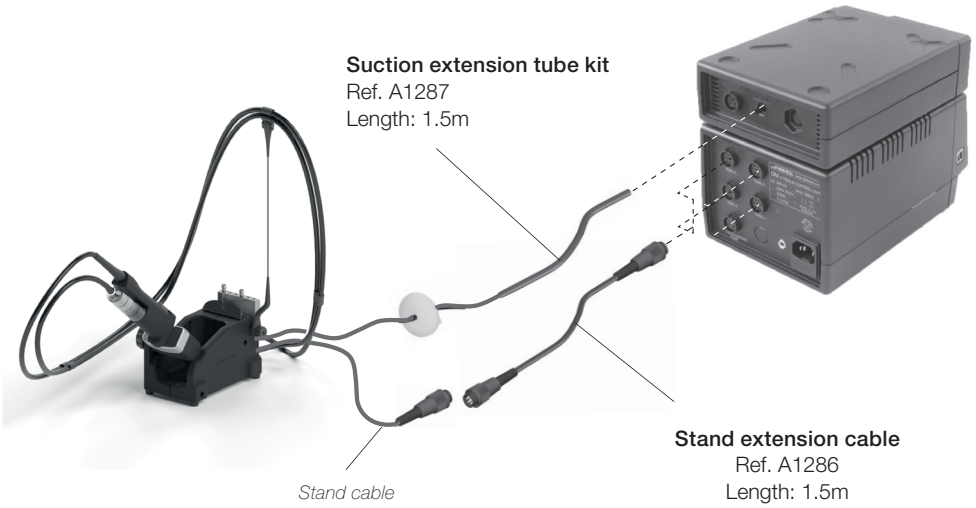

## Maintenance

Before carrying out maintenance or storage, always unplug the stand from the station and the tool.

- Use a damp cloth to clean the stand. Alcohol can be used only when cleaning the metal parts.
- Check periodically that the metal parts of the tool/stand are clean so that the station can check the tool's status.
- Periodically check all cables and tube connections.
- Replace any defective or damaged parts. Use original JBC spare parts only.
- Repairs should only be performed by a JBC authorized technical service.

*Clean periodically*



## Safety



**It is imperative to follow safety guidelines to prevent electric shock, injury, fire or explosion.**

- Do not use the stand for any other purpose than soldering or rework.
- The power cord must be plugged into approved bases. Be sure that it is properly grounded before use. When unplugging it, hold the plug, not the wire.
- The tool should be placed in the stand when not in use in order to activate the sleep mode. The soldering tip, the metal part of the tool and the stand may still be hot even when the station is turned off. Handle with care, including when adjusting the stand position.
- Avoid the contact of flux with skin or eyes to prevent irritation.
- Be careful with the fumes produced when soldering.
- Keep your workplace clean and tidy. Wear appropriate protection glasses and gloves when working to avoid personal harm.
- Utmost care must be taken with liquid tin waste which can cause burns.
- This appliance can be used by children over the age of eight and also persons with reduced physical, sensory or mental capabilities or lack of experience provided that they have been given adequate supervision or instruction concerning use of the appliance and understand the hazards involved. Children must not play with the appliance.
- Maintenance must not be carried out by children unless supervised.

# Specifications

## DS-SE

- Includes Sleep Mode
- Net Weight 1.260 kg (2.78 lb)
- Package Weight 1.553 kg (3.42 lb)
- Package Dimensions 342 x 155 x 120 mm (13.46 x 6.10 x 4.72 in)

## DR-SE

- Includes Sleep Mode
- Net Weight 1.411 kg (3.11 lb)
- Package Weight 1.687 kg (3.72 lb)
- Package Dimensions 342 x 155 x 120 mm (13.46 x 6.10 x 4.72 in)

Complies with CE standards  
ESD protected



### Warranty

JBC's 2 year warranty covers this equipment against all manufacturing defects, including the replacement of defective parts and labour.

Warranty does not cover product wear or misuse.

In order for the warranty to be valid, equipment must be returned, postage paid, to the dealer where it was purchased.

**Get 1 extra year JBC warranty by registering here:**  
<https://www.jbctools.com/productregistration/>  
**within 30 days of purchase.**



This product should not be thrown in the garbage.

In accordance with the European directive 2012/19/EU, electronic equipment at the end of its life must be collected and returned to an authorized recycling facility.

