

JBC

www.jbctools.com

INSTRUCTION MANUAL



WSBT

Stand for WS140 and WS440

Index

	Page
Packing List	3
Features and Connections	4-5
Changing W140 Cartridges	6
Changing W440 Cartridges	7
Cartridge Range W140	8-9
Cartridge Range W440	10
Accessories	11
Maintenance	12
Safety	13
Specifications	16

This manual corresponds to the following reference:

WSBT-A

Packing List

The following items are included:



Stand for WS140 and WS440 1 unit



Stand Cable (length 1m)1 unit
Ref. 0024227

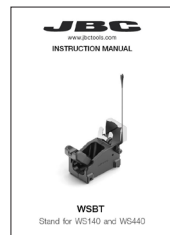

Manual 1 unit
Ref. 0027212

Features and Connections

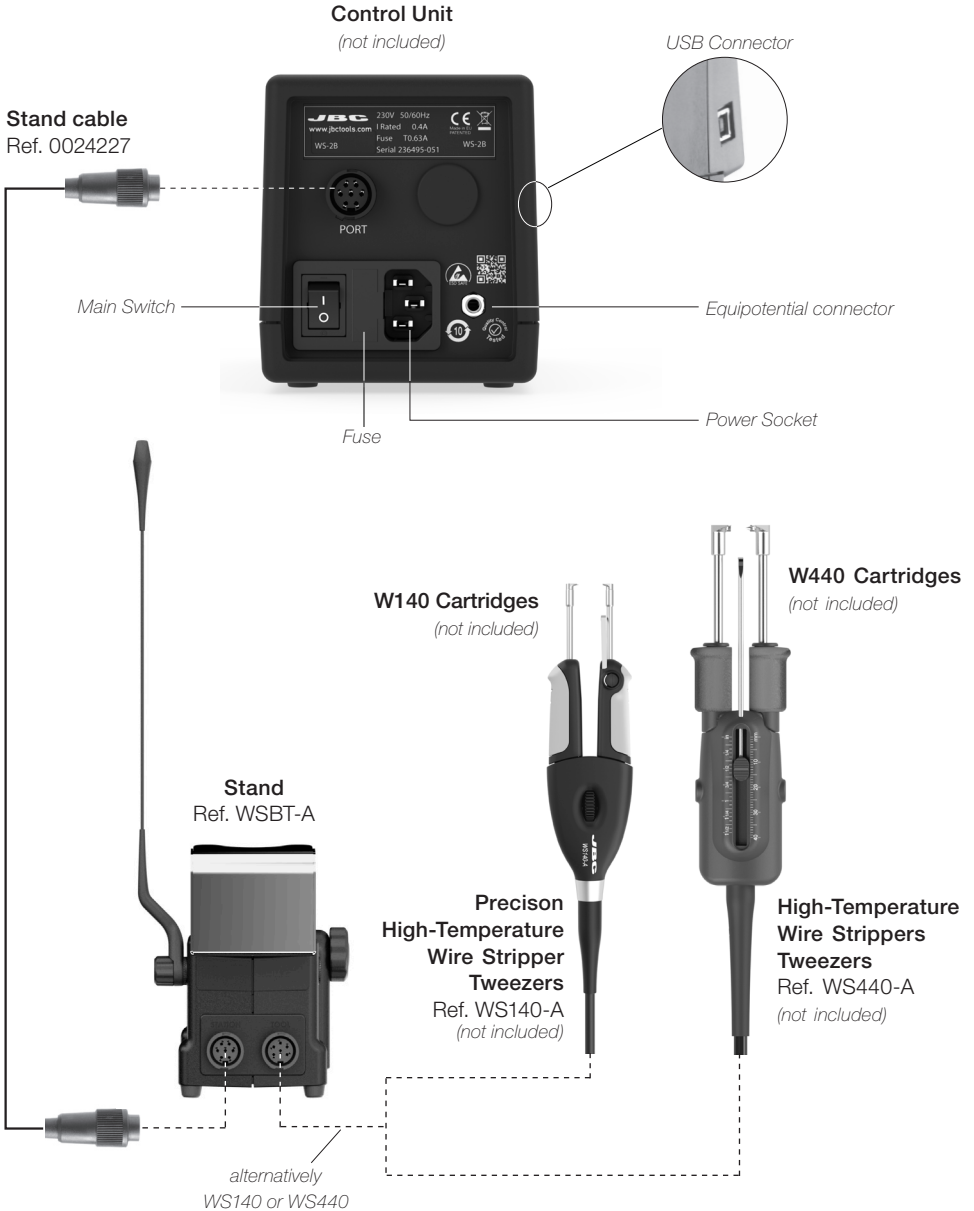

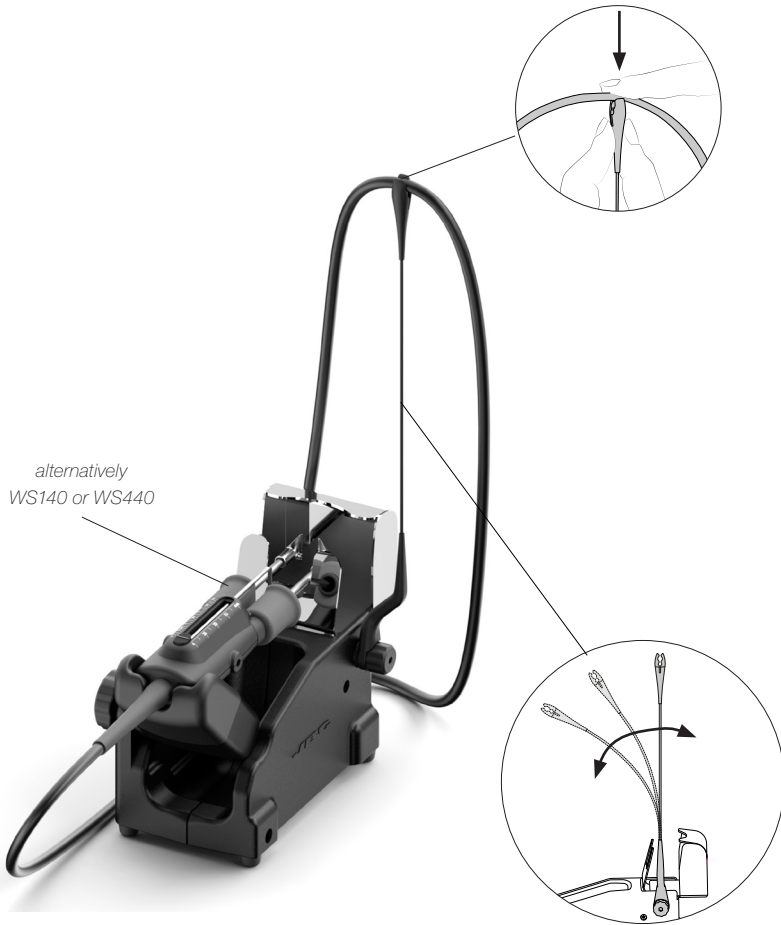

Changing W140 Cartridges

1. Removing

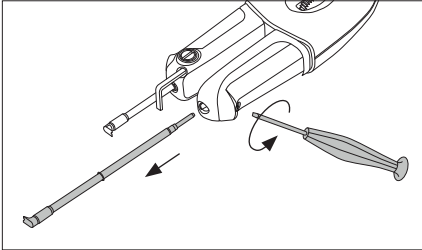

Loosen the screws and remove the cartridges.

2. Inserting

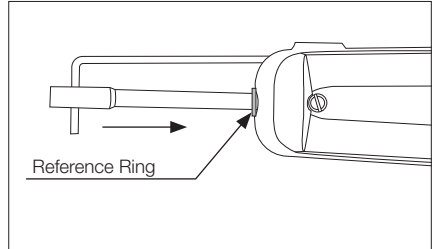

Insert the cartridge until the reference ring touch against the wire stripper. Take the ring as reference and check that both tips match.

Important: It is essential to insert the cartridge till the end for a good connection.

3. Positioning

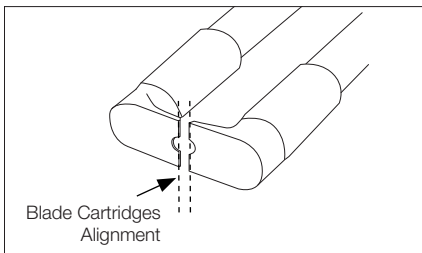

Align the tip edges and fix the cartridges in its working position.

3. Fixing

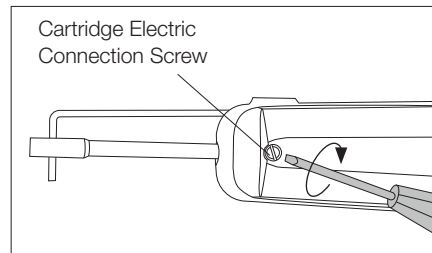

Tightening the screw.

Important: It is essential to tighten the screws for the tool to function.

Changing W440 Cartridges

1. Removing

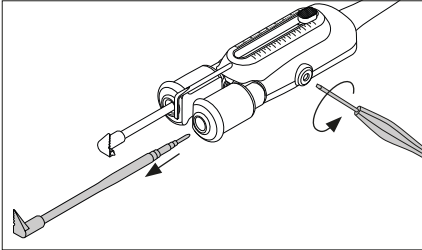

Loosen the screws and remove the cartridges.

2. Inserting

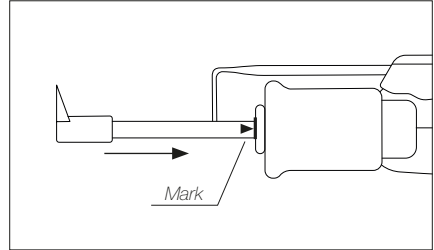

Insert the cartridge until the reference mark. Take the mark as reference and check that both tips match.

Important: It is essential to insert the cartridge till the mark for a good connection.

3. Positioning

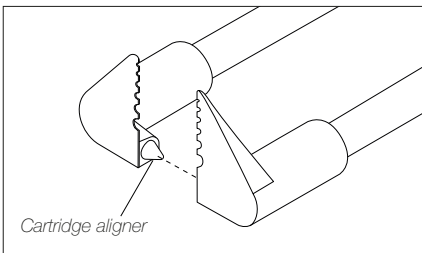

Align the cartridges in working position using a flat pliers (JBC Ref. PLR-195). The conical cartridge aligner helps centering both cartridges and ensure a good functionality.

4. Fixing

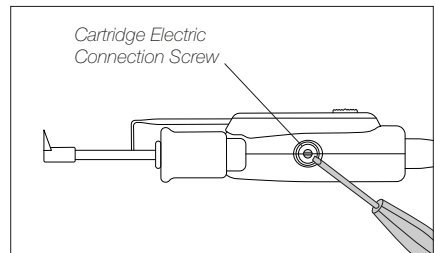

Fix the cartridges in its working position, by tightening the screw.

Important: It is essential to tighten the screws for the tool to function.

Cartridge Range W140

WS140-A is compatible with **W140** Blade Cartridge Range. Find the model that best suits your soldering needs on www.jbctools.com.

Cartridge Ref.	Tip Hole \varnothing mm / in	AWG Solid	AWG Stranded
W14040G	0,08 / 0,0031	40	x
W14038G	0,10 / 0,0039	38	x
W14037G	0,11 / 0,0043	37	x
W14036G	0,13 / 0,0051	36	x
W14034G	0,16 / 0,0063	34	36 (7x44)
W14032G	0,20 / 0,0079	32	34 (7x42)
W14030G	0,25 / 0,0098	30	32 (19x44)
W14028G	0,32 / 0,0126	28	30 (7x38)
			30 (19x42)
W14026G	0,40 / 0,0157	26	28 (19x40)
			27 (7x35)
W14024G	0,51 / 0,0201	24	26 (19x38)
			26 (10x36)

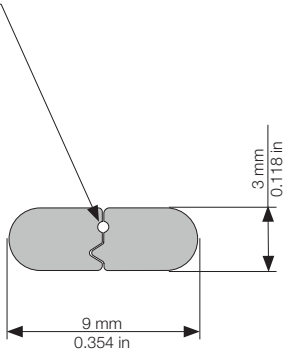

Cartridge Ref.	Tip Hole \varnothing mm / in	AWG Solid	AWG Stranded
W14022G	0,64 / 0,0252	22	24 (19x36)
			24 (7x32)
W14020G	0,81 / 0,0319	20	22 (19x34)
W14018G	1,02 / 0,0402	18	20 (42x36)
			20 (19x32)
			20 (7x28)

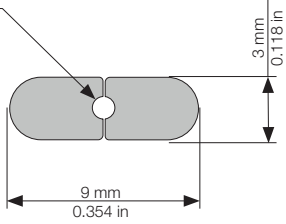

Cartridge Ref.	Tip mm / in
W14003F	Flat Tip 3 / 0.118

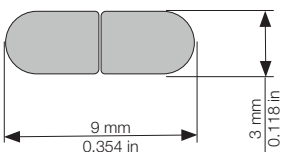

Cartridge Ref.	Tip Hole ø mm / in	AWG Solid	AWG Stranded	
W14016G	1,29 / 0,0508	16	18 (19x30)	
W14014G	1,63 / 0,0642	14	16 (7x24)	

Cartridge Ref.	Tip mm / in	
W14005F	Flat Tip 5 / 0.197	

If an application requires a special tip design, contact JBC by mail customtips@jbctools.com for special blade cartridges.

Cartridge Range W440

WS440-A is compatible with **W440** Blade Cartridge Range. Find the model that best suits your soldering needs on www.jbctools.com.

If an application requires a special tip design, contact JBC by mail customtips@jbctools.com.

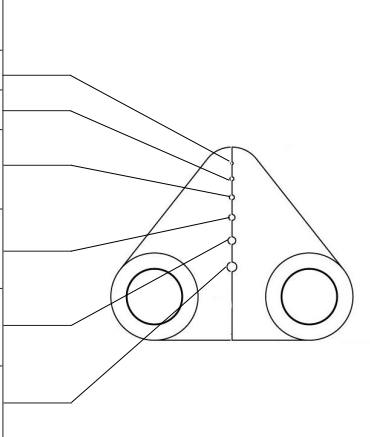
Cartridge Ref.	Tip Hole ø mm / in	AWG Stranded	AWG Solid	
W440021	0,16 / 0,0063	36 (7x44)	34	
	0,25 / 0,0098	32 (19x44)	30	
	0,32 / 0,0126	30 (7x38)	28	
		30 (19x42)		
	0,40 / 0,0157	28 (19x40)	26	
		27 (7x35)		
	0,51 / 0,0201	26 (19x38)	24	
		26 (10x36)		
0,64 / 0,0252	24 (19x36)	22		
	24 (7x32)			

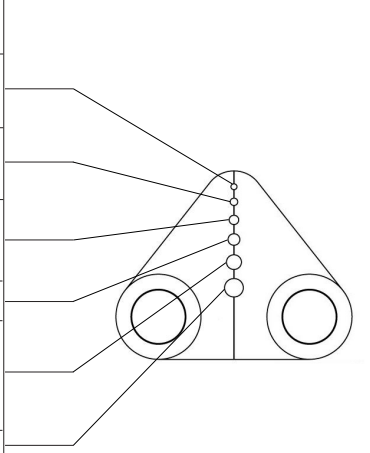
Cartridge Ref.	Tip Hole ø mm / in	AWG Stranded	AWG Solid	
W440023	0,40 / 0,0157	28 (19x40)	26	
		27 (7x35)		
	0,51 / 0,0201	26 (19x38)	24	
		26 (10x36)		
	0,64 / 0,0252	24 (19x36)	22	
		24 (7x32)		
	0,81 / 0,0319	22 (19x34)	20	
	1,02 / 0,0402	20 (42x36)	18	
20 (19x32)				
20 (7x28)				
1,29 / 0,0508	18 (19x30)	16		

Cartridge Ref.	Tip mm / in	
W440025	Flat Blade 12,5 / 0.4921	

Accessories



Maintenance

Before carrying out maintenance or storage, always unplug the stand from the station and the tool.

- Use a damp cloth to clean the stand. Alcohol can be used only when cleaning the metal parts.
- Check periodically that the metal parts of the tool/stand are clean so that the station can check the tool's status.
- Periodically check all cables and tube connections.
- Replace any defective or damaged parts. Use original JBC spare parts only.
- Repairs should only be performed by a JBC authorized technical service.



Safety

Warning

- Do not touch the blade or the metal parts around.
- Do not allow the blade be close to flammable materials.
- Keep your workplace clean and tidy. Wear appropriate protection glasses and gloves when working to avoid personal harm.
- This appliance can be used by children over the age of eight and also persons with reduced physical, sensory or mental capabilities or lack of experience provided that they have been given adequate supervision or instruction concerning use of the appliance and understand the hazards involved.
- Maintenance must not be carried out by children unless supervised.
- Place the tool on the stand when is not in use.
- Turn off the power when not in use, changing parts or storing.

Caution

- Do not use the Wire Stripper for other applications than wire stripping.
- Do not modify or customize the Wire Stripper.
- Do not hit the blade against workbench to eliminate stripped insulation debris. This behavior would damage the blade.
- Remove power from the tool by holding the plug, not the wires.
- Be careful with the fumes produced when stripping. We recomend to use our fume extractor.

Specifications

WSBT

Stand for WS140 and WS440

Ref.: WSBT-A

- | | |
|--|--|
| - Total Net Weight: | 1.30 kg / 2.86 lb |
| - Package Dimension/Weight:
(L x W x H) | 342 x 155 x 120 mm / 1.64 kg
13.46 x 6.10 x 4.72 in / 3.61 lb |

Complies with CE standards

ESD Safe

JBC

Warranty

JBC's 2 year warranty covers this equipment against all manufacturing defects, including the replacement of defective parts and labour.

Warranty does not cover product wear or misuse.

In order for the warranty to be valid, equipment must be returned, postage paid, to the dealer where it was purchased.

Get 1 extra year JBC warranty by registering here:

**<https://www.jbctools.com/productregistration/>
within 30 days of purchase.**



This product should not be thrown in the garbage.

In accordance with the European directive 2012/19/EU, electronic equipment at the end of its life must be collected and returned to an authorized recycling facility.



www.jbctools.com