

JBC

www.jbctools.com

INSTRUCTION MANUAL

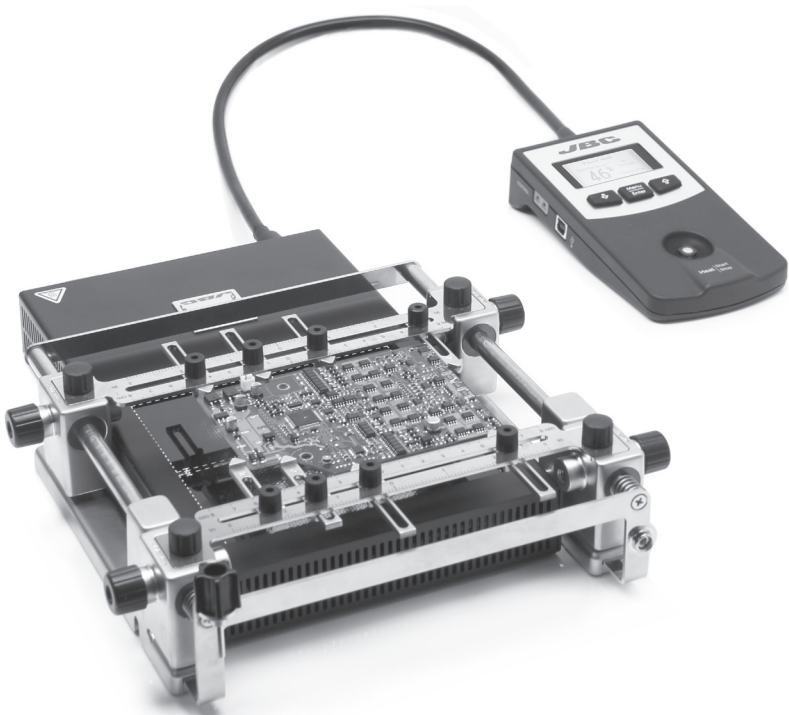

IR Preheater Set

Ref. PHS-KC

Packing List

The following items should be included:

IR Preheater 1 unit
Ref. PHS-1C (120V)
 PHS-2C (230V)
 PHS-9C (100V)

Heater Unit



Console



Convection Preheater Support 1 unit
Ref. PHS-SA

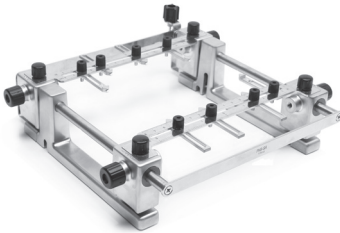

Power Cord 1 unit
Ref. 0009417 (100V/120V)
 0009401 (230V)



Kapton Tape 1 unit
Ref. PH217



Thermocouple 1 unit
Ref. PH218



Manual 1 unit
Ref. 0018633

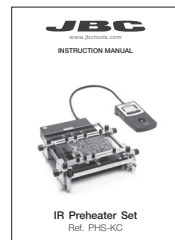

Features

Heater Unit



Console

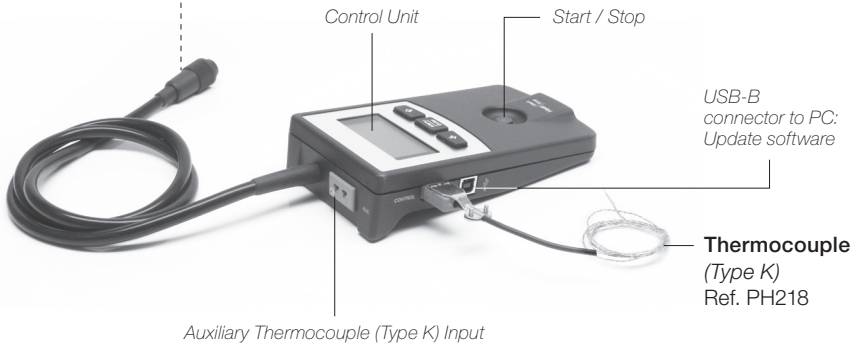

PHS-SA Features

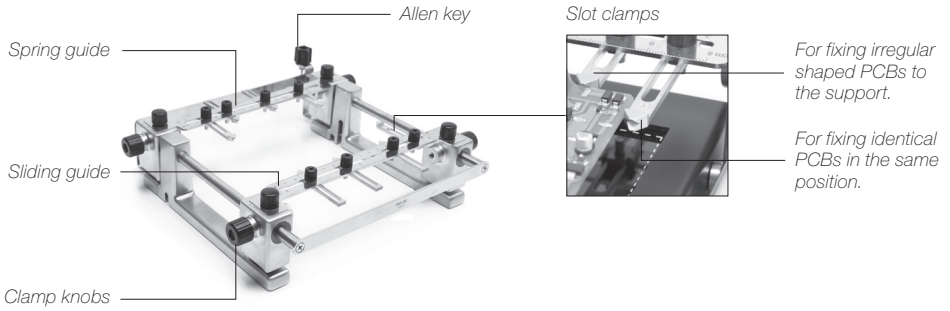

Height Adjustment

It allows adjustment for **3 heights** between the PCB and the Heating Area of the PHS-B Heater Unit.

Low level

28mm

For PCBs of 0.8 - 2.4mm thick

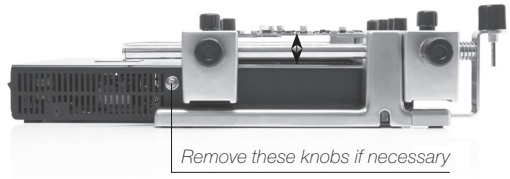

Medium level

50mm

For PCBs of 2.4 - 6mm thick

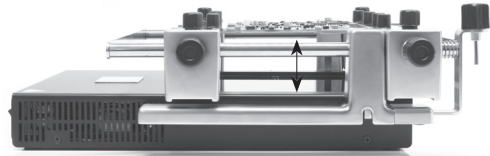

High level

70mm

For PCBs over 6mm thick

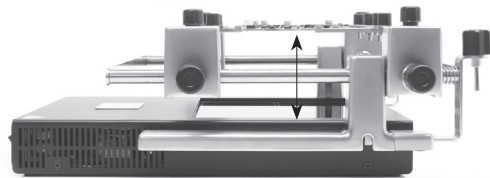

Changing PCBs of the same batch

The support lets you place PCBs of the same batch so as to always heat the same area. Use the sliding guides to change the PCBs.

Removing the PCB

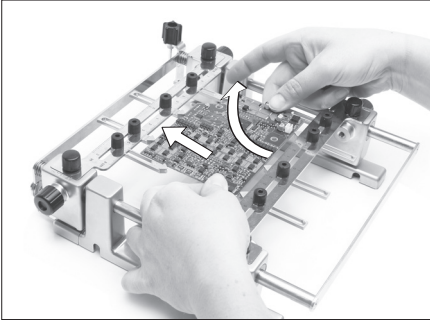

After loosening the SP guide knobs, push the PCB against the SP guide and lift out.

Placing another PCB

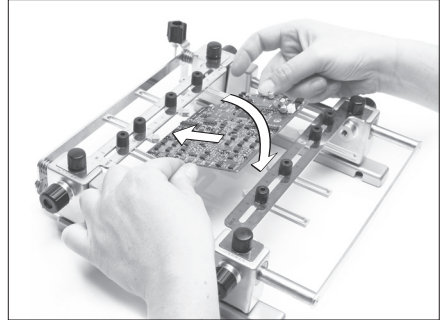

Push the PCB against the SP guide, position it and tighten the SP guide knobs.

Reworking large PCBs

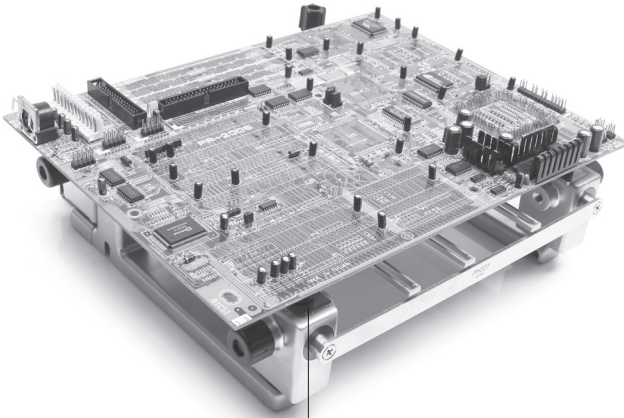

Place large PCBs on the 4 rubber cups



Positioning PHS on RWS

The position of the PHS can be fixed on the RWS by means of positioning caps.

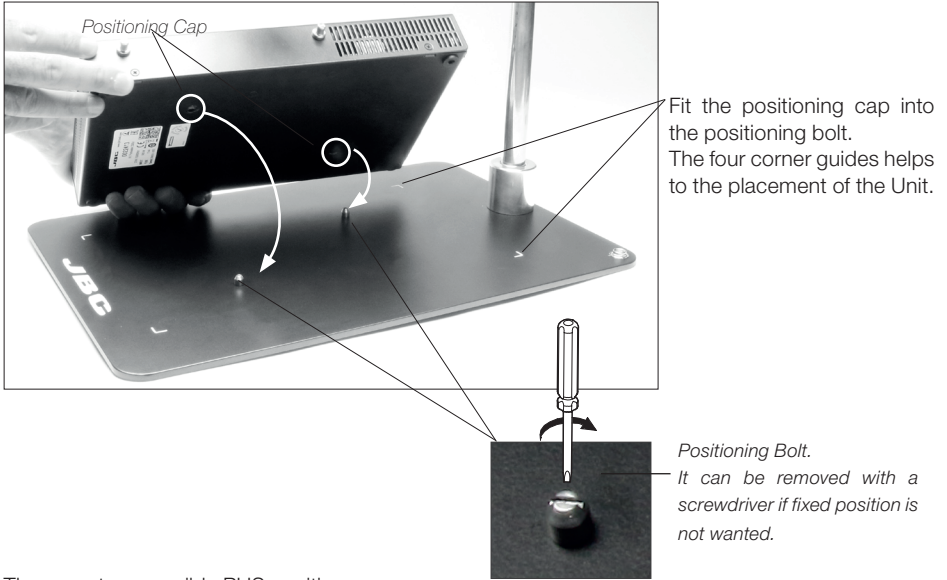

There are two possible PHS position.



Notes

Operation

Why Infrared? The most efficient technology for PCB preheating

This is the most advanced, efficient and cost-effective method to preheat PCBs in any soldering job or rework job. The low thermal mass of the infrared element gives outstanding control of the heat output and the process temperature. This technology provides fast response, high heating rates and uniform heating that ensure the best results.

Profiles by Temperature

The usual way to run a profile is using the Thermocouple (TC) connected to the Control Input of the console. JBC offers 3 predefined profiles (JBCset) and 10 profiles ready for you to personalize.

JBCset profiles

There are 3 profiles predefined by JBC: A, B and C. The difference between them is the number of steps: 2, 3 or 4. The thicker your PCB is and the more layers it contains, the more steps are needed to obtain a gradual warming.

These profiles are not modifiable but they can be used as a template to create your own profiles.

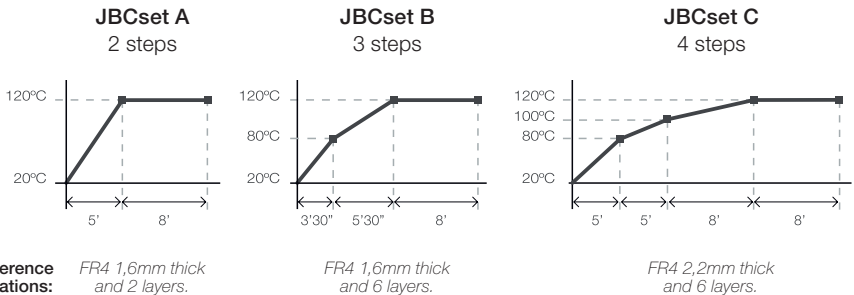

Profiles set using the low position of the PHS-SA Support (28 mm in height between the PCB and the heating area).

User profiles

You can create your own profiles from the JBCset profiles. On the work screen of the profile, press the *Enter* button and choose the option *Edit profile*.

For repetitive jobs **we recommend** running profiles without the Thermocouple (TC). Once any profile has been run to the end, the system has all the process data which you can save. Once it is saved, you can run this profile without connecting the Thermocouple (TC). The heating process will be the same as long as the same working conditions are respected.

Power Mode

The unit works at the selected power or temperature during the defined time. These parameters can be modified from the work screen by pressing the *Enter* button and the *Edit parameters* menu.

To see the current temperature you must plug the Thermocouple (TC) into the Control connector.

Recommended Guidelines

1. Place the Thermocouple (TC) as near as possible to the component being worked on.

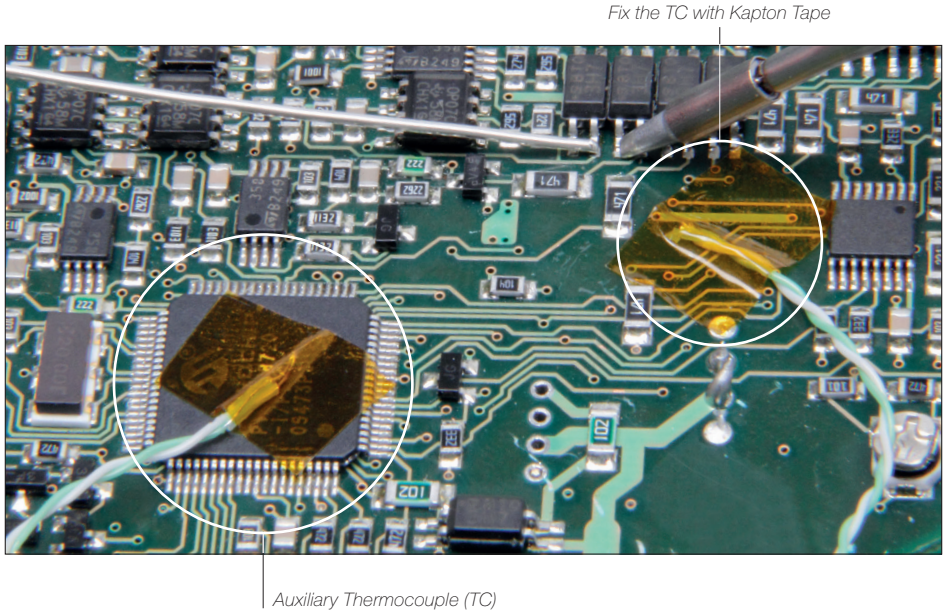

2. If there are any sensitive components, use the Auxiliary Thermocouple as protection. You can select the protection temperature in *Station settings*. If the selected temperature is reached, the Heater Unit will stop the process and a warning message will be shown.
3. IPC* does not recommend exceeding ramp-up rates over 3 - 4 °C / sec (5 - 7 °F / sec) so as to reduce the risk of thermal stress on the PCB.

* IPC was founded in the U.S. in 1957 as the Institute for Printed Circuits and is committed to becoming the most recognized international industry association for the electronics manufacturing industry.

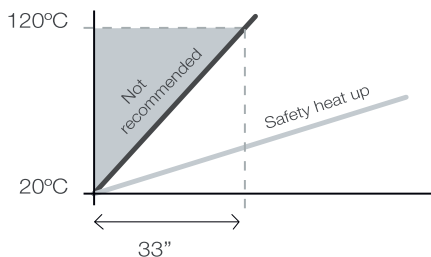

Display Control

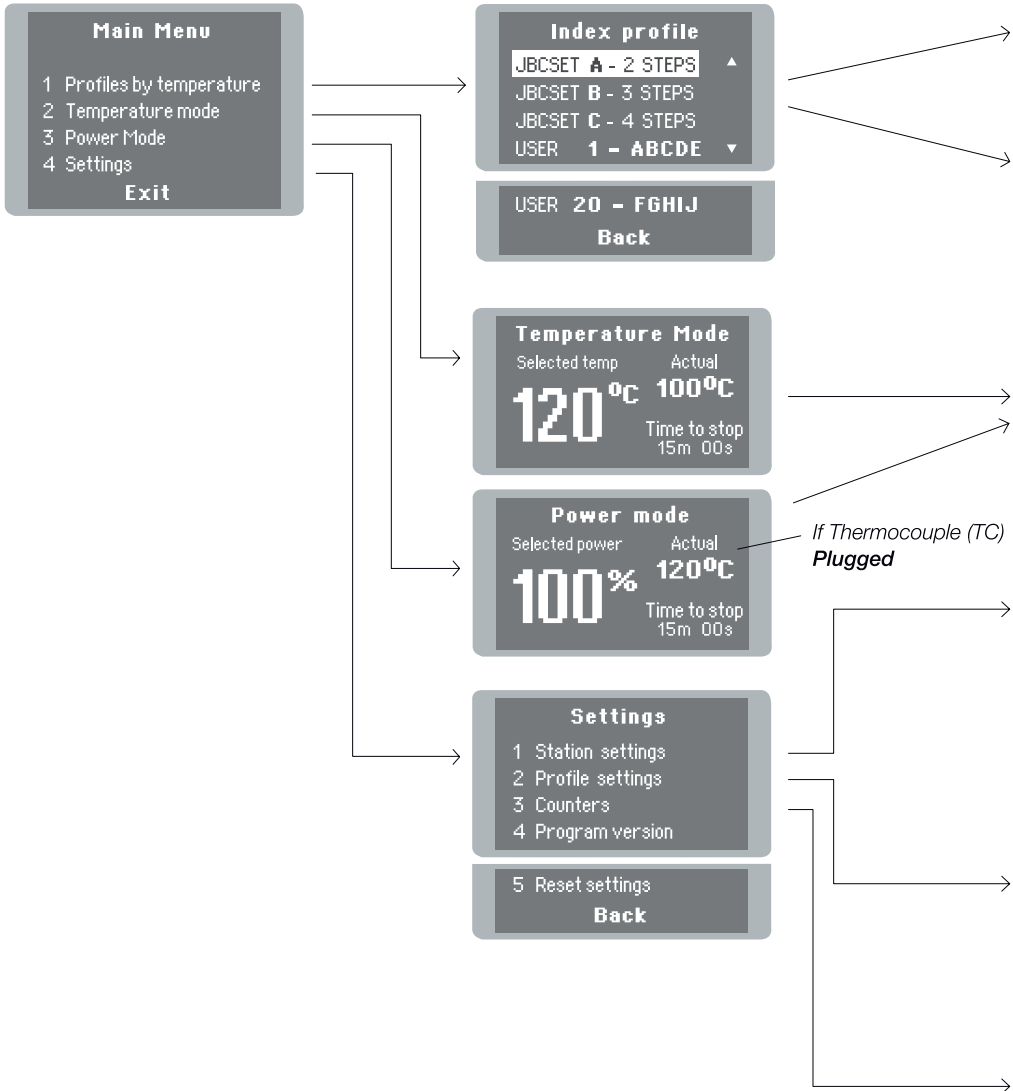

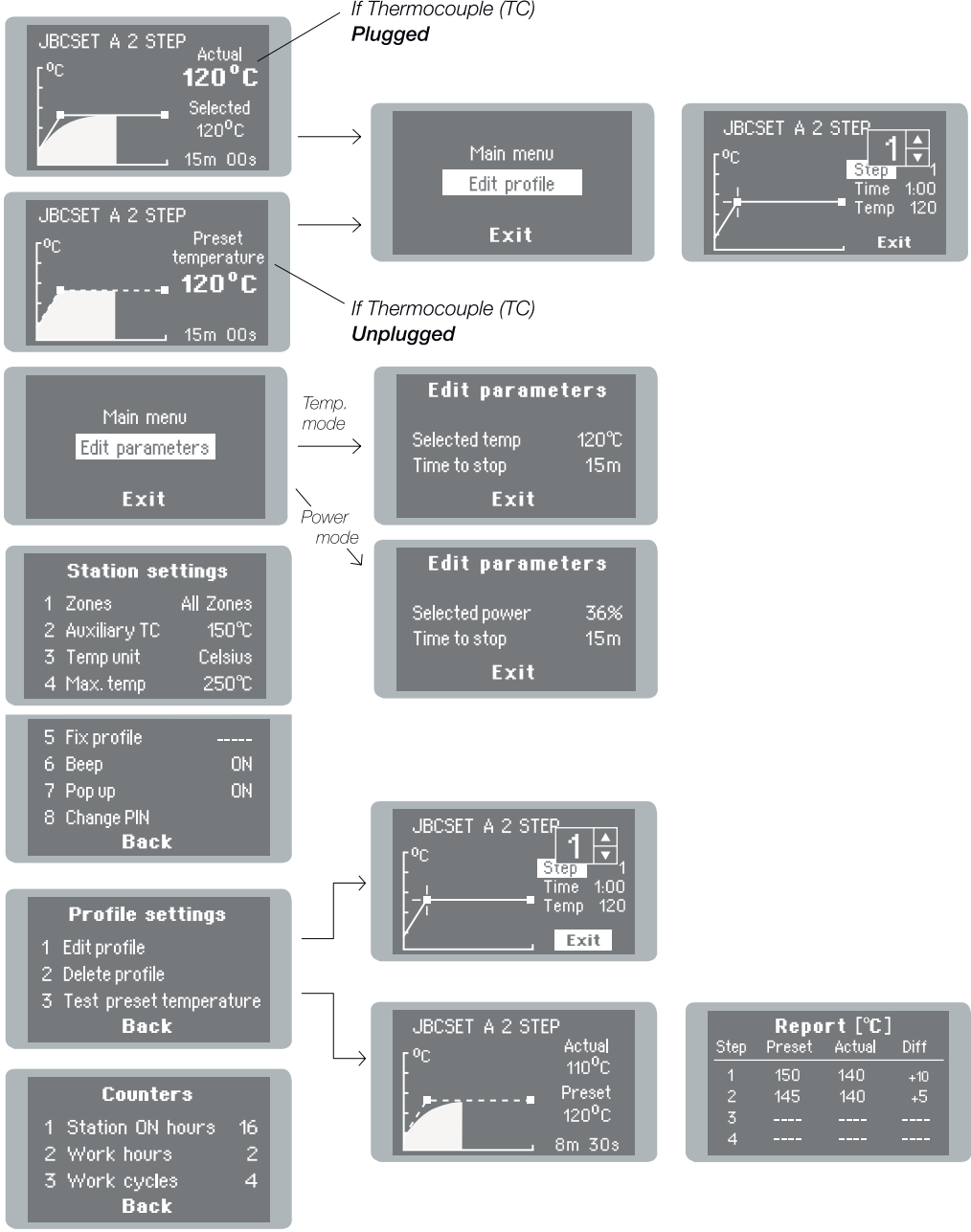

Maintenance

Before carrying out maintenance or storage, always allow the equipment and the support to cool.

- Check periodically that the PHS-KB is clean.
- Use a damp cloth when cleaning. Alcohol can only be used to clean the metal parts.
- Only if it is absolutely necessary and if cleaning with isopropyl alcohol (IPA) is not enough, it is recommended to use a scraper to remove dirt in the glass area.
- Replace any defective or damaged parts. Use original JBC spare parts only.
- Repairs should only be performed by a JBC authorized technical service.



Safety



It is imperative to follow safety guidelines to protect health and prevent electric shock, injury, fire or explosions.

- Do not use the units for any purpose other than PCB preheating. Incorrect use may cause fire.
- The mains cable must be plugged into approved bases. Make sure that it is properly grounded before use. When unplugging it, hold the plug, not the wire.
- The temperature of accessible surfaces may remain high after the unit is turned off. Handle with care.
- Do not leave the appliance unattended when it is on.
- Do not cover the ventilation grills. Heat can cause inflammable products to ignite.
- Heat can cause inflammable products to ignite even when out of sight.
- Be careful with the remains of liquid tin. In contact with skin, it can cause burns.
- Avoid flux coming into contact with skin or eyes to prevent irritation.
- Be careful with the smoke produced when soldering.
- Keep your workplace clean and tidy. Wear appropriate protection glasses and gloves when working to avoid personal harm.
- This appliance can be used by children over the age of eight as well as persons with reduced physical, sensory or mental capabilities or lacking experience provided that they have been given adequate supervision or instruction concerning use of the appliance and understand the hazards involved. Children must not play with the appliance.
- Maintenance must not be carried out by children unless supervised.

Exploded View

PHS-1KC 120V
PHS-2KC 230V
PHS-9KC 100V
IR PREHEATER SET

0022195
0022198

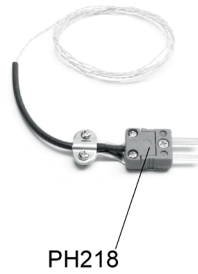
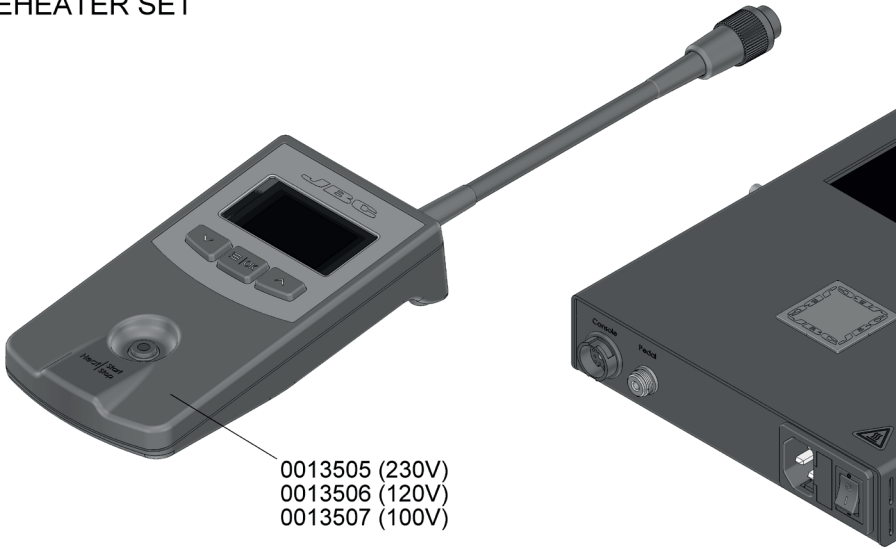

(230V)
(100V, 120V)

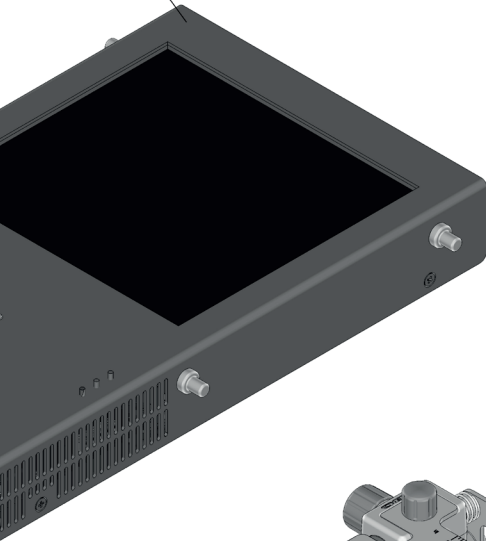

SPARE PARTS

HEATER UNIT:

-CIRCUIT (230V):	0012978
-CIRCUIT (100V, 120V):	0013225
-LAMP (230V):	0016585
-LAMP (100V, 120V):	0016586
-GLASS:	0016609
-ENCLOSURES:	
· TOP	0013449
· BOTTOM	0022115

PHS-1KC 120V FUSE T-8A
PHS-2KC 230V FUSE T-4A
PHS-9KC 100V FUSE T-8A

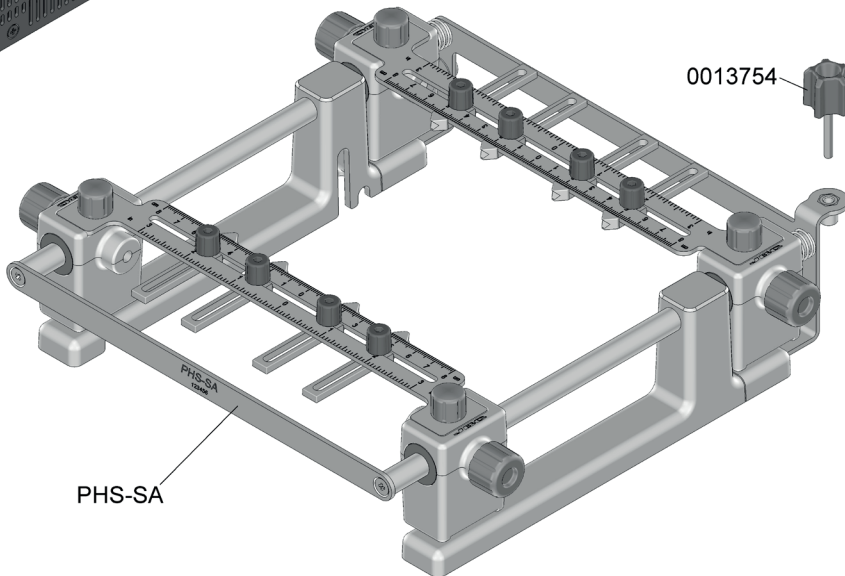

Specifications

IR Preheater Set

PHS-1KC / PHS-2KC / PHS-9KC

- Total weight: 4,9 kg (10.8 lb)
- Ambient operating temperature: 10 - 40 °C (50 - 104 °F)

PHS-1C 120V. Input 120V 50/60Hz Fuse 8A

PHS-2C 230V. Input 230V 50/60Hz Fuse 4A

PHS-9C 100V. Input 100V 50/60Hz Fuse 8A

- Weight: 2,9 kg (6.39 lb)
- Dimensions (Heater Unit): 195 x 288 x 41,5 mm (7.68 x 11.34 x 1.63 in)
- Maximum Power: 500W
- Heating Area: 65 x 135 mm (2.56 x 5.31 in - 1 zone)
130 x 135 mm (5.12 x 5.31 in - 2 zones)
- Temperature Range: 50 - 250 °C (120 - 482 °F)
- Temperature Measurement: Thermocouple type K
- JBCset temperature profiles: 3 profiles (2, 3 or 4 steps)
- User Profiles: 20 (up to 6 steps for each)
- Maximum work time: 600 min or indefinite

PHS-SA

- Weight: 2 kg (4.4 lb)
- Dimensions (Low Position): 267 x 259 x 75 mm (10.5 x 10.2 x 3 in)
- Dimensions (High Position): 267 x 259 x 96 mm (10.5 x 10.2 x 3.8 in)

Complies with CE standards.

ESD protected housing.

JBC

Warranty

JBC's 2 year warranty covers this equipment against all manufacturing defects, including the replacement of defective parts and labour. Warranty does not cover product wear or misuse. In order for the warranty to be valid, equipment must be returned, postage paid, to the dealer where it was purchased. Please register your product warranty within 30 days of purchase in www.jbctools.com/productregistration.



This product should not be thrown in the garbage.

In accordance with the European directive 2002/96/EC, electronic equipment at the end of their life must be collected and returned to an authorized recycling facility.



Manual in other languages available on our website

www.jbctools.com