

JBC

www.jbctools.com

Page

English

3

Español

37



Premium Complete Rework station with Pneumatic Pump

Ref. RMVE-C

Index

Packing list4

JT Hot Air station

Features8
Adjustable Stand9
Quick Nozzle Changer10
Protectors & Extractors11
T260 Pick & Place12
Operation & Process Control with JT13
JT-TA Replacing the Heating Element16
JT-TA Changing the Heater Hose Set17

DDE Control Unit & MVE Module

Features18
Adjustable Stand20
Tip Cleaner21
T245 Changing Cartridges22
DR560 Changing Tips23
DR560 Changing the Heating Element ...24
DR560 Tin Deposit Cleaning25
DR560 Tip Care26
Desoldering Process DDE & MVE26
MVE Initial Setup27
MVE Changing the pump filters27
Removing the pneumatic tubing27
Operation with DDE28
Process Analysis30
Soldering Net31
Working with robots32
Station Software32

Maintenance33

Safety34

Specifications35

Exploded View70

Packing List

The following items should be included:

JTE Control Unit 1 unit
Ref. JTE-1D (120V)
JTE-2D (230V)
JTE-9D (100V)



DDE Control Unit 1 unit
Ref. DDE-1B (120V)
DDE-2B (230V)
DDE-9B (100V)



Pneumatic Desoldering Module 1 unit
Ref. MVE-A



Stand 1 unit
Ref. JT-SD



Stand 1 unit
Ref. AD-SD



Stand 1 unit
Ref. DR-SD



Heater hose set 1 unit
Ref. JT-T1A (100V / 120V)
JT-T2A (230V)



General Purpose Handle 1 unit
Ref. T245-A



Desoldering Iron 1 unit
Ref. DR560-A



Extractor stand* 1 unit
Ref. 0008752

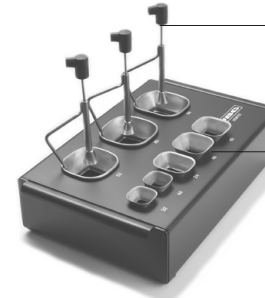

Tip Cleaner 1 unit
Ref. CL9885



Cartridges 2 units
Ref. C245903 (x1)
C245906 (x1)



Extractors*
Ref. E2184
E2064
E2052

Protectors*
Ref. P2220
P2230
P2235
P4000
P4010

Suction Cups*
Ref. 0930110
Ø 10 - 0934050 (x3)
Ø 4.7 - 0934070 (x1)



Tripod*
Ref. T2050 (Ø 39mm)
T2250 (Ø 85mm)



Suction Tube*
Ref. 0932330



Nozzles
Ref. JN2015 (x1)
JN2012 (x1)
JN2020 (x1)

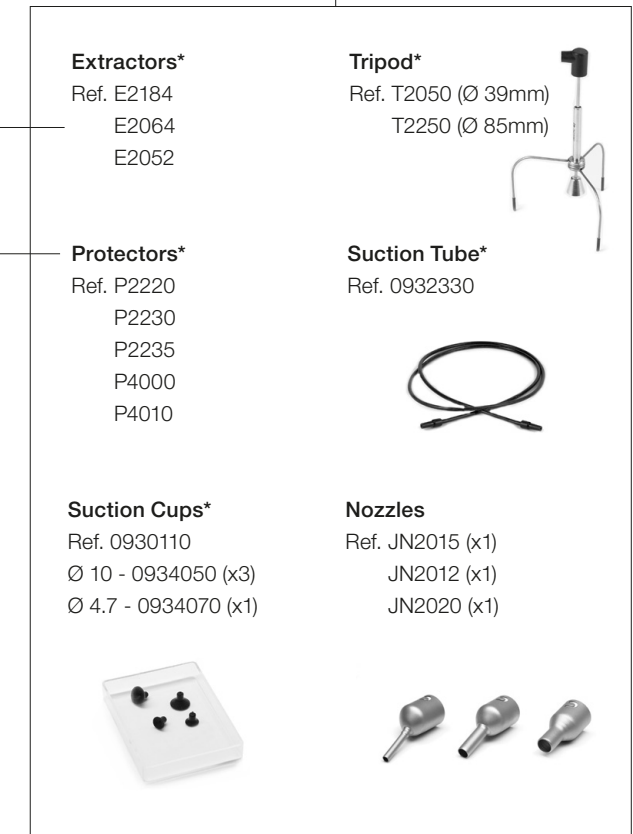





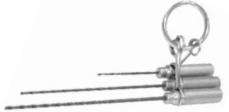

JT Accessory set
Ref. 0012332

* These accessories are not supplied with JT-2QC / JT-1QC / JT-9QC stations.

DR560 Accessories

Ref. 0010211

<p>Tip cleaning set 1 unit Ref. 0965970</p> 	<p>Long Tip Cleaning set 1 unit Ref. 0965760</p> 	
<p>Tips 3 units Ref. C560005 C560013 C560004</p> 	<p>Tin deposit 1 unit Ref. 0812620</p> 	<p>Spanner 1 unit Ref. 0780550</p> 
<p>Filter Box 1 unit Ref. 0780840 <i>It contains 10 filters</i></p> 	<p>Internal gasket 2 units Ref. 0812360</p> 	<p>Metal tin deposit 1 unit Ref. 0812630</p> 

<p>Cotton Filter 1 unit Ref. 0781046 <i>It contains 10 filters</i></p> 	<p>Filter Box 1 unit Ref. 0005966 <i>It contains 50 filters</i></p> 	<p>Suction Filter 1 unit Ref. 0821830</p> 
---	--	--

Pick & Place 1 unit
Ref. T260-A



Bent Needles Set 1 unit
Ref. 0861660



Straight Needles Set ... 1 unit
Ref. 0901546



Cups Set 1 unit
Ref. 0940163



Cleaning stick 1 unit
Ref. 0786640



Stand Cable 2 units
Ref. 0011283



Module Cable 1 unit
Ref. 0014874



Union Flanges 1 unit
Ref. 0011356



Escape Filter 1 unit
Ref. 0008446



Power cords
For DDE 1 unit
Ref. 0013671 (100/120V)
0010569 (230V)



For JTE 1 unit
Ref. 0009417 (100V/120V)
0009401 (230V)



Manual 1 unit
Ref. 0017358

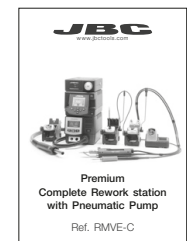

JT Features

USB-B connector

Update the station software from the JBC website

Activates the suction pump



Suction Tube

Ref. 0932330
For tripods and extractors

Another connectable tool:

Precision Heater hose set

Ref: TE-TB

Heater Hose set

Ref. JT-T1A (100V/120V)
JT-T2A (230V)

Heating element

Hot Air button (On / Off)



Stand

Ref. JT-SD

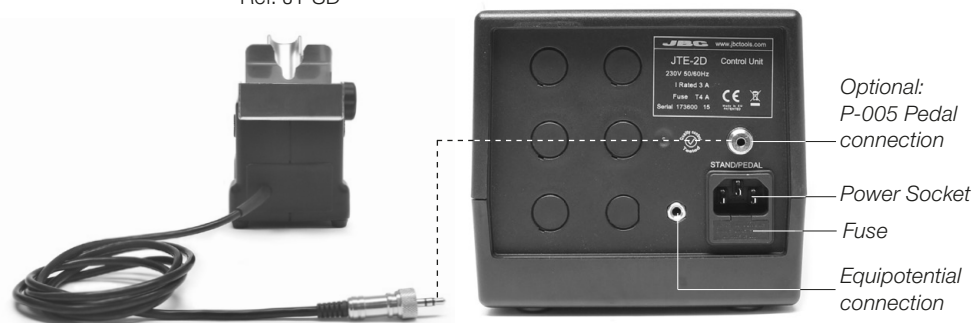

Optional: P-005 Pedal connection

Power Socket

Fuse

Equipotential connection

Adjustable Stand

Adjust the tool holder angle to suit your work position.



Operation Modes

1. From the main Menu, select the mode to activate the tool depending on the task.

Stand + Autostart OFF



Press the start/stop button to blow hot air.

Stand + Autostart ON



The tool automatically starts blowing hot air when lifted from the stand.

Pedal*

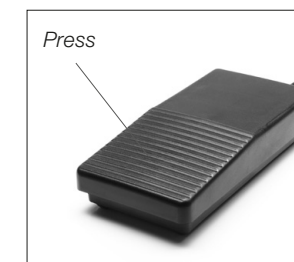

Press the Pedal to blow hot air and release to stop.

*The P-005 Pedal is not supplied with this station. See our website.

2. The tool stops blowing hot air when returned to the stand.



Quick Nozzle Changer

Changing nozzles quickly and safely.

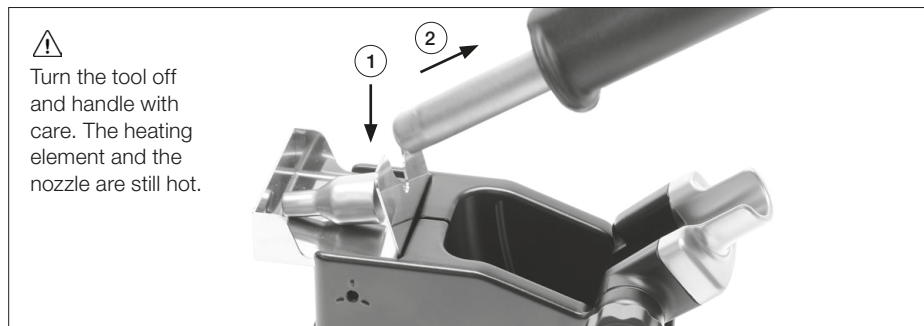

⚠
Turn the tool off and handle with care. The heating element and the nozzle are still hot.

Compatible Nozzles

The JT-TA works with JT nozzles. Find the model that best suits your soldering needs in www.jbctools.com

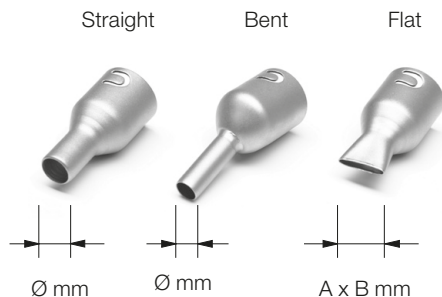

Ref.	Shape	Size
JN2020	Straight	Ø 8mm
JN8417	Straight	Ø 10mm
JN2015	Bent	Ø 4mm
JN2012	Bent	Ø 6mm
JN6633	Bent	Ø 8mm
JN7637	Flat	10 x 2mm
JN7638	Flat	20 x 2mm
JN7639	Flat	30 x 2mm

In case of a loosely fitting nozzle:

1. Push the nozzle tab inwards with a screwdriver or flat-nosed pliers.

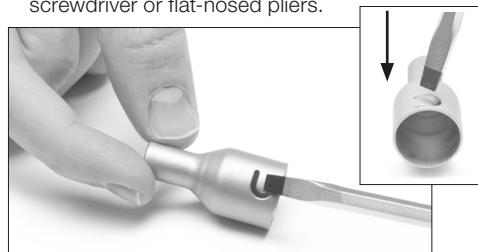

2. Insert the nozzle into the JT-TA Heater again.

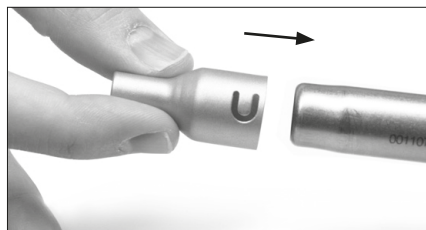

Protectors & Extractors

For small components (fig. 1 and 2).

We recommend using the protector + tripod

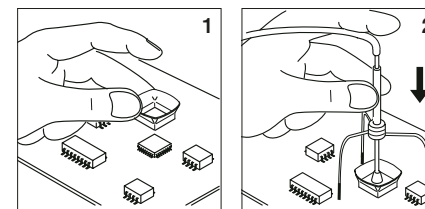

Protectors

* Ref.	AxB (mm)	* Ref.	AxB (mm)
P3353	4,3 x 3	48 P2230	15 x 15
P3786	5,2 x 5,2	60 P4010	17 x 17
P3352	5,2 x 7,5	P4005	18 x 29
P3355	5,2 x 9,5	P4030	18,5 x 18,5
P3356	6,2 x 4,2	P1068	18,5 x 24
P3785	7,2 x 7,2	P2685	28,5 x 28,5
P3784	8,2 x 8,2	P4085	31,5 x 31,5
P4035	9 x 13	P2672	33 x 46
P4040	9,5 x 19	P4002	50 x 50
P4080	9,5 x 21	P3357	52,5 x 14
32 P2220	10 x 10		
P4045	10,5 x 21		
P4090	11 x 16		
24 P2235	12 x 17		
P1249	12 x 23		
44 P4000	12,5 x 12,5		
P3354	13,2 x 13,2		
P4025	13,5 x 21,5		

* Reference Desk

For big components (fig. 3 and 4).

We recommend using the extractors

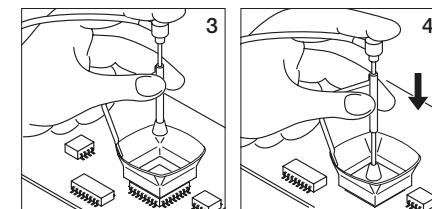

Extractors

* Ref.	AxB (mm)	* Ref.	AxB (mm)
52 E2052	20 X 20	E2124	45 X 45
64 E2064	20 X 26		
80 E2184	24 X 24		
E2068	27 X 27		
E4020	28,5 X 28,5		
E4015	31,5 X 31,5		
E2084	33 X 33		
E2100	38 X 38		

Tripods

* Ref.	øC (mm)
T2050	39
T2250	85

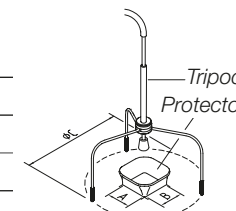

Manual extractor

* Ref.	øD (mm)
E2190	7



T260 Pick & Place

This tool helps you easily place and remove SMDs of any size using the suction provided by the station.

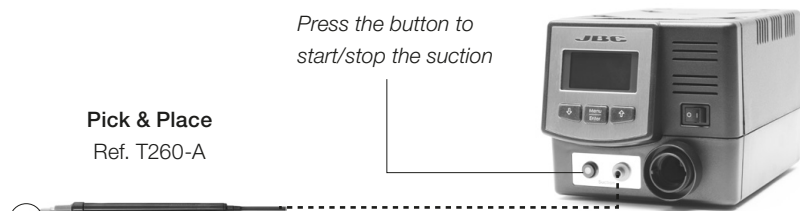

Pick & Place
Ref. T260-A

Choose the **suction cup** that best fits the component (Maximum working temp.: 250°C / 482°F):

Insert the needle with the appropriate cup for a correct suction process.

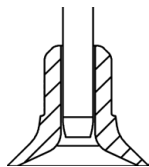

You should avoid the needle to stick out of the lower part.

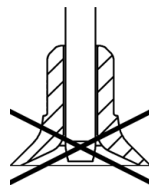

Operation

1. Suction

Once activated the suction button, cover the pen hole with your finger and pick the component.

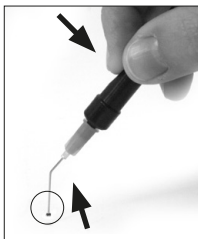

2. Release

Lift your finger to release the component on the appropriate place.

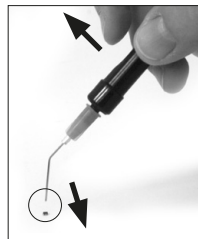

Operation with JT station

1. Placing

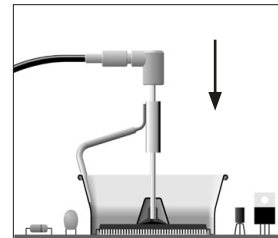

Position the suction cup.

2. Heating

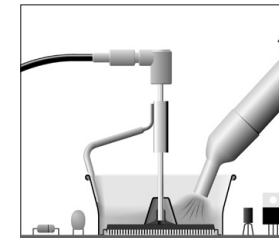

Push the button for hot air heating. The solder melts.

3. Releasing

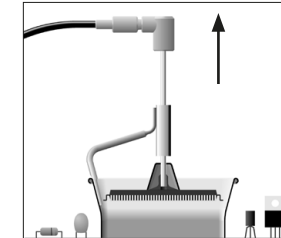

The component lifts off automatically.

Process Control

Manual mode

Time to stop 45 seconds
Temp °C 400 | Air % 85
Selected temperature 400°C Select
Power 70%

Current temperature — 400
Selected temperature — 400°C Select
Power 70%

% Instant power supplied to heater

Access Menu (press key 2 seconds) & Confirm Selection

You can switch between operating modes (Manual Mode / Profile Mode) by pressing the "increase" and "decrease" keys simultaneously for 2 seconds. (Only when mode profiles is ON)

Program mode

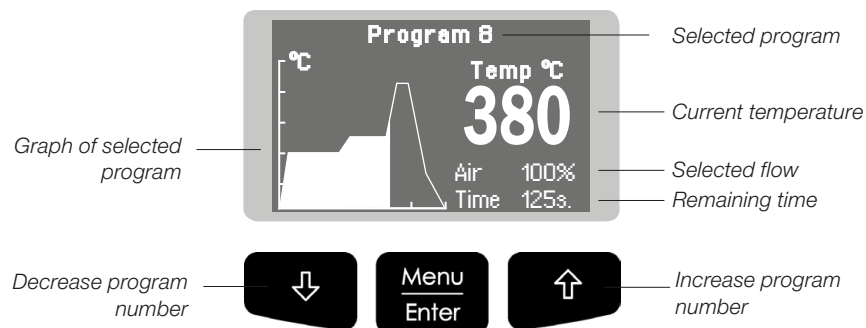

Program Options

Edit Program

This option allows you to edit or create a program.

First, you must select the program to edit and then modify the points that make up the program.

Each program is composed of 9 points, each point consisting of 3 parameters:

1. Time (seconds)
2. Temperature (°C / °F)
3. Flow rate (%)

You can delete the last point of the program by selecting "-----" in the time parameter.

It should be taken into account that the regulation range permitted by the station is 150-450°C, whereby it is not possible to create temperature ramps between room temperature (Toff) and 150°C.

The station can store up to 25 temperature programs.
The first three programs are edited by JBC as an example.

Copy Program

This option allows you to copy a program.

You must select the program source and the program destination (where it will be copied).

Delete Program

This option will allow you to delete a previously selected program.

Menu screen

Original PIN: 0105

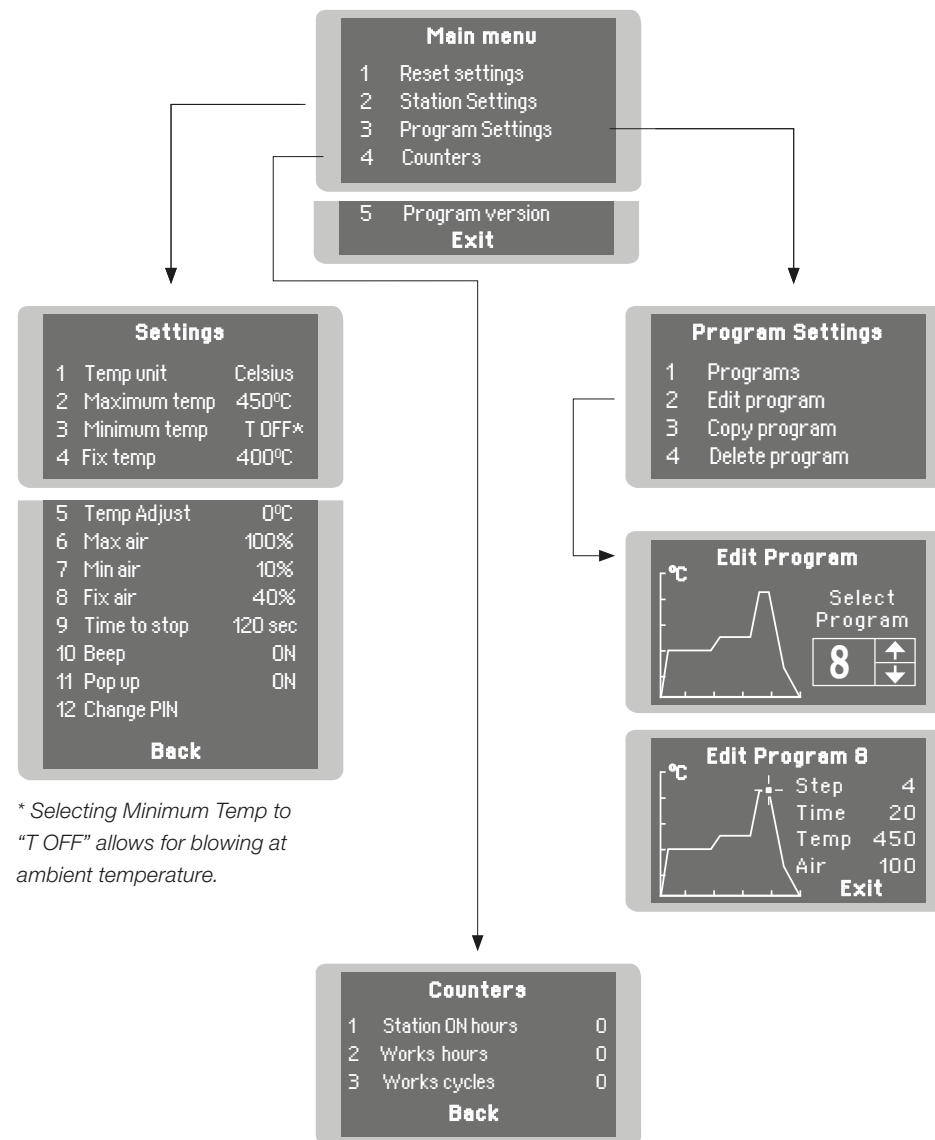

* Selecting Minimum Temp to "T OFF" allows for blowing at ambient temperature.

JT-TA Replacing the Heating Element

Only perform this operation when the element is cold and the unit is disconnected from the mains.

1. Loosen the screw.
2. Pull the heating element away from the handle.
3. Connect the new heating element, ensuring its pushed all the way in.
4. Tighten the screw.

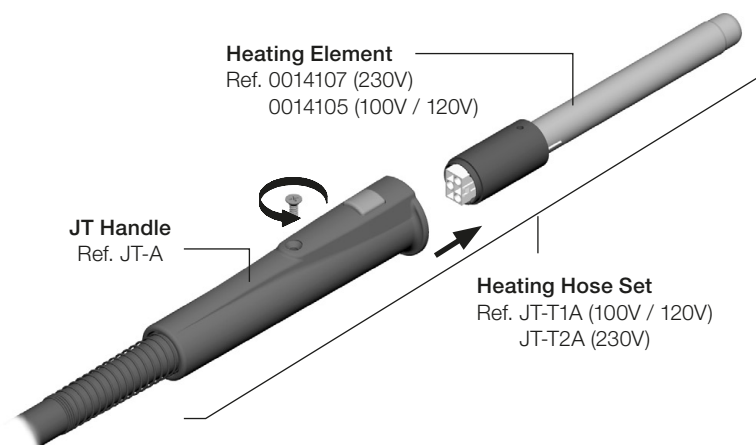

JT-TA Changing the Heater Hose Set

1. Ensure that the tool is turned off.
2. Use a spanner to unscrew the connecting nut.
3. The tube end of the new heater must be inserted so that the longitudinal rib fits into the groove.
5. Follow the same steps conversely.



DDE & MVE Features

Work simultaneously with **up to 2 tools** and join each station port with **1 module + 1 pedal** (Peripherals).

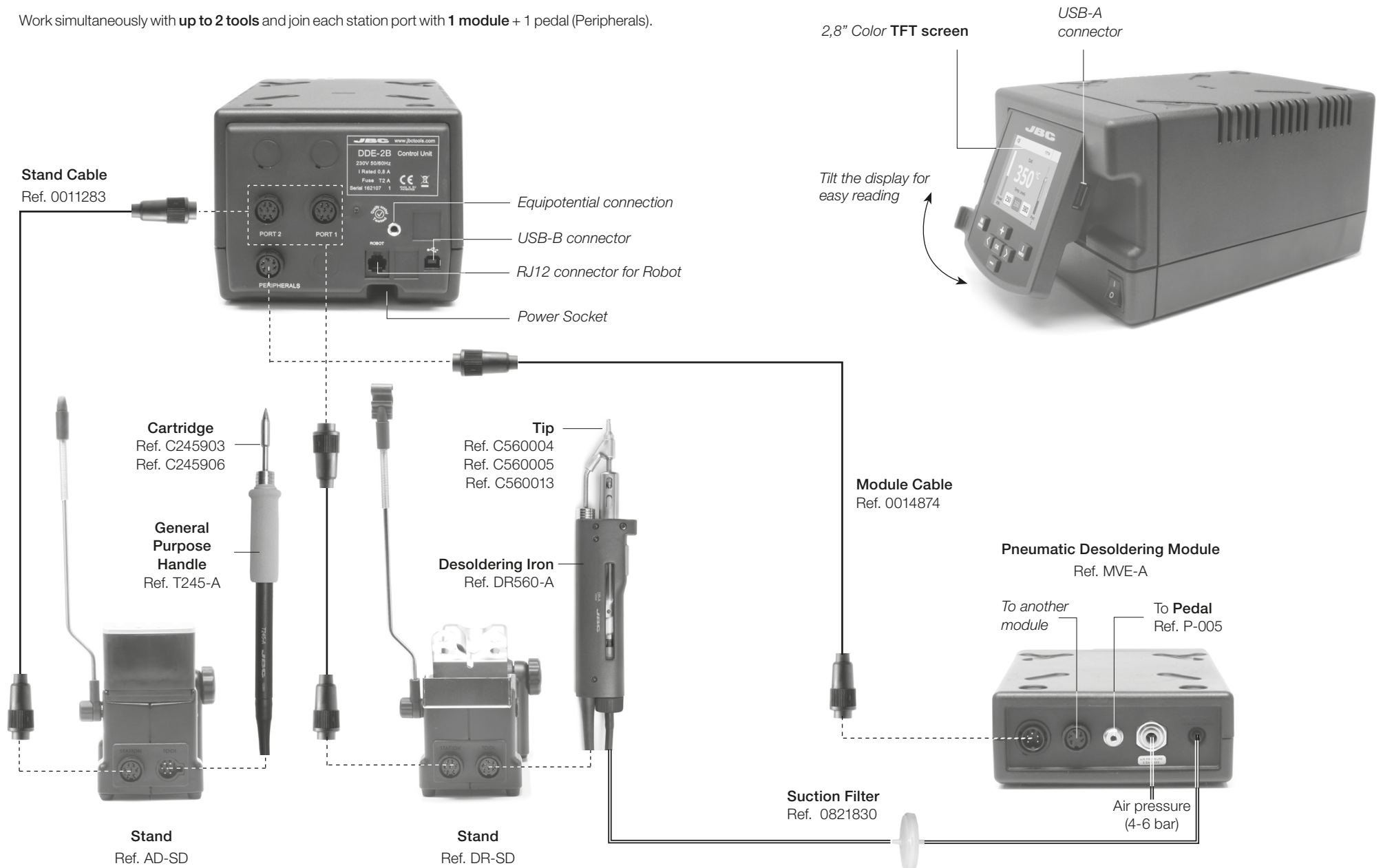

Adjustable Stands

Cable collector
Keeps working area free of cable.



Quick tip changer
Permits switching cartridges without interrupting your work.



Stand
Ref. AD-SD

Quick tip changer
Holding tip system for easy change.



Stand
Ref. DR-SD

Adjustable tool holder
Suits your work position.



Adjustable cable collector

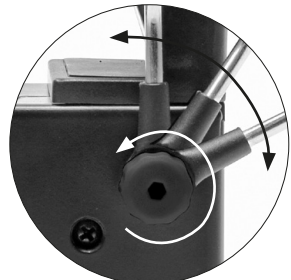

Tip Cleaner

Improve thermal transfer by cleaning the tip after each solder joint.

Brass wool

Ref. CL6210
Very effective cleaning method. It leaves a small layer of solder on the tip to prevent oxidation between cleaning and rewetting.

Sponge

Ref. S0354
The least harmful cleaning method. Keep the sponge damp with distilled water when working to avoid tip wear.

Splashguard

It prevents splashing of solder particles when using the brass wool.

Wiper

Ref. CL0236
A temperature resistant receptacle lets the operator remove excess solder by gentle tapping or wiping. It can be easily removed for cleaning.



Tapping:

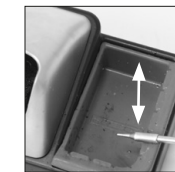

Tap gently to remove excess solder.

Wiping:

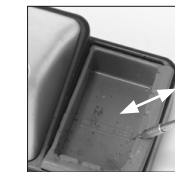

Use the slots to remove remaining particles.

Maintenance

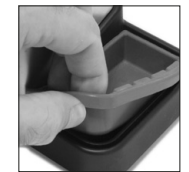

It can be easily removed for cleaning.

Optional

Inox wool

Ref. CL6205



Brushes

Ref. CL6220



Tip-tinner

Ref. TT-A



Sand

Ref. CL6211



T245 Changing Cartridges

Save time and change cartridges safely without switching the station off.

1. Removing

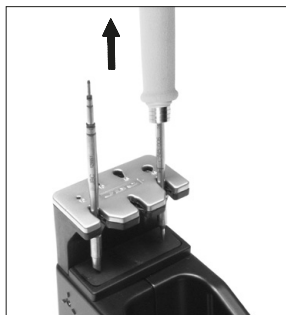

Place the handle in the extractor and pull to remove the cartridge.

2. Inserting

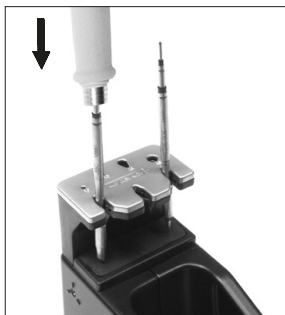

Place the handle on top of the new cartridge and press down slightly.

3. Fixing

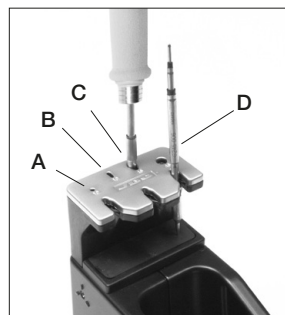

Use the holes for fixing the cartridge* as follows:

- A. For straight C210.
- B. For curved C210.
- C. For curved C245.
- D. For straight C245.

*Important

It is essential to insert the cartridges as far as the mark for a proper connection.

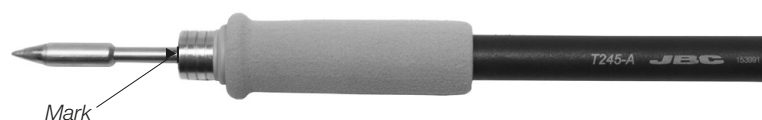

Compatible cartridges

The T245 handle works with C245 cartridges. Find the model that best suits your soldering needs in www.jbctools.com

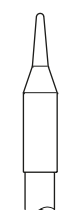

Round

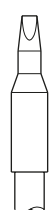

Chisel



Round bent



Bevel

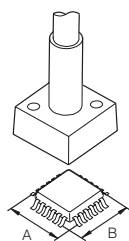

Special models

DR560 Changing Tips

This operation should be done while the tip is hot, not below 250°C, so that any tin left inside is in molten state.

1. Removing

Unscrew the tip using the spanner supplied.

2. Inserting

Fit the new tip and tighten with the spanner to make sure it is air tight.



Compatible Tips

The DR560 works with C560 tips. Find the model that best suits your soldering needs in www.jbctools.com
Here are some C560 tips in real size (mm):

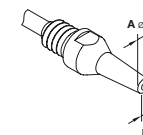

C560-001 ØA=1,4 ØB=0,6 Ømax. pin=0,4

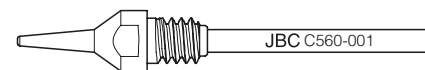

C560-002 ØA=1,8 ØB=0,8 Ømax. pin=0,6

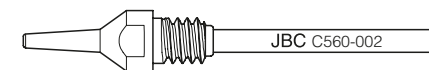

C560-014 ØA=2,5 ØB=0,8 Ømax. pin=0,6

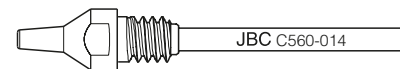

C560-003 ØA=2,7 ØB=1 Ømax. pin=0,8

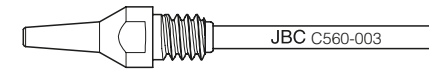

C560-004 ØA=3,2 ØB=1,3 Ømax. pin=1,1

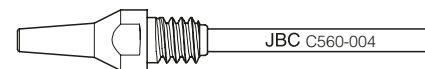

C560-009 ØA=5 ØB=1,3 Ømax. pin=1,1

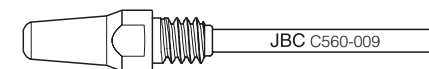

DR560 Changing the Heating Element

To perform this operation, turn off the station or disconnect the tool.

1. Loosening

The deposit lid needs to be loosened.



2. Removing

Loosen the screw as shown and remove the Heating Element.



3. Placing

Place the new Heating Element and follow the steps conversely.

Important

For a proper connection it is essential to insert the cartridge by lining it up to the mark ►|.



DR560 Tin Deposit Cleaning

1. Removing the lid

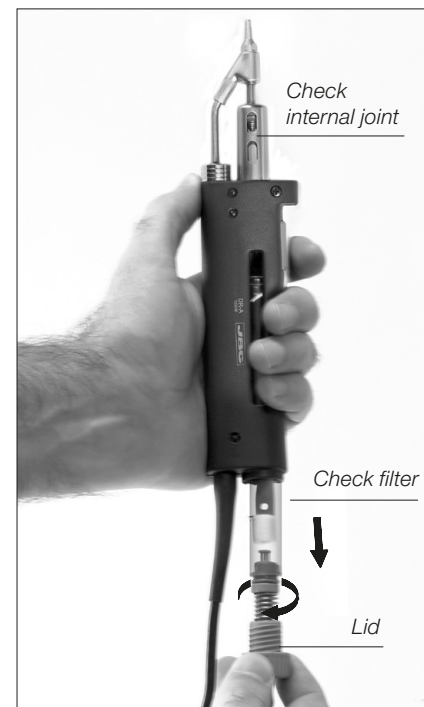

The lid must be removed with the DR560 in vertical position.

3. Inserting the deposit

The deposit must be inserted with coil filter in place, positioned between the 2 lines marked on the tin deposit.

Then the whole unit must be closed by screwing the lid.

2. Cleaning

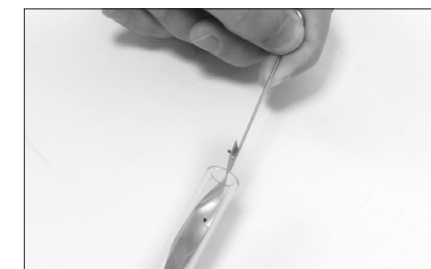

Remove the coil to clean the inside of the deposit with the stick supplied.



The filter and internal joint must be checked and replaced if dirty or damaged.



DR560 Tip Care

The intake tube should be periodically cleaned by the largest rod.



Important

DO NOT press the vacuum pump button while tinning the desoldering tip, as the fumes given off by the flux would quickly block the ducts and the air filter.

Desoldering process

Use a tip with a larger diameter than the pad to achieve maximum aspiration and thermal efficiency.

1. Placing

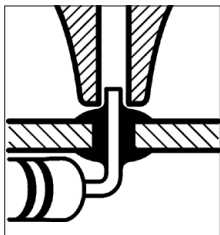

Place the tip with the component terminal in the hole.

2. Rotating

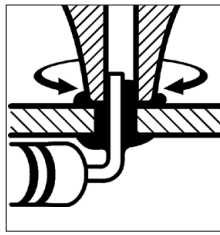

When the solder liquefies, gently rotate the tip so that the component terminal can be lifted off.

3. Aspirating



Press the vacuum pump button long enough to remove the solder.

After pressing the desoldering key there is a slight delay until the self-contained vacuum pump stops. This makes sure that the vacuum circuit is completely empty. If any solder remains are left on a terminal after desoldering it, resolder it with fresh solder and repeat the desoldering operation.

MVE Initial Setup

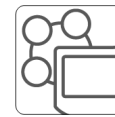

After connecting the pneumatic desoldering module (MVE-A), enter the **Peripherals** Menu and select the port which you want to join with the module.

Peripherals

1. Select the module from the list of peripheral connections. Remember your first connection is denoted as "a", the second being "b", etc. (e.g. MVE_a, MVE_b,...)

2. Press Menu or Back to save changes. Once set up, you can change the module settings by entering the **Peripherals** Menu.

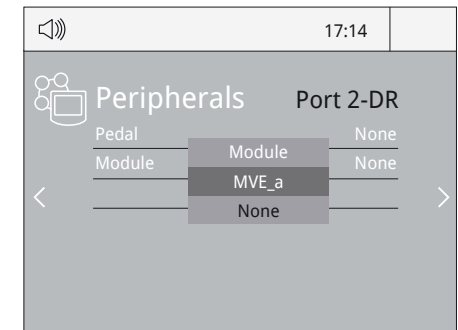

MVE Changing the pump filters

- Use a damp cloth to keep the casing clean.
- Periodically check all cable and tube connections.
- Keep filters clean to ensure proper solder suction and replace them when necessary.

Suction filter
Ref. 0821830

Cotton filters
Ref. 0781046

O Ring
Ref. 0007717

Filter cover
Ref. 0004710

Removing the pneumatic tubing

- Push the release ring to remove the pneumatic tubing.

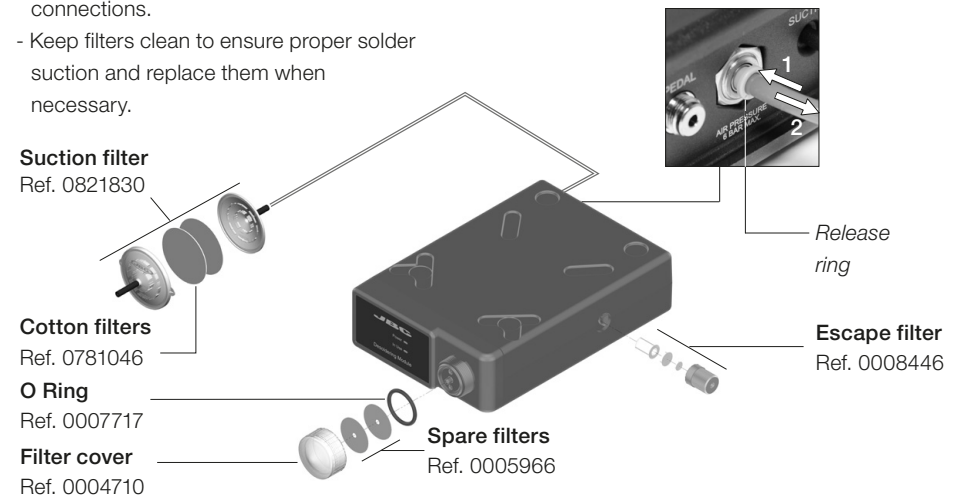

Important: Do not use sharp pointed objects to open the suction filter.

Operation

The JBC Exclusive Heating System

Our revolutionary technology is able to recover tip temperature extremely quickly. It means the user can work at a lower temperature and improve the quality of soldering. The tip temperature is further reduced thanks to the Sleep and Hibernation modes which increase the tip life by 5.

1. Work



When the tool is lifted from the stand the tip will heat up to the selected temperature.

2. Sleep



When the tool is in the stand, the temperature falls to the preset Sleep temperature.

3. Hibernation



After longer periods of inactivity, the power is cut off and the tool cools down to room temperature.

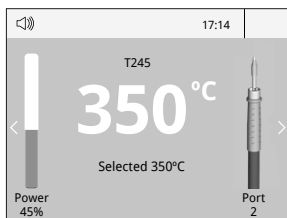

Tools Menu:

- Set temperature limits
- Select temperature levels



Tools Menu:

- Set Sleep temperature
- Set Sleep delay (from 0 to 9 min or no Sleep)

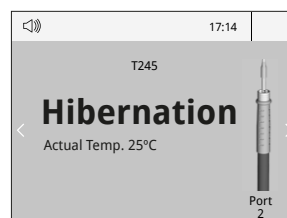

Tools Menu:

- Set Hibernation delay (from 0 to 60 min or no hibernation)

Work Screen

The DDE offers an **intuitive user interface** which provides **quick access** to station parameters.

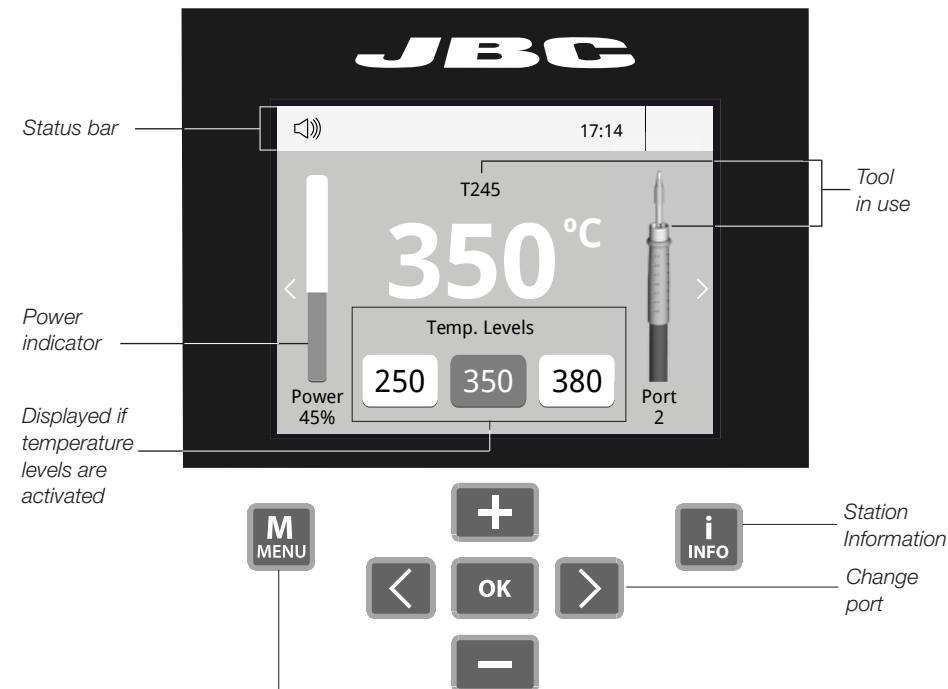

Menu Options

Press INFO for each parameter description.

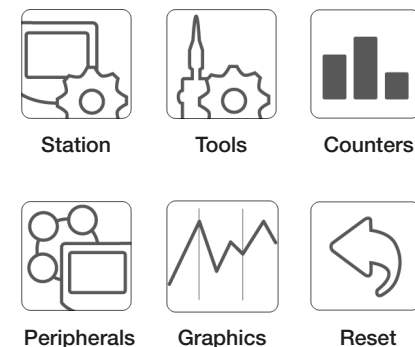

System notifications (Status Bar)

- USB flash drive is connected.
- Station is controlled by a PC.
- Station is controlled by a robot.
- Station software update. Press INFO to start the process.
- Warning. Press INFO for failure description.
- Error. Press INFO for failure description, the type of error and how to proceed.

Process analysis



Graphics

By pressing **Graphics** in the main MENU, temperature and power figures in real time are displayed for each port. This helps you decide which tip to use to obtain the best quality solder joints.

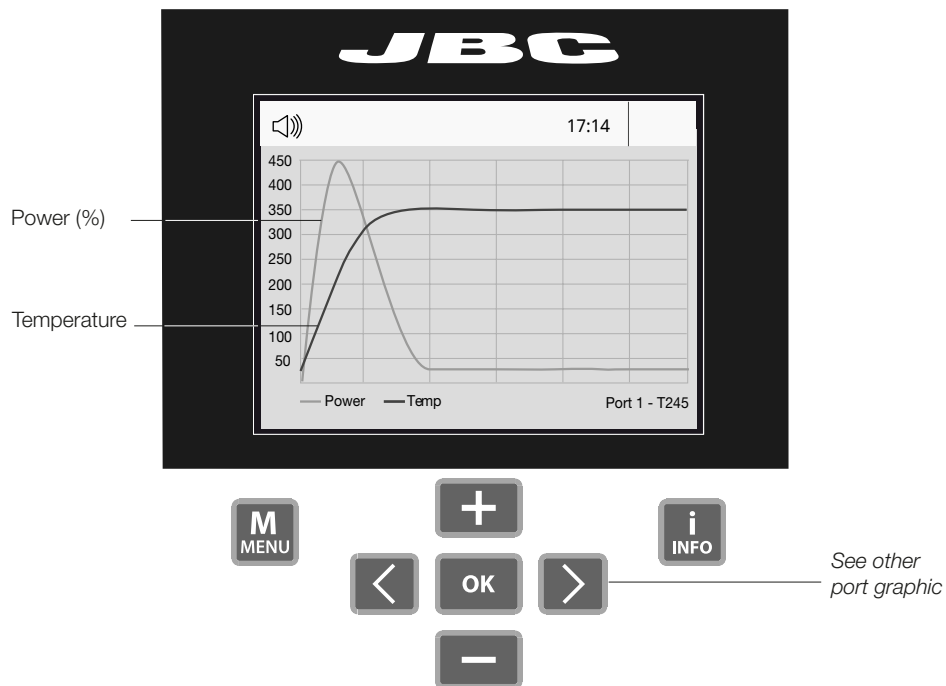

Export graphics

Insert a USB flash drive into the USB-A connector to save your soldering process in csv format.



Soldering Net

Remotely manage and monitor as many stations as your PC can handle.

1. Download the **JBC Manager software** and the user manual from www.jbctools.com/manager.html
2. Connect the stations via USB-B connector and the PC will automatically detect them.
3. The notification  will be displayed on the station.

Functions:

- Set all the station parameters from your PC.
- Organize groups of stations and set all their parameters at the same time.
- Store specific configurations for later uses.
- Analyze the soldering graphics of the stations on your PC and export them.

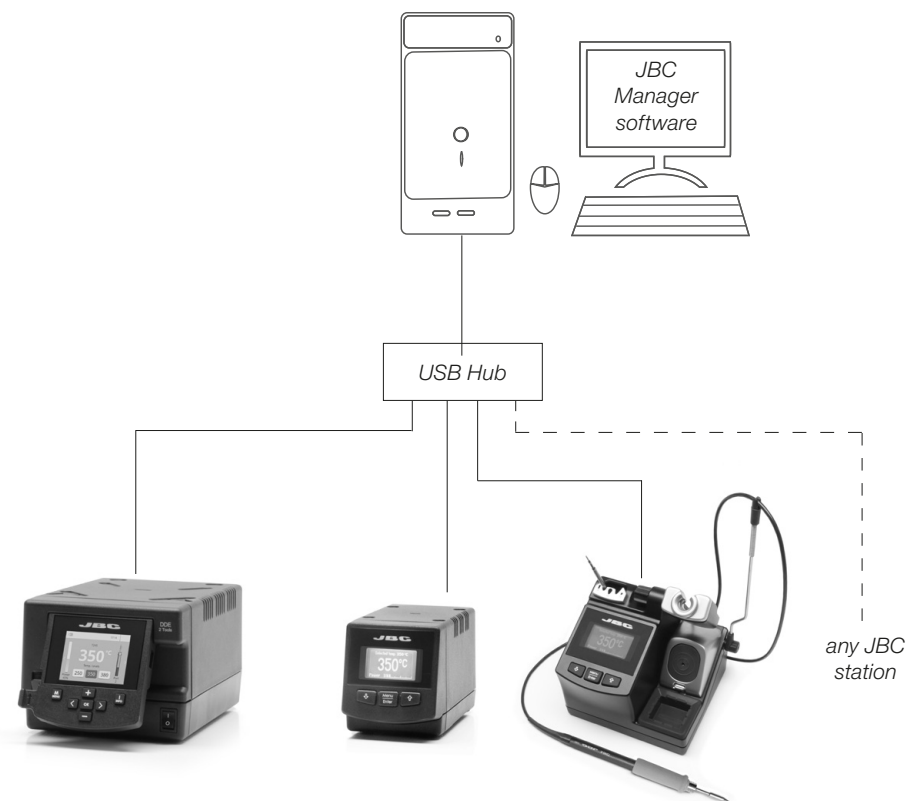

Working with Robots

Manage and monitor the station using a Robotic system.

1. Connect the tool to the station port by means of the CHB-A Converter.
2. Connect your Robot system to the Robot connector (RJ12) of the station.
DB9-RJ12 Adapter available only if necessary (Ref: 0013772).
3. Enable the Robot option in the station settings and the notification will be displayed: 
4. Set your Robot's commands according to the Robot Communication Protocol, available on the website www.jbctools.com/jbcsoftware-menu-115.html.

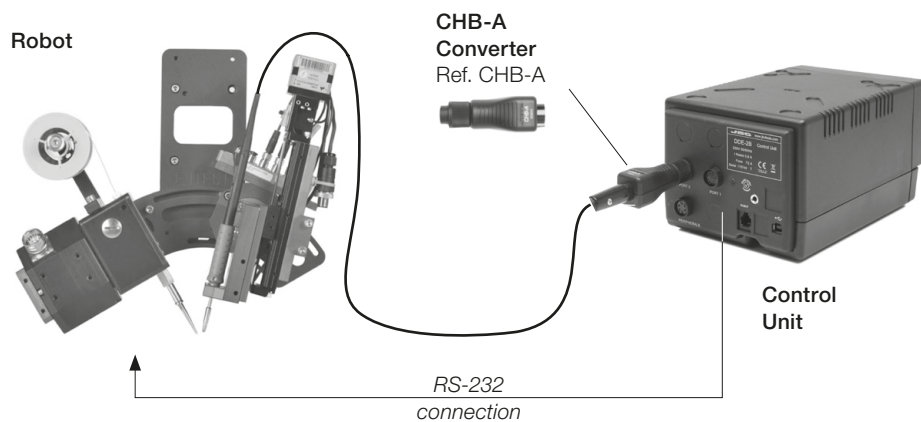

Update the station software

1. Download the JBC Update File from www.jbctools.com/software.html and save it on a USB flash drive. Preferably one with no other files.

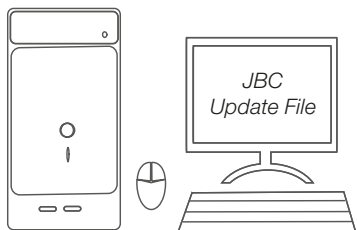

2. Insert the USB flash drive to the station. The icon  is displayed while updating.



Maintenance

Before carrying out maintenance or storage, always allow the equipment to cool.

- Clean the station screen with a glass cleaner or a damp cloth.
- Use a damp cloth to clean the casing and the tool. Alcohol can only be used to clean the metal parts.
- Periodically check that the metal parts of the tool and stand are clean so that the station can detect the tool status.
- Maintain tip surface clean and tinned prior to storage in order to avoid tip oxidation. Rusty and dirty surfaces reduce heat transfer to the solder joint.
- Periodically check all cables and tubes.
- Replace a blown fuse as follows:



Clean periodically

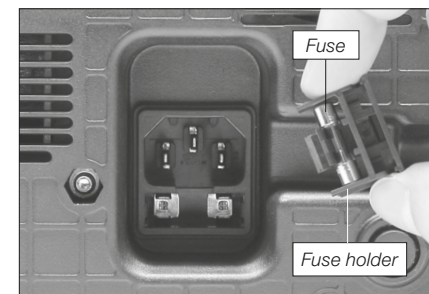
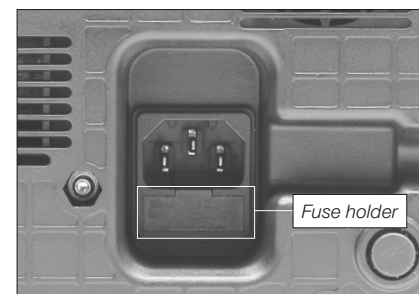
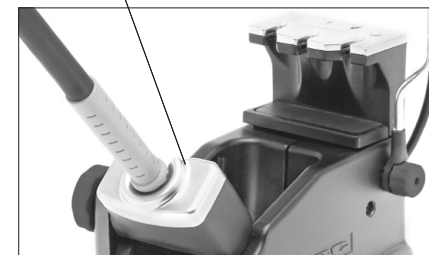

1. Pull off the fuse holder and remove the fuse. If necessary use a tool to lever it off.

2. Press the new fuse into the fuse holder and replace it in the station.

- Replace any defective or damaged pieces. Use original JBC spare parts only.
- Repairs should only be performed by a JBC authorized technical service.

Safety



It is imperative to follow safety guidelines to prevent electric shock, injury, fire or explosion.

- Do not use the units for any purpose other than soldering or rework. Incorrect use may cause fire.
- The power cord must be plugged into approved bases. Be sure that it is properly grounded before use. When unplugging it, hold the plug, not the wire.
- Do not work on electrically live parts.
- The tool should be placed in the stand when not in use in order to activate the sleep mode. The soldering tip, the metal part of the tool and the stand may still be hot even when the station is turned off. Handle with care, including when adjusting the stand position.
- Do not leave the appliance unattended when it is on.
- Do not cover the ventilation grills. Heat can cause inflammable products to ignite.
- Use a "non residue" classified flux and avoid contact with skin or eyes to prevent irritation.
- Be careful with the fumes produced when soldering.
- Keep your workplace clean and tidy. Wear appropriate protective glasses and gloves when working to avoid personal harm.
- Utmost care must be taken with liquid tin waste which can cause burns.
- This appliance can be used by children over the age of eight and also persons with reduced physical, sensory or mental capabilities or lack of experience provided that they have been given adequate supervision or instruction concerning use of the appliance and understand the hazards involved. Children must not play with the appliance.
- Maintenance must not be carried out by children unless supervised.

Specifications

Complete Rework station with Pneumatic Pump RMVE-1C / RMVE-2C / RMVE-9C

- Total weight: 15.8 kg (35 lb)
- Ambient Operating Temperature: 10 to 40°C (50-104°F)

JTE-1D 120V 50/60Hz. Input fuse 8A

JTE-2D 230V 50/60Hz. Input fuse 4A

JTE-9D 100V 50/60Hz. Input fuse 8A

- Weight: 5.7 kg (12.6 lb)
- Dimensions: 148 x 184 x 140
- Nominal Power: 700W
- Temperature range: Room temperature / 150°C to 450°C (300°F to 840°F)
Cool mode: T Off. Used to blow air at room temperature.
- Air flow regulation: 10-50 SLPM
- Vacuum: 30% / 228 mmHg / 9 inHg
- USB interface station-PC
- P-005 Pedal connection

DDE-1B 120V 50/60Hz. Input fuse: 4A. Output: 23.5V

DDE-2B 230V 50/60Hz. Input fuse: 2A. Output: 23.5V

DDE-9B 100V 50/60Hz. Input fuse: 5A. Output: 23.5V

- Weight: 4.3 Kg (9.4 lb)
- Dimensions: 148 x 120 x 232 mm
- Output Peak Power: 150W per tool
- Temperature Range: 90-450°C (190-840 °F)
- Idle Temp. Stability (still air): ±1.5 °C (±3 °F)
- Tip to ground resistance: <2 ohms
- Tip to ground voltage: <2mV RMS
- USB-A / USB-B / Peripherals connectors
- RJ12 connector for Robot

MVE-A

- Weight: 1 Kg (2.2 lb)
- Dimensions: 145 x 55 x 225 mm
- Air Pressure supply range: 4-6 Bar
- Vacuum at 6 Bar: 90% / 680 mmHg / 26.8 inHg
- Flow rate: 15 SLPM
- P-005 Pedal connection

Complies with CE standards
ESD protected housing "skin effect"

Índice

Composición	38
JT Estación de Aire Caliente	
Características	42
Soporte ajustable	43
Extractor de boquillas	44
Protectores y extractores	45
T260 Lápiz posicionador	46
Funcionamiento y Control del proceso.....	47
JT-TA Reemplazar elemento calefactor.....	50
JT-TA Cambiar el conjunto calefactor.....	51
DDE Unidad de Control y MVE módulo	
Características	52
Soportes	54
Limpiador de Puntas	55
T245 Cambiar Cartuchos	56
DR560 Cambiar Puntas	57
DR560 Cambiar elemento calefactor	58
DR560 Limpiar depósito de estaño	59
DR560 Mantenimiento de las puntas	60
Desoldar con la DDE y el MVE	60
MVE Puesta en marcha	61
MVE Cambiar los filtros	61
Cambiar el tubo del módulo	61
Funcionamiento	62
Pantalla de trabajo	63
Análisis del proceso	64
Red de Soldadura	65
Trabajar con Robots	66
Actualizar el <i>Sotware</i> de la estación	66
Mantenimiento	67
Seguridad	68
Especificaciones	69
Despiece	70

Composición

Los siguientes artículos deberían estar incluidos:

JTE Control Unit

Unidad de Control JTE ... 1 ud
Ref. JTE-1D (120V)
JTE-2D (230V)
JTE-9D (100V)



DDE Control Unit

Unidad de Control DDE 1 ud
Ref. DDE-1B (120V)
DDE-2B (230V)
DDE-9B (100V)



Pneumatic Desoldering Module

Módulo desoldador neumático 1 unidad
Ref. MVE-A



Stand

Soporte 1 unidad
Ref. JT-SD



Stand

Soporte 1 unidad
Ref. AD-SD



Stand

Soporte 1 unidad
Ref. DR-SD



Heater hose set

Conjunto calefactor 1 ud
Ref. JT-T1A (100V / 120V)
JT-T2A (230V)



General Purpose Handle

Mango para aplicaciones generales 1 unidad
Ref. T245-A



Desoldering Iron

Desoldador 1 unidad
Ref. DR560-A



Extractor stand*

Soporte de extractores 1ud
Ref. 0008752



Tip Cleaner

Limpiador de puntas 1 ud
Ref. CL9885



Cartridges

Cartuchos 2 units
Ref. C245903 (x1)
C245906 (x1)



Conjunto de accesorios JT Ref. 0012332

Extractors*

Extractores
Ref. E2184
E2064
E2052

Protectors*

Protectores
Ref. P2220
P2230
P2235
P4000
P4010

Suction Cups*

Ventosas
Ref. 0930110
Ø 10 - 0934050 (x3)
Ø 4.7 - 0934070 (x1)



Tripod* · Tripode

Ref. T2050 (Ø 39mm)
T2250 (Ø 85mm)



Suction Tube*

Tubo de succión
Ref. 0932330



Nozzles

Boquillas
Ref. JN2015 (x1)
JN2012 (x1)
JN2020 (x1)



Sponge

Esponja 1 unidad
Ref. S0354



Metal Brush







Cepillo metálico 1 unidad
Ref. CL6217

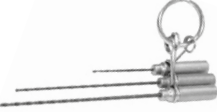

* Estos accesorios no se suministran con las estaciones JT-2QC / JT-1QC / JT-9QC.

Accesorios del DR560

Ref. 0010211

Tip cleaning set	Long Tip Cleaning set	
<i>Juego de limpieza de puntas 1 unidad</i> Ref. 0965970	<i>Juego de limpieza de puntas largo 1 ud</i> Ref. 0965760	
		
Tips	Tin deposit	Spanner
<i>Puntas 3 unidades</i> Ref. C560005 (x1) C560013 (x1) C560004 (x1)	<i>Depósito de estaño 1 ud</i> Ref. 0812620	<i>Llave 1 unidad</i> Ref. 0780550
		
Filter Box	Internal gasket	Metal tin deposit
<i>Caja de filtros 1 unidad</i> Ref. 0780840 <i>Contiene 10 filtros</i>	<i>Casquillo junta interior 2 unidades</i> Ref. 0812360	<i>Depósito de metal para estaño 1 unidad</i> Ref. 0812630
		

Cotton Filter

Filtros de algodón ... 1 unidad
Ref. 0781046
Contiene 10 filtros



Filter Box

Caja de filtros 1 unidad
Ref. 0005966
Contiene 50 filtros



Suction Filter

Filtro de aspiración ... 1 unidad
Ref. 0821830



Pick & Place

Lápiz posicionador ... 1 unidad
Ref. T260-A



Bent Needles Set

Conjunto de agujas dobladas 1 unidad
Ref. 0861660



Straight Needles Set

Conjunto de agujas rectas 1 unidad
Ref. 0901546



Suction Cup Set

Conjunto de ventosas 1 ud
Ref. 0940163



Cleaning stick

Bastoncillo de limpieza ... 1 unidad
Ref. 0786640



Stand Cable

Cable del soporte 2 uds
Ref. 0011283



Module Cable

Cable del módulo 1 unidad
Ref. 0014874



Union Flanges

Bridas de unión 1 unidad
Ref. 0011356
Contiene 2 bridas



Escape Filter

Filtro de escape 1 unidad
Ref. 0008446



Cables de red

Para DDE 1 unidad
Ref. 0013671 (100/120V)
0010569 (230V)



Para JTE 1 unidad
Ref. 0009417 (100V/120V)
0009401 (230V)



Manual 1 unidad
Ref. 0017358

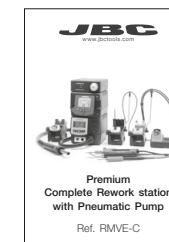

JT Características

USB-B connector

Actualice el software de la estación en www.jbctools.com

Activación de la bomba de succión



Elemento calefactor

Heater Hose set
Conjunto calefactor
Ref. JT-T1A (100V - 120V)
JT-T2A (230V)

Interruptor para aire caliente (ON / OFF)

Suction Tube

Tubo de succión
Ref. 0932330
Para trípodes y extractores

Otra herramienta conectable:

Precision Heater hose set

Conjunto calefactor de precisión
Ref: TE-TB

Soporte
Ref. JT-SD

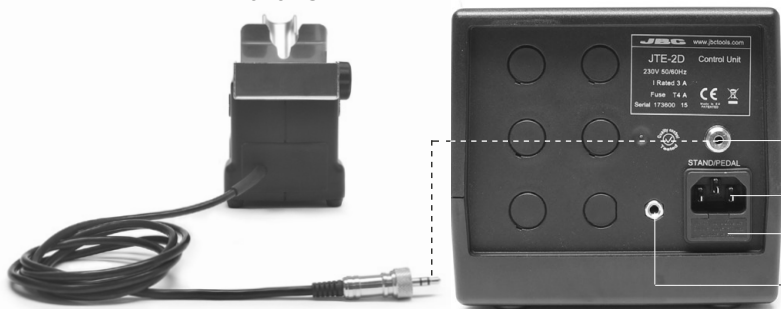

Al Pedal
Ref. P-005
Con el pedal pulsado se emite aire caliente.

Entrada de red
Fusible
Conexión equipotencial

Soporte ajustable

El elemento ajustable del soporte se adapta a su posición de trabajo.



Modos de operación

1. Desde el menú principal, seleccione el modo de activación de la herramienta en función de la tarea a desarrollar.

Soporte + Autostart OFF



Pulse el interruptor para emitir aire caliente.

Soporte + Autostart ON

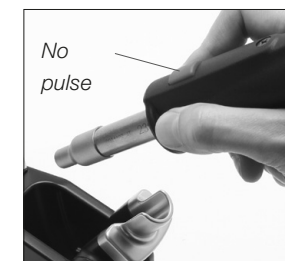

La herramienta se activa automáticamente cuando se levanta del soporte.

Pedal*

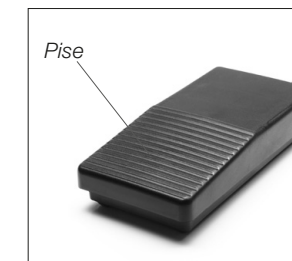

Use el pedal para el control del calefactor.
*El pedal **P-005** no se incluye en esta estación.
Consulte nuestra web.

2. La herramienta deja de emitir aire caliente cuando se deja en el soporte.



Extractor de boquillas

Changing nozzles quickly and safely.

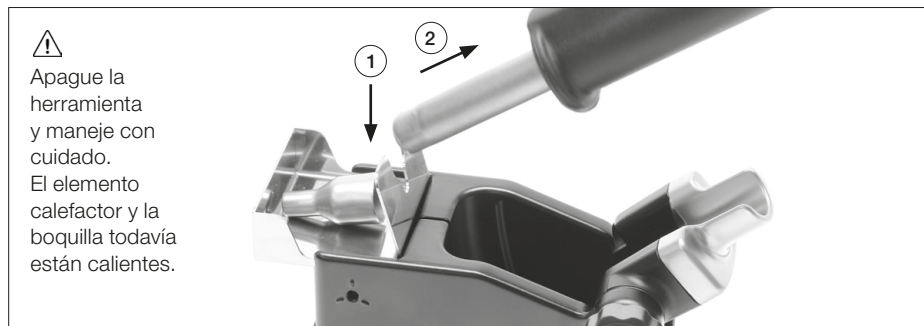

⚠
Apague la herramienta y maneje con cuidado. El elemento calefactor y la boquilla todavía están calientes.

Boquillas compatibles

El JT-TA funciona con las boquillas JT. Encuentre el modelo que mejor se ajuste a sus necesidades de trabajo en www.jbctools.com

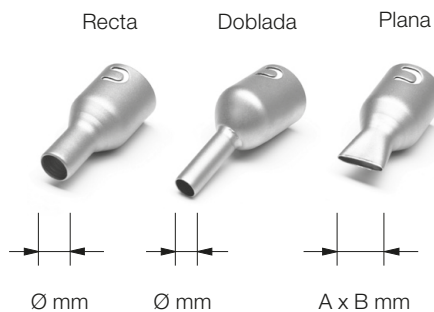

Ref.	Forma	Medida
JN2020	Recta	Ø 8mm
JN8417	Recta	Ø 10mm
JN2015	Doblada	Ø 4mm
JN2012	Doblada	Ø 6mm
JN6633	Doblada	Ø 8mm
JN7637	Plana	10 x 2mm
JN7638	Plana	20 x 2mm
JN7639	Plana	30 x 2mm

Para una mejor sujeción de la boquilla:

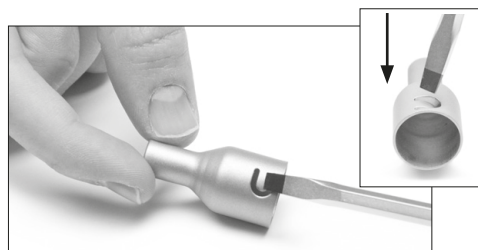

1. Empuje la lengüeta hacia dentro con la ayuda de un destornillador o unos alicates planos.

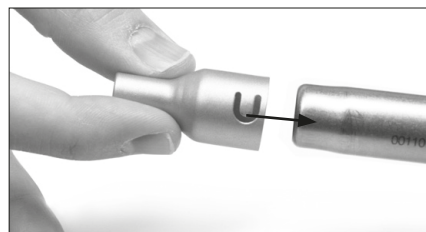

2. Inserte la boquilla en el conjunto calefactor.

Protectores y extractores

Para componentes pequeños (fig. 1 y 2)
Recomendamos usar protector + trípode

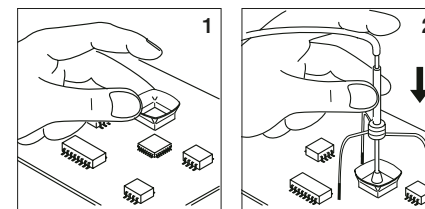

Protectores

* Ref.	AxB (mm)	* Ref.	AxB (mm)
P3353	4,3 x 3	48 P2230	15 x 15
P3786	5,2 x 5,2	60 P4010	17 x 17
P3352	5,2 x 7,5	P4005	18 x 29
P3355	5,2 x 9,5	P4030	18,5 x 18,5
P3356	6,2 x 4,2	P1068	18,5 x 24
P3785	7,2 x 7,2	P2685	28,5 x 28,5
P3784	8,2 x 8,2	P4085	31,5 x 31,5
P4035	9 x 13	P2672	33 x 46
P4040	9,5 x 19	P4002	50 x 50
P4080	9,5 x 21	P3357	52,5 x 14
32 P2220	10 x 10		
P4045	10,5 x 21		
P4090	11 x 16		
24 P2235	12 x 17		
P1249	12 x 23		
44 P4000	12,5 x 12,5		
P3354	13,2 x 13,2		
P4025	13,5 x 21,5		

* Referencia del soporte de extractores

Para componentes grandes (fig. 3 y 4)
Recomendamos usar extractores

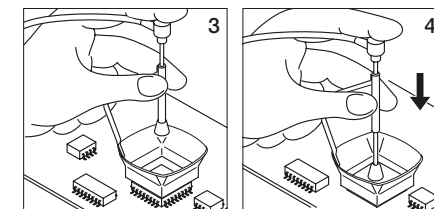

Extractores

* Ref.	AxB (mm)	* Ref.	AxB (mm)
52 E2052	20 X 20	E2124	45 X 45
64 E2064	20 X 26		
80 E2184	24 X 24		
E2068	27 X 27		
E4020	28,5 X 28,5		
E4015	31,5 X 31,5		
E2084	33 X 33		
E2100	38 X 38		

Tripodes

* Ref.	øC (mm)
T2050	39
T2250	85

Extractor manual

* Ref.	øD (mm)
E2190	7

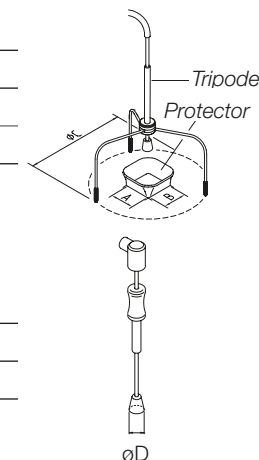

T260 Lápiz posicionador

Esta herramienta permite colocar y retirar SMDs fácilmente gracias al sistema de succión de la unidad.

Pick & Place
Lápiz posicionador
Ref. T260-A

Apriete para iniciar o detener la succión

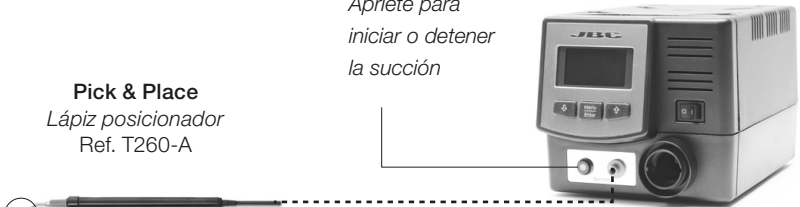

Elija la **ventosa** que mejor se adapte al componente (Temp. máxima de trabajo: 250°C / 482°F):

Inserte la aguja en la ventosa apropiada para una succión correcta.

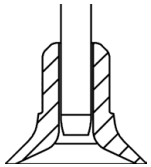

Evite que la aguja sobresalga de la parte inferior de la ventosa.

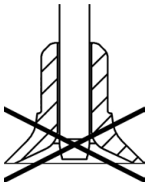

Funcionamiento

1. Succionar

Una vez activado el botón de succión, cubra el agujero del lápiz con el dedo hasta y recoja el componente.

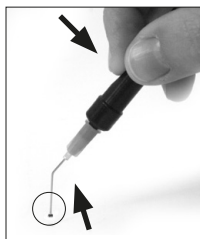

2. Soltar

Levante el dedo del agujero para soltar el componente en el sitio adecuado.

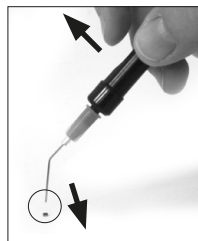

Funcionamiento de la JT

1. Colocar

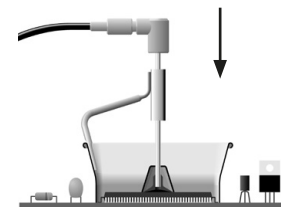

Posicione la ventosa y apriete el botón de succión.

2. Calentar

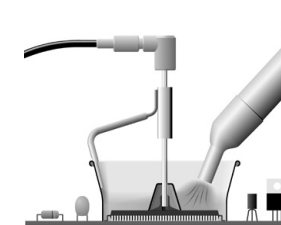

Proyecte aire caliente con el conjunto calefactor.

3. Soltar

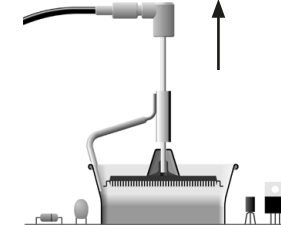

El componente se levantará automáticamente cuando el estaño se derrita.

Control del proceso

Modo manual

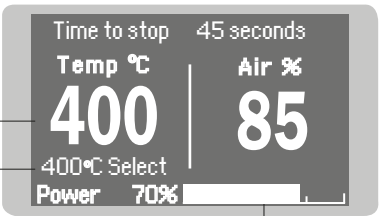

Time to stop 45 seconds

Temp °C 400

Air % 85

400°C Select

Power 70%

Temperatura actual

Temperatura seleccionada

% potencia

↓ Menu/Enter ↑

Confirme la selección
Para acceder al Menú (apriete 2 segundos)

Puede intercambiar los modos (manual / programa) apretando las teclas "aumentar" o "disminuir" simultáneamente durante 2 segundos (sólo si el modo programa está activo).

Modo programa

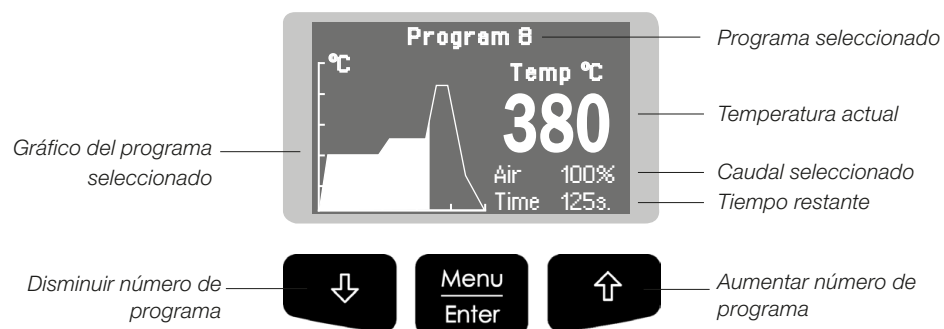

Opciones de Programa

Edit Program

Esta opción le permite crear o editar un programa. Seleccione un número de programa a editar y modifique los puntos en función de sus necesidades de trabajo. Cada programa se compone de 9 puntos y cada punto consiste en 3 parámetros:

1. **Tiempo** (segundos)
2. **Temperatura** (°C / °F)
3. **Caudal de Aire** (%)

Puede borrar el último punto del programa seleccionando "-----" en el parámetro Tiempo.

Tenga en cuenta que el rango de temperatura permitido por la estación es 150- 450°C, por lo que no es posible crear rampas de temperatura entre la temperatura ambiente y los 150°C.

La estación puede almacenar hasta **25 programas** de temperatura. Los primeros 3 programas que muestra la estación han sido editados por JBC a modo de ejemplo.

Copy Program

Esta opción le permite copiar un programa. Seleccione la opción "program source" e indique el programa que quiere copiar. A continuación seleccione "program destination" e indique el programa donde será copiado. En el momento de salir (Exit) podrá salvar los cambios.

Delete Program

Esta opción le permite borrar un programa previamente seleccionado.

Pantallas de Menú

PIN original: 0105

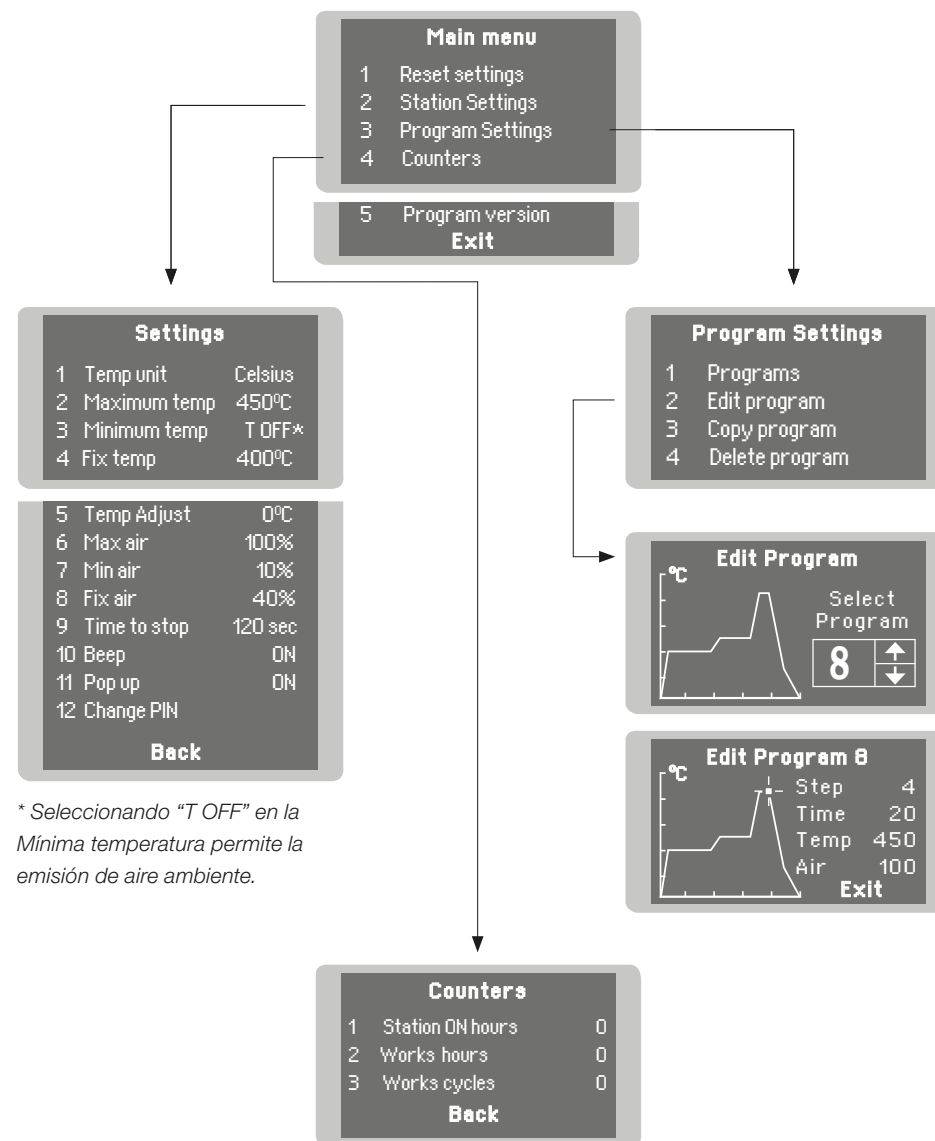

JT-TA Reemplazar el elemento calefactor

Asegúrese que el elemento calefactor está frío y la unidad de control desconectada de la red.

1. Afloje el tornillo.
2. Tire del elemento calefactor y sáquelo del mango.
3. Conecte el nuevo elemento calefactor hasta que encaje lo más adentro posible.
4. Atornille de nuevo.

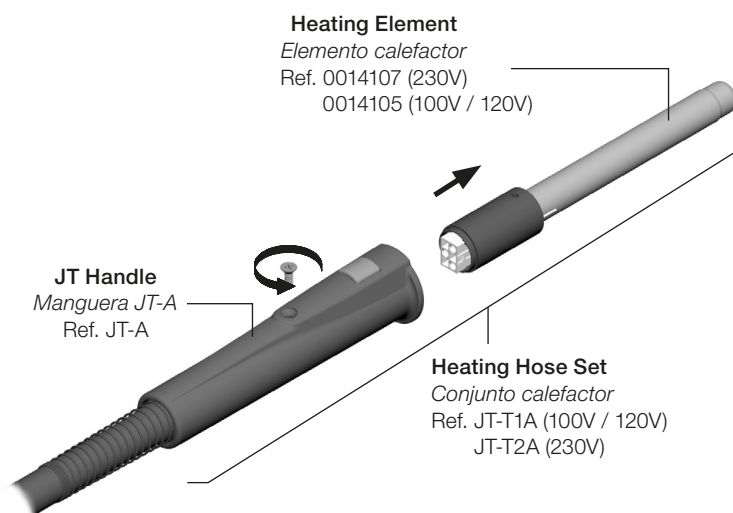

JT-TA Cambiar el conjunto calefactor

1. Apague la herramienta.
2. Desenrosque la tuerca de conexión con la ayuda de una llave inglesa.
3. Encaje el extremo del nuevo conjunto calefactor en la unidad de control.
4. Siga los mismos pasos al revés.



Características DDE y MVE

Trabaje simultáneamente con 2 herramientas y enlace cada puerto con 1 módulo + 1 pedal (Peripherals).

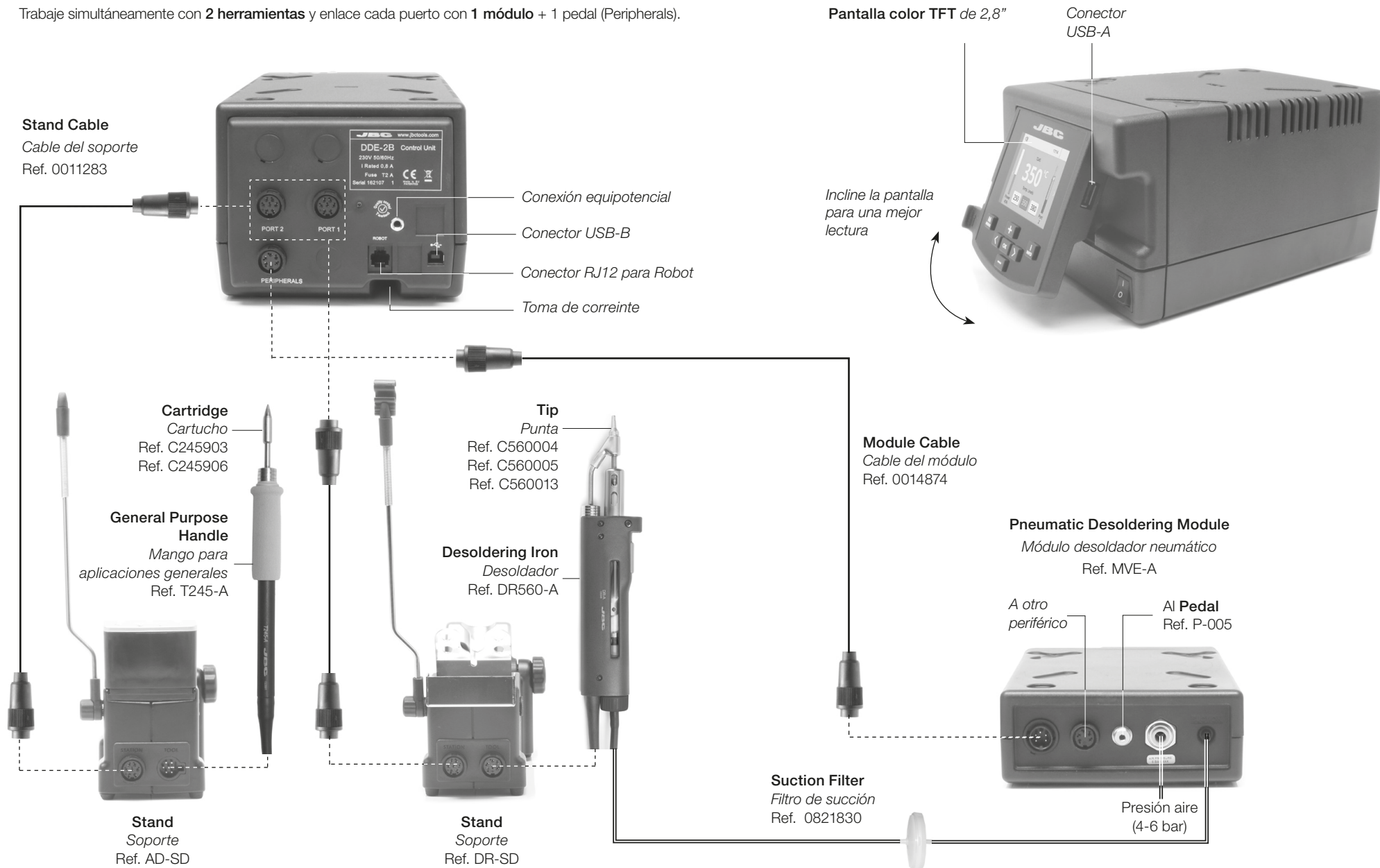

Soportes ajustables

Recogecable
Mantiene el área de trabajo ordenada sin cable

Cambio rápido de cartuchos
Cambie cartuchos sin interrumpir su trabajo

Cambio rápido de puntas
El sistema de sujeción de puntas facilita el cambio.

Stand Soporte
Ref. AD-SD

Stand Soporte
Ref. DR-SD

Soporte de herramienta ajustable
Se adapta a su posición de trabajo.

Recogecable ajustable

Limpiador de Puntas

Mejore la transferencia térmica de la punta limpiándola después de cada soldadura.

Brass wool

Lana de latón
Ref. CL6210
Método de limpieza muy efectivo. Deja una fina capa de soldadura en la punta para prevenir la oxidación entre la limpieza y la rehumectación.

Sponge

España
Ref. S0354
El método de limpieza más eficaz y menos dañino. Mantenga la esponja húmeda con agua destilada, así evitará el desgaste de la punta.

Protección anti-salpicaduras

Previene las salpicaduras de partículas de soldadura.

Base antideslizante

No es necesario sujetar la base.

Limpiador

Ref. CL0236
Receptáculo resistente a la temperatura para eliminar el exceso de soldadura golpeando y limpiando.

Para esponja:



Para cepillos:



Golpeteo:

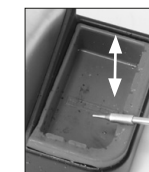

Golpe suave para retirar restos de soldadura.

Limpieza:

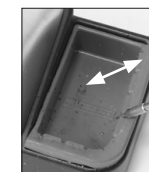

Ranuras para retirar partículas adheridas.

Mantenimiento



Se puede quitar fácilmente para su limpieza.

Opcional

Inox wool

Lana inoxidable
Ref. CL6205



Brushes

Cepillos de metal
Ref. CL6220



Tip-tinner

Reestañador de puntas
Ref. TT-A



Sand · Arena

Ref. CL6211



Cambiar cartuchos del T245

Ahorre tiempo cambiando los cartuchos de forma rápida y segura sin apagar la estación.

1. Retirar

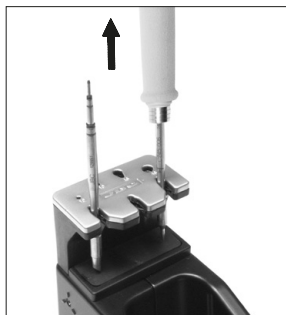

Coloque el soldador en el extractor y tire para retirar el cartucho.

2. Insertar

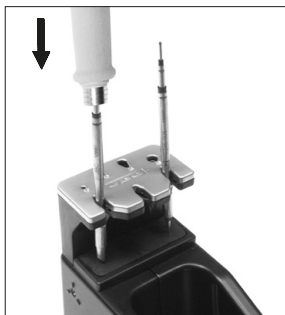

Coloque el mango soldador en la parte superior del nuevo cartucho y presione ligeramente.

3. Fijar

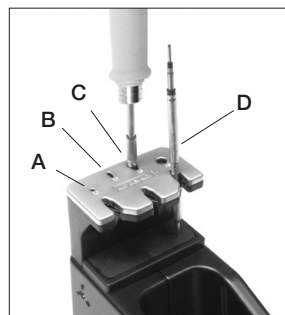

Fije el cartucho* utilizando los agujeros:

- A. Para los C210 rectos.
- B. Para los C210 curvados.
- C. Para los C245 curvados.
- D. Para los C245 rectos.

*Importante

Es necesario insertar el cartucho hasta la marca para una conexión correcta.

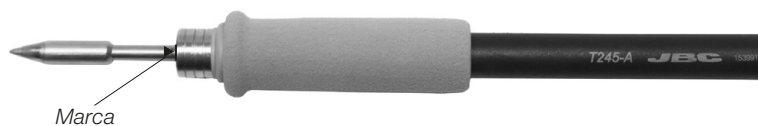

Cartuchos compatibles

El mango para soldador T245 funciona con cartuchos C245. Encuentre el modelo que mejor se adapte a sus necesidades de soldadura en www.jbctools.com

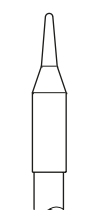

Redondo



Cinzel



Redondo curvado



Bisel

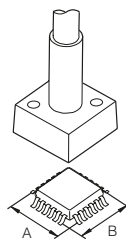

Modelos especiales

Cambiar puntas del DR560

Esta operación debe realizarse con la punta caliente (por encima de los 250°C) para que el estaño de su interior se mantenga fundido.

1. Retirar

Desenrosque la punta utilizando la llave suministrada.

2. Insertar

Coloque la punta nueva y enrósquela con la llave para asegurarse que queda hermético.



Puntas compatibles

El DR560 funciona con puntas C560.

Encuentre el modelo que mejor se adapte a sus necesidades de desoldadura en www.jbctools.com

Algunas de las puntas C560 en tamaño real (mm):

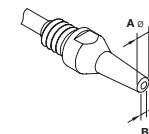

C560-001 ØA=1,4 ØB=0,6 Ømax. pin=0,4

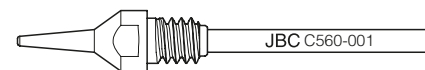

C560-002 ØA=1,8 ØB=0,8 Ømax. pin=0,6

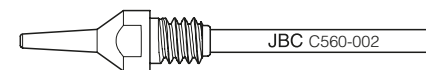

C560-014 ØA=2,5 ØB=0,8 Ømax. pin=0,6

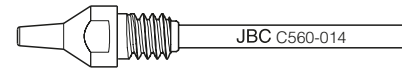

C560-003 ØA=2,7 ØB=1 Ømax. pin=0,8

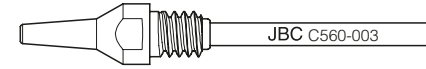

C560-004 ØA=3,2 ØB=1,3 Ømax. pin=1,1

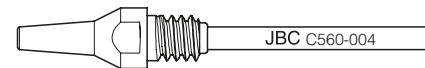

C560-009 ØA=5 ØB=1,3 Ømax. pin=1,1

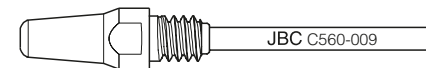

DR560 Cambiar el elemento calefactor

Para realizar esta operación apague la estación o desconecte la herramienta.

1. Desenroscar

Desenrosque la tapa del depósito.



2. Retirar

Afloje el tornillo y retire el elemento calefactor.



3. Colocar

Coloque el nuevo elemento calefactor hasta la marca* y siga los mismos pasos a la inversa.

*Importante

Para una conexión apropiada es necesario insertar el cartucho alineándolo con la marca ►.



DR560 Limpieza del depósito de estaño

1. Retirar la tapa

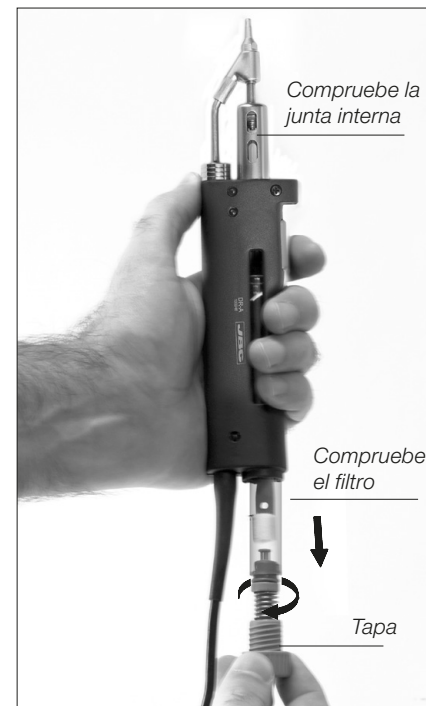

La tapa se debe retirar con el desoldador en posición vertical.

3. Insertar el depósito

El depósito se debe insertar con el espiral ya colocado entre las dos marcas.

Concluya el proceso cerrando el depósito con la tapa.

2. Limpiar

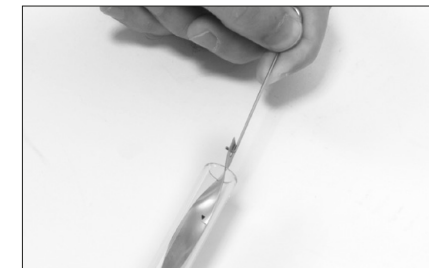

Retire el espiral para limpiar el interior del depósito con la baqueta suministrada.



El filtro y la junta interna deben supervisarse para reemplazarlos si fuera necesario, ya sea por exceso de suciedad o por algún daño.



Mantenimiento de puntas del DR560

El conducto de entrada se debe limpiar periódicamente con la baqueta más grande posible.



Importante

NO pulse el botón de la bomba de succión mientras estaña la punta, ya que los humos producidos por el flujo bloquearían rápidamente los conductos y el filtro de aire.

Proceso de desoldadura

La punta elegida debe tener un diámetro más grande que el pad para conseguir la máxima aspiración posible y el mejor rendimiento térmico.

1. Colocar

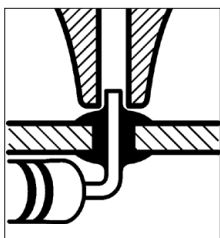

Coloque la punta en el terminal del through-hole tal y como se muestra.

2. Rotar

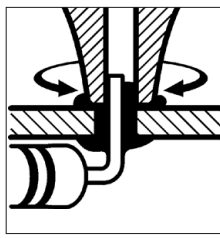

Cuando la soldadura se lique, gire la punta con suavidad para que el terminal del componente se suelte.

3. Aspirar

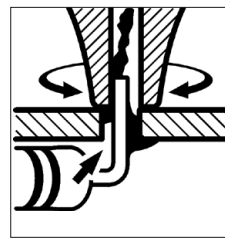

Pulse el botón de la bomba de succión hasta retirar por completo los restos de soldadura.

Tras pulsar el botón del desoldador hay un ligero retraso hasta que la bomba de succión se detiene. Esto asegura que el conducto de succión está completamente vacío.

Si se quedaran restos de soldadura en algún terminal después de desoldarlo, vuelva a soldarlo con estaño nuevo y repita el proceso de desoldadura.

Puesta en marcha de la bomba MVE



Peripherals

1. Seleccione el módulo del listado de conexiones periféricas. Recuerde que su primera conexión se indica como "a", la segunda como "b", etc. (MVE_a, MVE_b,...)

2. Pulse **Menu** o **Back** para guardar los cambios. Una vez configurado podrá modificar cambios desde el menú **Peripherals**.

Tras conectar el módulo desoldador neumático (MVE-A), entre en el menú de **Peripherals** y seleccione el puerto con el que desee enlazar el módulo.

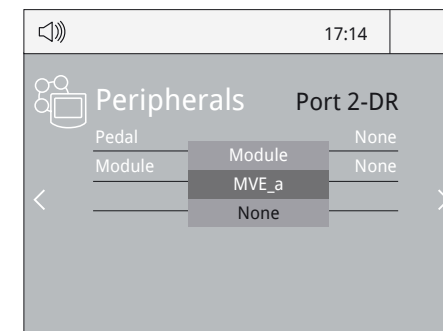

Cambiar los filtros de la bomba MVE

- Limpie la carcasa con un paño húmedo. Asegúrese que utiliza un paño suave para el frontal.
- Revise periódicamente los cables y tubos.
- Mantenga los filtros limpios para garantizar una correcta aspiración y reemplácelos si fuera necesario.

Suction filter

Filtro de aspiración
Ref. 0821830

Cotton filters

Filtros de algodón
Ref. 0781046

Anillo

Ref. 0007717

Tapa de filtros

Ref. 0004710

Cambiar el tubo del módulo

- Presione el anillo de liberación para extraer el tubo del módulo.

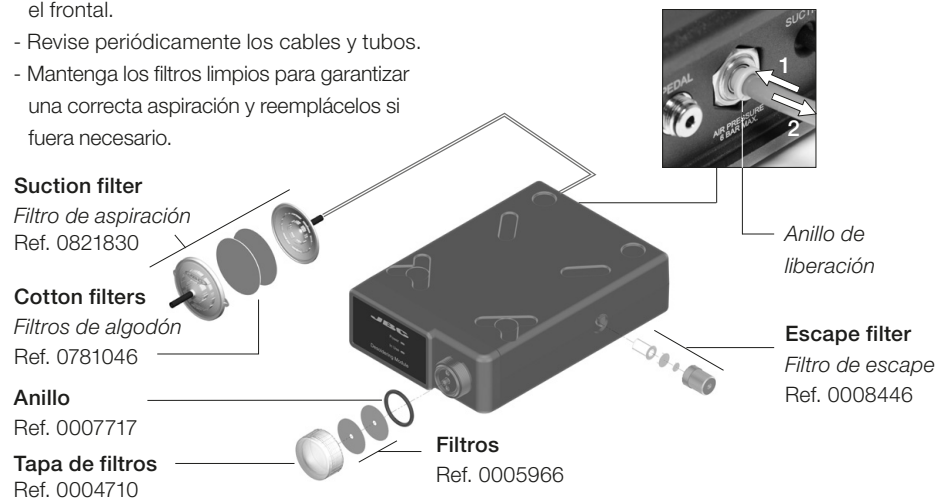

Importante: No utilice objetos punzantes para abrir el filtro de aspiración.

Funcionamiento

El exclusivo sistema calefactor de JBC

Nuestra tecnología revolucionaria es capaz de recuperar la temperatura de la punta de forma extremadamente rápida. Esto significa que el usuario puede trabajar a una temperatura más baja y mejorar la calidad de la soldadura. Esta temperatura se reduce aún más gracias a los modos de *Sleep* e *Hibernation* que incrementan hasta 5 veces la vida de las puntas.

1. Trabajo



Al levantar la herramienta del soporte, la punta se calienta hasta la temperatura seleccionada.

2. Sleep



Si la herramienta permanece en el soporte, la temperatura se reduce a la temperatura predefinida.

3. Hibernación



Tras largos períodos de inactividad (predefinido a 30min), se corta el suministro de energía y la punta se enfría hasta temperatura ambiente.

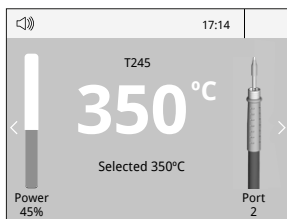

Menú *Tools*:

- Configure límites de temperatura.
- Seleccione niveles de temperatura.



Menú *Tools*:

- Configure la temperatura de *Sleep*
- Configure el tiempo de retraso de *Sleep* (de 0 a 9 min o ninguno)

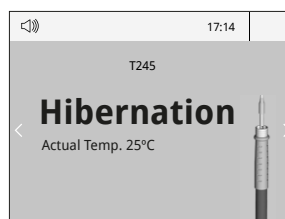

Menú *Tools*:

- Configure el retraso de Hibernación (de 0 a 60 min o ninguno)

Pantalla de trabajo

La DDE-B presenta una **interfaz de usuario intuitiva** y ofrece un **rápido acceso** a los parámetros.

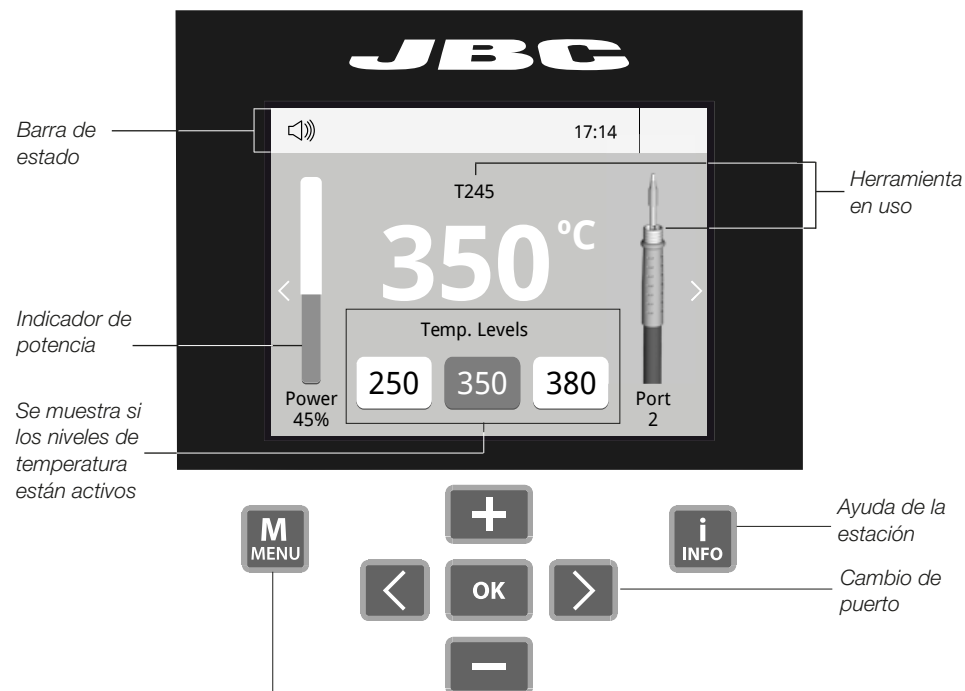

Opciones de Menú

Pulse INFO para la descripción de parámetros.

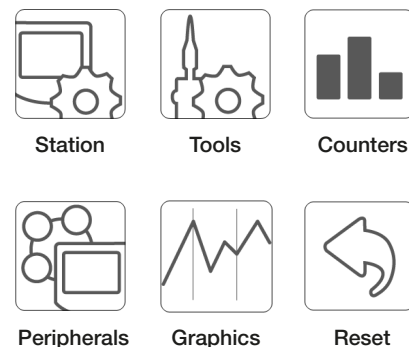

Notificaciones (Barra de estado)

- Unidad de memoria USB conectada.
- Estación controlada por un PC.
- Estación controlada por un robot.
- Actualización del software de la estación. Pulse INFO para iniciar el proceso.
- Aviso. Pulse INFO para la descripción del fallo.
- Error. Pulse INFO para la descripción del fallo, el tipo de error y cómo proceder.

Análisis del proceso



Graphics

Pulsando sobre **Graphics** en el menú principal, se muestran las respuestas de temperatura y potencia en tiempo real de cada puerto. Esto le ayudará a decidir cuál es la punta más adecuada para obtener la mejor calidad en sus soldaduras.

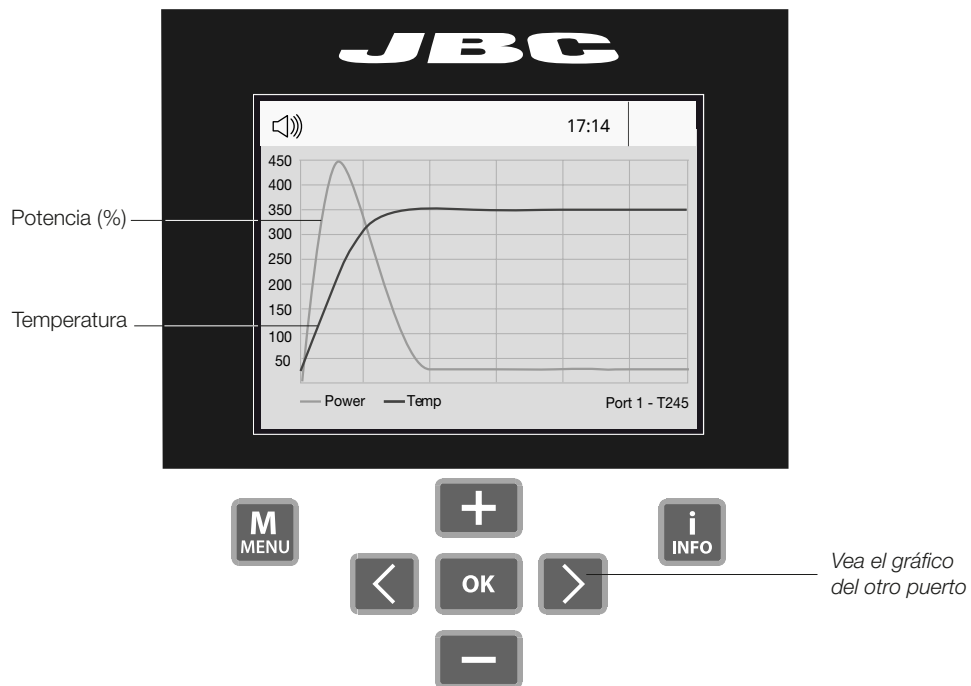

Exporte gráficos

Inserte una unidad de memoria USB para guardar su proceso de trabajo en formato csv.



Red de soldadura

Gestione y monitorice tantas estaciones como soporte su PC.

1. Descargue el software **JBC Manager** y el manual de usuario de www.jbctools.com/manager.html
2. Conecte las estaciones a través del conector USB-B y el PC las detectará automáticamente.
3. La notificación  se mostrará en la estación.

Funciones:

- Configure todos los parámetros de la estación desde su PC.
- Organice grupos de estaciones y configure todos sus parámetros al mismo tiempo.
- Guarde configuraciones específicas para usos posteriores.
- Analice gráficos del proceso de soldadura de las estaciones desde su PC y expórtelos.

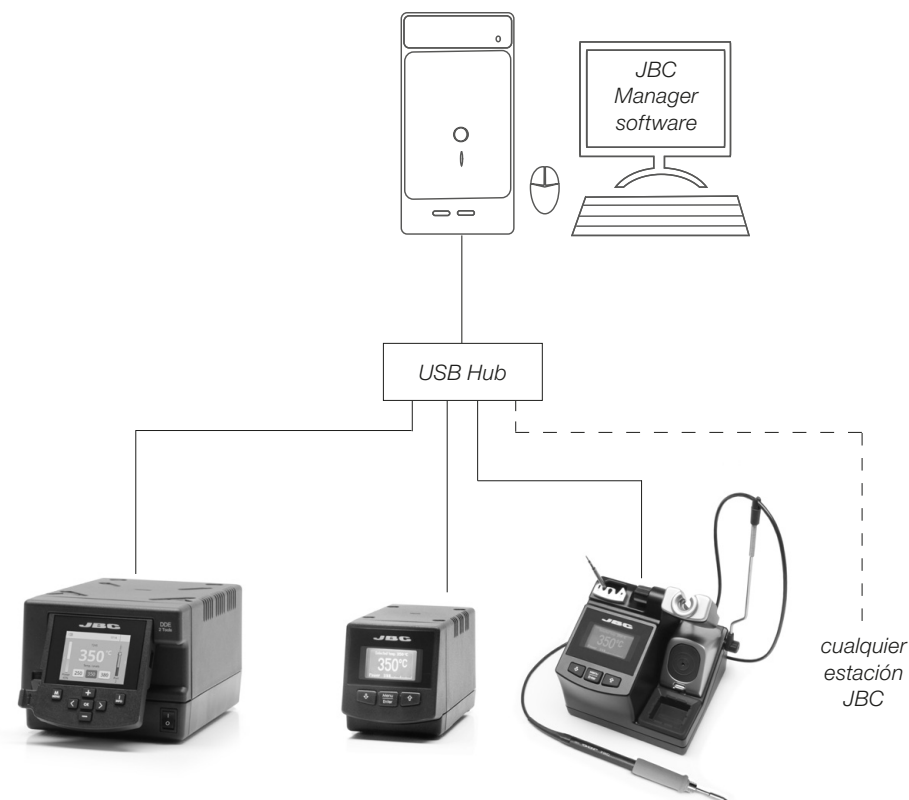

Trabajar con Robots

Gestione y monitorice la estación por medio de un sistema robotizado.

1. Conecte la herramienta a la estación utilizando el convertidor CHB-A (Ref: CHB-A).
2. Conecte su sistema robotizado al conector Robot de la estación (RJ12).
Si lo necesita, el adaptador DB9-RJ12 está disponible (Ref: 0013772).
3. Active la opción de robot en la estación y se mostrará la siguiente notificación: 
4. Configure su sistema robotizado según el Protocolo de Comunicación para Robots, que encontrará en www.jbctools.com/jbcsoftware-menu-115.html.

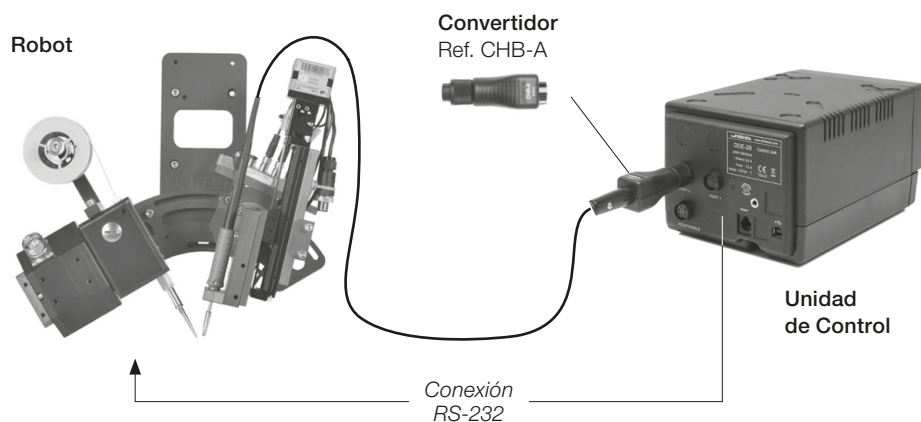

Actualice el software de la estación

1. Descargue el archivo de actualización de www.jbctools.com/software.html cuando esté disponible y guárdelo en una unidad de memoria USB (preferentemente una sin otros archivos).

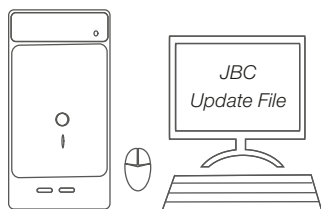

2. Inserte la unidad de memoria USB.
La notificación  se muestra mientras se actualiza el software.



Mantenimiento

Antes de realizar tareas de mantenimiento o almacenar, desconecte el equipo y déjelo enfriar.

- Use un paño húmedo para limpiar la pantalla del equipo, la carcasa y la herramienta. Puede utilizar alcohol solamente en las partes metálicas.
- Compruebe periódicamente que las partes metálicas de la herramienta y del soporte están limpias. Así la estación puede detectar el estado de la herramienta y activar los modos de *Sleep* o *Hibernation*.
- Mantenga la punta limpia y estañada la para evitar su oxidación. Las superficies sucias reducen la transferencia térmica a la soldadura.
- Revise periódicamente los tubos y cables.
- Cambie el fusible fundido de la siguiente manera:



Mantenga limpio

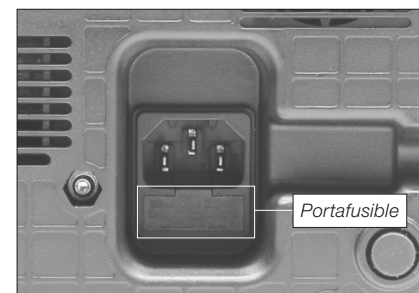

1. Tire del portafusible para retirar el fusible.
Si lo precisa, utilice una pequeña palanca.

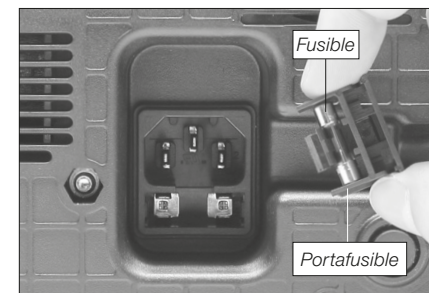

2. Sustituya el fusible y coloque de nuevo el portafusibles en su sitio.

- Cambie cualquier pieza defectuosa o dañada. Utilice solamente recambios originales de JBC.
- Cualquier reparación sólo se podrá realizar por un servicio técnico oficial JBC.

Seguridad



Es necesario cumplir estas normas de seguridad para prevenir cualquier choque eléctrico, heridas, fuego o explosiones.

- No utilice el equipo para otros fines que no sea la soldadura o reparación. El uso incorrecto puede causar fuego.
- El cable de red debe enchufarse en bases homologadas. Asegúrese de que está conectado a tierra correctamente antes de su uso. Al retirarlo, tire del conector, no del cable.
- No trabaje con tensión.
- La herramienta debe permanecer en el soporte mientras no está en uso con el fin de activar el modo de Sleep o Hibernación. El cartucho y las partes metálicas de la herramienta o del soporte pueden estar calientes incluso cuando con la estación apagada. Manipule con cuidado, incluso cuando se ajusta la posición del soporte.
- No deje el aparato desatendido cuando está en funcionamiento.
- No cubra las rejillas de ventilación. El calor puede causar que los productos inflamables se enciendan.
- Utilice flux clasificado como "non residue". Evite el contacto con la piel y ojos para que no se irriten.
- Tenga cuidado con el humo producido al trabajar.
- Mantenga su lugar de trabajo limpio y ordenado. Use gafas y guantes de protección adecuados. Así evitará cualquier daño.
- Tenga cuidado con los restos de estaño líquido. En contacto con la piel, puede causar quemaduras.
- Este aparato puede ser utilizado por personas a partir de 8 años y también por aquellas personas con movilidad reducida o capacidades físicas, sensoriales o mentales limitadas o con falta de experiencia y conocimientos siempre y cuando reciban supervisión o instrucciones relativas al uso del aparato de una manera segura y entiendan los riesgos que implica. Los niños no deben jugar con el aparato.
- Los niños no deberán realizar tareas de mantenimiento sin supervisión.

Especificaciones

Complete Rework station with Pneumatic Pump

Estación completa de reparación con bomba neumática

RMVE-1C / RMVE-2C / RMVE-9C

- Peso total: 15,8 kg (35 lb)
- Temperatura de trabajo ambiente: 10-40°C (50-104°F)

JTE-1D 120V 50/60Hz. Fusible de entrada: 8A

JTE-2D 230V 50/60Hz. Fusible de entrada: 4A

JTE-9D 100V 50/60Hz. Fusible de entrada: 8A

- Peso: 5,7 kg (12.6 lb)
- Dimensiones: 148 x 184 x 140
- Potencia nominal: 700W
- Rango de temperatura: Temp. ambiente / 150-450°C (300-840°F)
- Modo frío: T Off. Utilizado para emitir aire en temperatura ambiente.
- Regulación del caudal de aire: 10-50 SLPM
- Vacío: 30% / 228 mmHg / 9 inHg
- Conexión USB estación-PC
- Conector para pedal P-005

DDE-1B 120V 50/60Hz. Fusible de entrada: 4A. Salida: 23.5V

DDE-2B 230V 50/60Hz. Fusible de entrada: 2A. Salida: 23.5V

DDE-9B 100V 50/60Hz. Fusible de entrada: 5A. Salida: 23.5V

- Peso: 4,3 Kg (9.4 lb)
- Dimensiones: 148 x 120 x 232 mm
- Potencia máxima de pico: 150W por herramienta
- Rango de temperatura: 90-450°C (190-840 °F)
- Estabilidad de temperatura en reposo: ±1.5 °C (±3 °F)
- Resistencia punta a tierra: <2 ohms
- Tensión en punta: <2mV RMS
- Conectores USB-A / USB-B / Peripherals (periféricos)
- Conector RJ12 para Robot

MVE-A

- Peso: 1 Kg (2.2 lb)
- Dimensiones: 145 x 55 x 225 mm
- Rango de suministro de presión de aire: 4-6 Bar
- Vacío a 6 Bar: 90% / 680 mmHg / 26.8 inHg
- Caudal de aire: 15 SLPM
- Conector para pedal P-005

Cumple con las normativas CE
Seguridad ESD

Exploded View · Despiece

RMVE-1C 120V
RMVE-2C 230V
RMVE-9C 100V
COMPLETE REWORK STATION
WITH PNEUMATIC PUMP

SPARE PARTS	
DDE-1B / DDE-2B / DDE-9B:	
-REAR CIRCUIT	0016746
-ENCLOSURE	
· TOP	0011035
· BOTTOM	0014567
· FRONT+DISPLAY	0016312
· BACK	0013413
MVE-A:	
-CIRCUIT	0014059
-ENCLOSURE	
· TOP	0014860
· BOTTOM	0014861
· FRONT	0014688
· BACK	0014862
-SOLENOID VALVE	0006813

SPARE PARTS	
JTE-1D / JTE-2D / JTE-9D:	
-ENCLOSURE	
· TOP	0011035
· BOTTOM	0014882
· FRONT	0010064
· BACK	0014982
JTE-2D:	
-CIRCUIT	0016428
-SUCTION PUMP	0008722
-HOT AIR PUMP	0014271
JTE-1D / JTE-9D:	
-CIRCUIT	0016430
-SUCTION PUMP	0008723
-HOT AIR PUMP	0015570

DDE-1B 120V FUSE T-4A
DDE-2B 230V FUSE T-2A
DDE-9B 100V FUSE T-5A

JTE-1D 120V FUSE T-8A
JTE-2D 230V FUSE T-4A
JTE-9D 100V FUSE T-8A

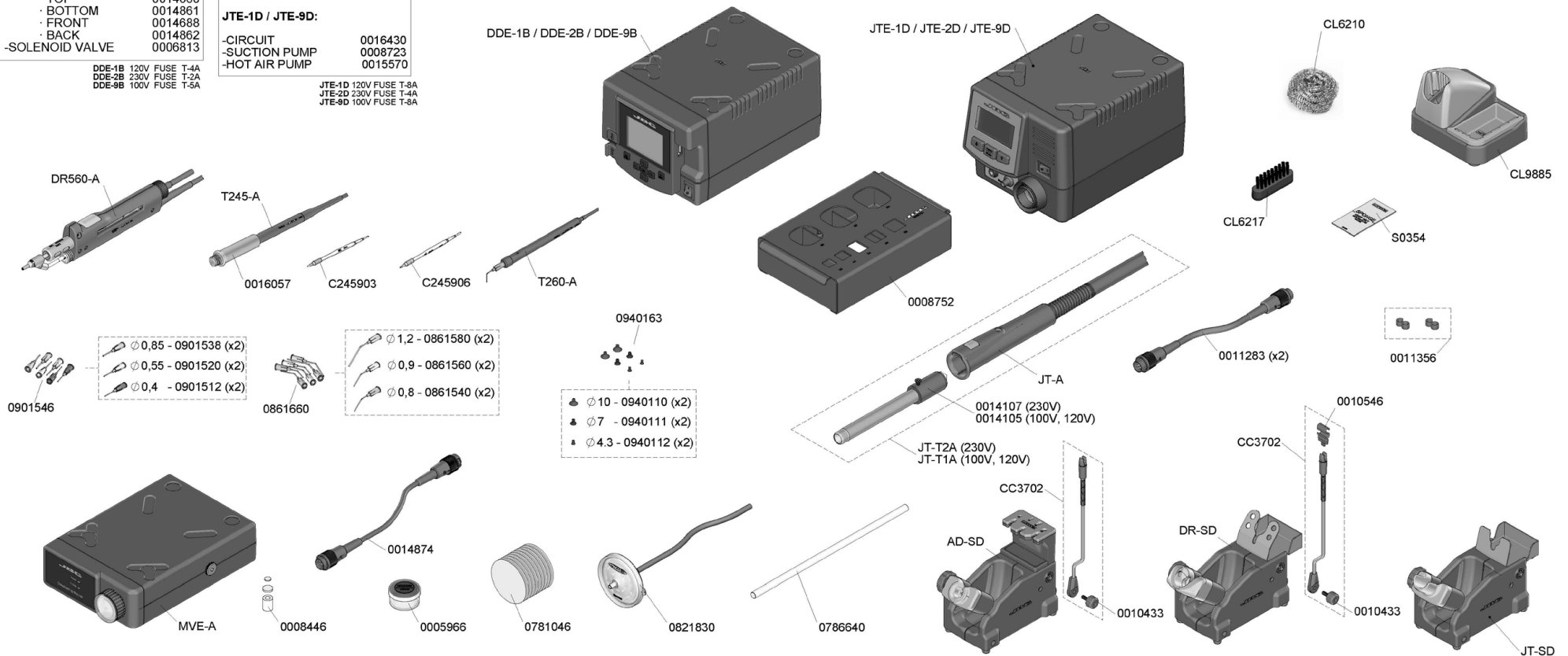
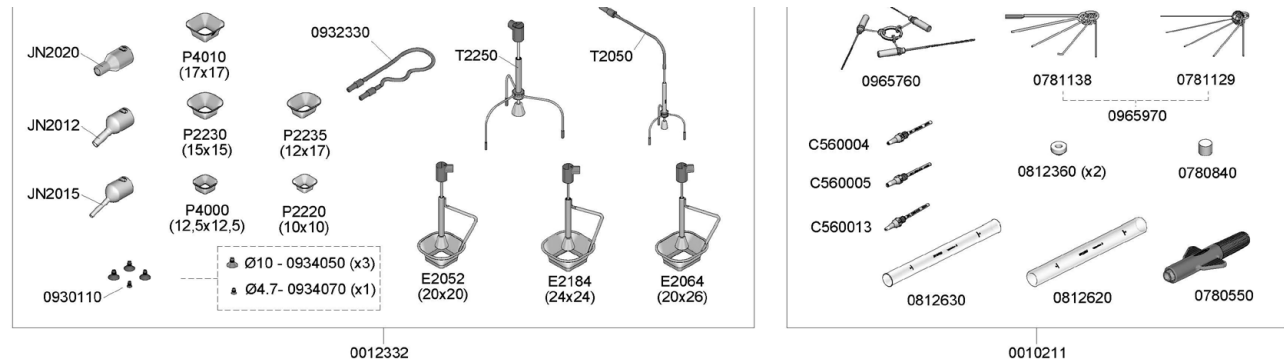



Warranty

JBC's 2 year warranty covers this equipment against all manufacturing defects, including the replacement of defective parts and labour. Warranty does not cover product wear due to use or mis-use.

In order for the warranty to be valid, equipment must be returned, postage paid, to the dealer where it was purchased.

Garantía

Esta garantía de 2 años cubre este equipo contra cualquier defecto de fabricación, incluyendo la sustitución de partes defectuosas y mano de obra. La garantía no cubre el desgaste del producto por uso o mal uso.

Para que esta garantía sea válida, el equipo debe ser devuelto, a portes pagados, al distribuidor donde se compró.



This product should not be thrown in the garbage.

In accordance with the European directive 2012/19/EU, electronic equipment at the end of their life must be collected and returned to an authorized recycling facility.

Este producto no debe desecharse en la basura.

De acuerdo a la directiva europea 2012/19/UE, los equipos electrónicos al final de su vida se deberán recoger y trasladar a una planta de reciclaje autorizada.