

JBC

www.jbctools.com

INSTRUCTION MANUAL



Precision Soldering Station

Ref. CD-SQE

Packing List

The following items are included:



CD Control Unit 1 unit
 Ref. CD-1E (120V)
 CD-2E (230V)
 CD-9E (100V)



Precision Purpose Handle 1 unit
 Ref. T210-A



Power Cord 1 unit
 Ref. 0023715 (120V)
 0023714 (230V)
 0024092 (100V)



Brass Wool 1 unit
 Ref. CL6210



Sponge 1 unit
 Ref. S0354

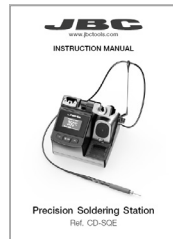

Manual 1 unit
 Ref. 0022910

Features

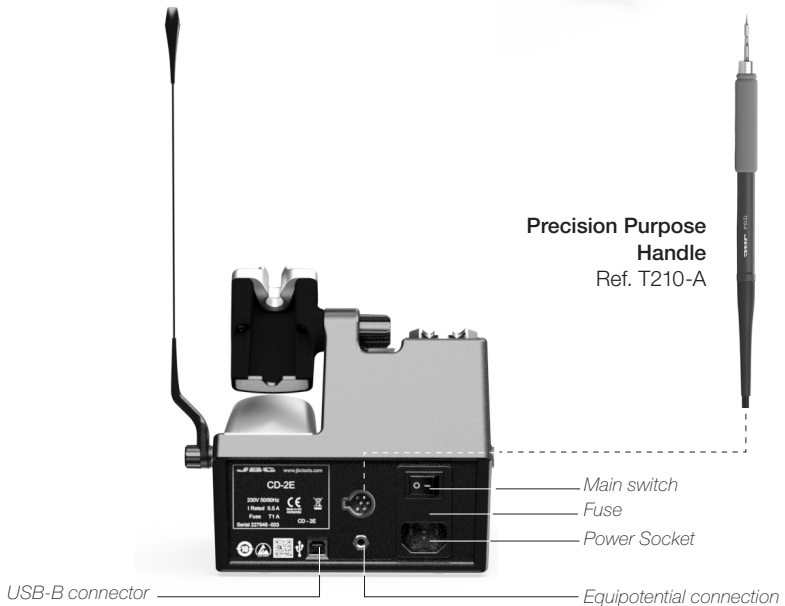

Adjustable stand

Adjust the tool stand to suit your work position.

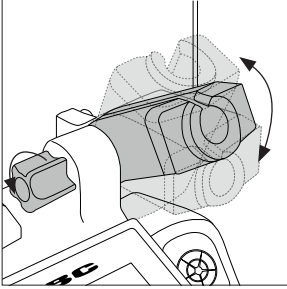

Cable collector (Ref. CC1001)

Fix the cable on the collector so that the working area is free of cable.

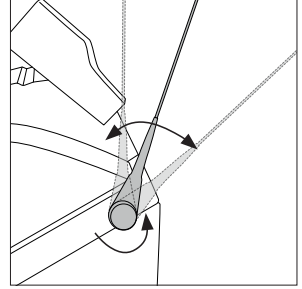
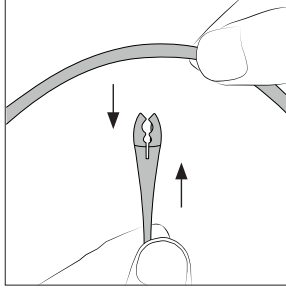

Tip Cleaner

Select the option to suit your needs and improve the thermal transfer of the tip.

Splashguard

Ref. 0017576

When using the brass wool, it prevents splashing of solder particles

Antisplash Membrane

Ref. 0017574

Prevents splashing and keeps the work area clean.

Brass Wool

Ref. CL6210

Very effective cleaning method. Leaves a small layer of solder on the tip, preventing oxidation between cleaning and rewetting.

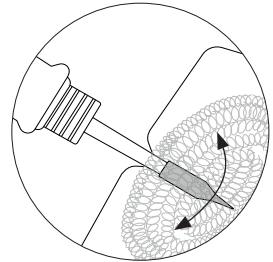
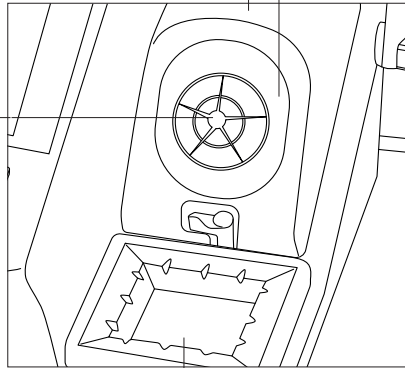
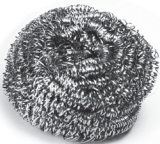

If the tip is very dirty, JBC first recommends cleaning it with the wiper to remove excess solder.

Wiper

Ref. CL0160

A temperature resistant receptacle for removing excess solder by gently tapping or wiping.

Removing the Splashguard

1. Unlock the splashguard.

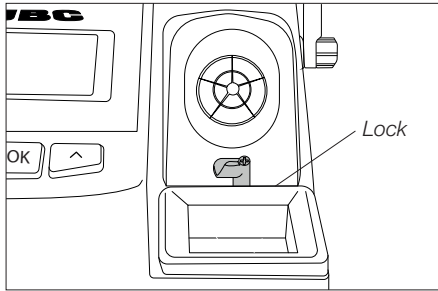

2. Lift off.

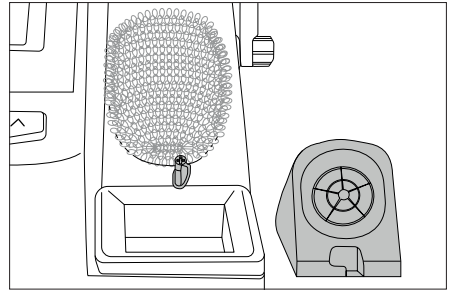

More cleaning options (not supplied):

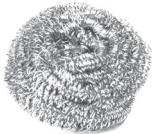

Inox Wool
Ref. CL6205
Provides a superior cleaning of the tip.



Metal Brush
Ref. CL6220
When used carefully, it provides a more thorough cleaning.

Wiper

Ref. CL0160

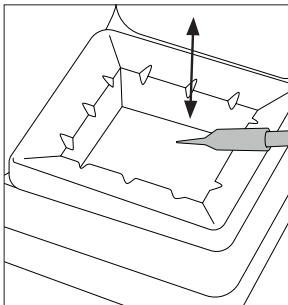

Tapping:
Tap gently to remove excess solder.

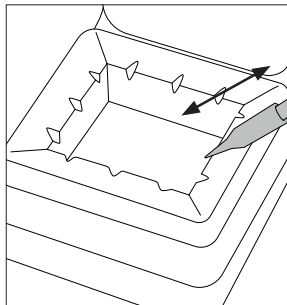

Wiping:
Use the slots to remove remaining particles.

Sponge

Ref. S0354

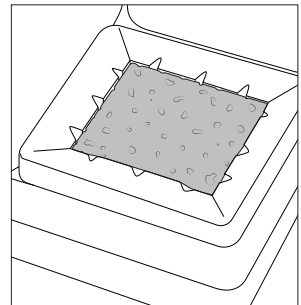

The least harmful cleaning method. Keep the sponge damp with distilled water when working to avoid tip wear.

Changing the Grips

Easily replace the **Grips for T245-A and T245-C** using the slip-on tabs (Ref. 0016057)

1. Inserting tabs

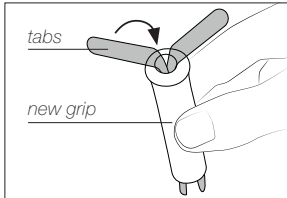

Put the slide-on tabs into the new grip.

2. Inserting handle

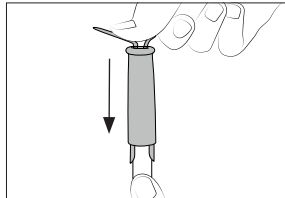

Push the grip with the tabs onto the handle.

3. Removing tabs

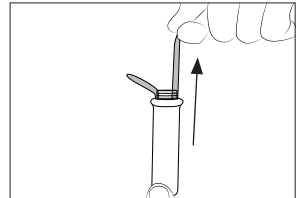

To remove the tabs, hold the grip and pull. Use a pliers if necessary.

Sealing Plug Replacement

The Sealing Plug is meant to prevent undesirable flux vapors or particles from entering inside the tool. Its usage is highly recommended for intensive applications when soldering in exposed to FOD environments or for applications where the soldering iron works close to vertical position.

 Before replacing the sealing plug, unplug the power supply and make sure the device is not hot.

1. Removing the Sealing Plug

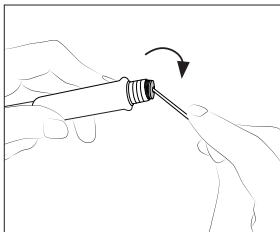

Enter a small shaft or screwdriver in order to gently lift and pull the Sealin Plug. Do not insert the tool more than 8 mm deep. Never use a cartridge to do this operation.

2. Mounting position

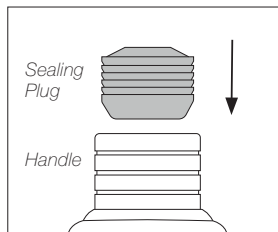

Note the Sealing Plug mounting position. The chamfered side has to be positioned towards the Handle.

3. Inserting the Sealing Plug

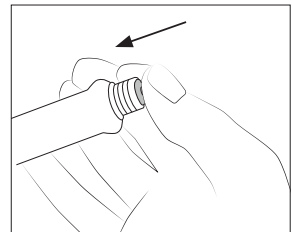

Gently push the Sealing Plug inside the handle until it is completely into the Handle. Handle and Sealing Plug edges have to be aligned.

Quick Tip Changer

Save time and change cartridges safely without switching the station off.

1. Removing

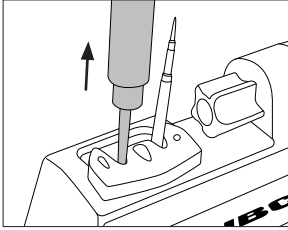

Place the handpiece in the extractor and pull to remove the cartridge.

2. Inserting

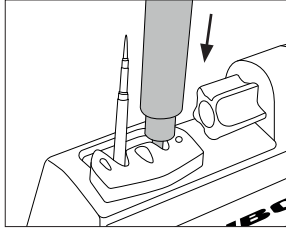

Place the handpiece on top of the new cartridge and press down slightly.

3. Fixing

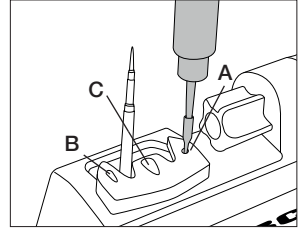

Use the holes for fixing the cartridge* as follows:
A. For straight C210.
B. For curved C210.
C. For C245.

*Important

It is necessary to insert the cartridges as far as the mark for a proper connection.



Compatible cartridges

The CD-S stations work with C210 cartridges and T210 handles.
 Find the model that best suits your soldering needs in www.jbctools.com

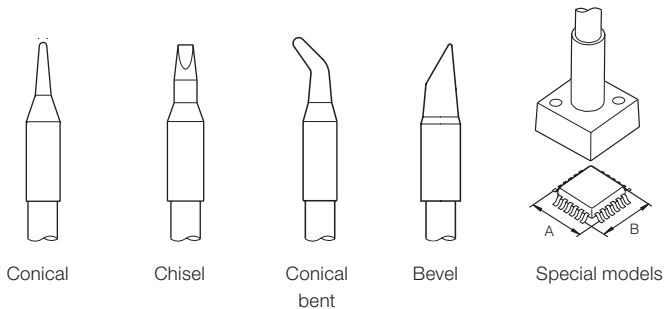

USB Connector

Download the latest software from our website to update your soldering station.

JBC Updater

www.jbctools.com/software.html

Update the station software via USB connection:

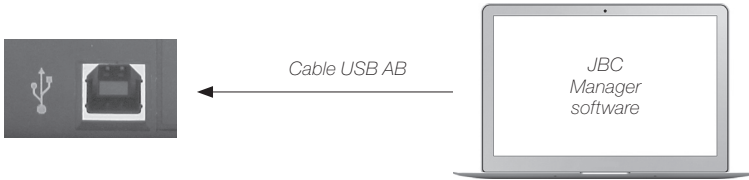

JBC Manager

www.jbctools.com/manager.html

Manage and monitor as many stations as your PC can handle by using the JBC Manager. You can export data to another PC.

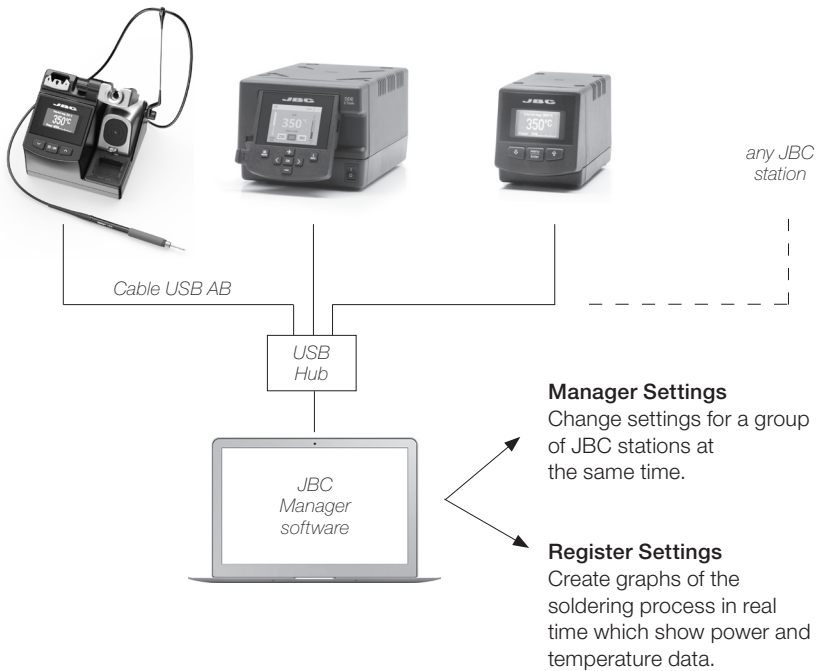

Operation

The JBC Most Efficient Soldering System

This revolutionary technology is able to recover tip temperature extremely quickly. This allows the user to work at a lower temperature. As a result, tip life increases by 5.

1. Work

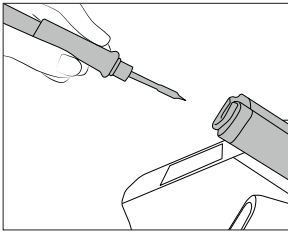

When the tool is lifted from the stand the tip will heat up to the selected temperature.

2. Sleep

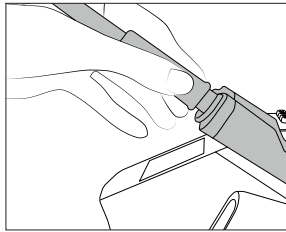

When the tool is in the stand, the temperature falls to the preset sleep temperature.

3. Hibernation

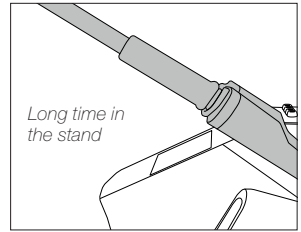

After longer periods of inactivity, the power is cut off and the tool cools down to room temperature.

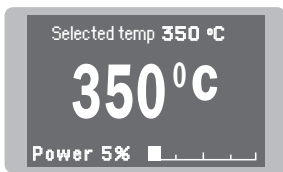

- Change temperature (from 90 to 450°C)
- Select temperature levels
- Fix one temperature



- Change Sleep temperature
- Set Sleep delay (from 0 to 9 min or no Sleep)

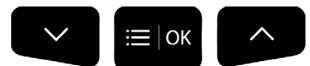

- Change Hibernation delay (from 0 to 35 min)

Control Process

Work Screen

The work screen provides useful information of tool status in real time.

Displays a specific fixed temp.

Shown when you have selected temp. levels. The values must be adjusted for the task.

"Temp. Adjust" parameter. It provides a more precise adjustment between the selected temp and the actual one.

Fixed temp. 350 °C

Levels °C 270 350 400

Selected temp. 350 °C

350 °C

-10

Power 5%

Navigation buttons: Down arrow, Menu/OK, Up arrow.

Menu Screen

Default PIN: 0105

Main menu

- Exit
- 1 Reset settings
- 2 Station settings
- 3 Tool settings
- 4 Counters
- 5 Program version

Station settings

- 1 Temp unit Celsius
- 2 Maximum temp 400°C
- 3 Minimum temp 200°C
- 4 Metronome ----
- 5 Help text OFF
- 6 Beep ON
- 7 Change PIN

Back

Tool settings

- 1 Fix one temp ----
- 2 Temp levels set OFF
- 3 Sleep delay 0 min
- Tool 210
- 4 Sleep temp 150°C
- 5 Hibernation delay 10 min
- 6 Temp adjust +0 °C

Back Tool 210

Counters

- 1 Plugged hours 0
- 2 Working hours 0
- 3 Sleep hours 0
- 4 Hibernation hours 0
- 5 No tool hours 0
- 6 Sleep cycles 0

Back

Troubleshooting

Station troubleshooting available on the product page at www.jbctools.com

Parameters

Be careful when using these parameters. They can reduce tip life if not used properly. Please follow the recommended guidelines:

Station Settings

Parameter description	Recommendations	Warnings
Temperature unit Celsius (°C) or Fahrenheit (°F)	N/a	
Maximum temperature Set the maximum temperature to work with. Max. temp by default is 400°C (750°F). This is considered high enough to work with most lead-free applications.	The station temperature range is 90-450°C (190-840°F). Change the temperature limits when working with less common applications such as low / high melting point soldering (HMP) or plastics (e. g. riveting).	<div style="background-color: #f0f0f0; padding: 10px;">  In most cases, working with temperatures over 400°C (750°F) can damage the PCB and its components. Even in short time periods of tip contact with the soldering joint, the flux may not work properly and could seriously reduce tip life. If the solder joint requires more power (e.g. multilayered or high dissipation boards), JBC strongly recommends using other aids like preheaters. </div>
Minimum temperature Set the minimum temperature to work with. Min. temp. by default is 200°C (392°F). This is considered to be a proper starting point for leaded applications.		
Metronome This activates a beep sound. Frequencies vary from 1 to 50 seconds.	Useful for setting a work rate in repetitive jobs. The beep lets you know the length of time the tip must be in contact with the soldering joint.	N/a
Help text Activate this parameter to receive info from the system.	N/a	N/a
Beep Enable/disable the beep sound of the keypad.	N/a	N/a
Change pin Change the default security PIN number (0105).	The PIN must be entered every time a parameter is changed.	N/a

Tool Settings

Parameter description	Recommendations	Warnings
Fix one temperature Fix a value within the temperature range of the station (90 - 450°C / 190 - 840°F).	Ideal for soldering more than one component at a specific temperature. The station will reject any attempt to change the temperature.	N/a
Temperature levels set Similar to “Fix one temp” parameter. In this case, the user can set up to 3 values for different power requirements.	This allows a quick change between 3 different temperatures. Set them according to the allowed values for your soldering applications.	N/a
Sleep delay Set the time that the tool will remain at the selected temperature when in the stand before entering sleep mode. The tip temperature will then drop to the Sleep temperature.	Because our tools reach the working temperature from the default Sleep mode in only a few seconds, this parameter is preset to 0 min. Once the tool is returned to the stand the temperature will automatically drop to the sleep temperature, extending tip life and avoiding oxidation. Retinning the tip before placing the tool in the stand will protect the tip and extend its life.	 Setting these parameters to higher values will unnecessarily accelerate oxidation and shorten tip life especially when working with temperatures up to 450°C (840°F).
Sleep temperature This is the set temperature the tip reaches when returned to the stand.	The sleep temperatures are set to achieve a balance between preventing oxidation and reaching the working temperature in a few seconds.	

Tool Settings

Parameter description**Recommendations****Warnings**

Hibernation Delay

Set the time the tool will remain at Sleep temperature before entering the Hibernation mode. At this time, the power supply is cut off and the tip remains at room temperature.

This function completely protects the tip from oxidation during long periods of inactivity while the tool is in the stand. Retinning the tip before placing the tool in the stand also helps prevent oxidation and extends the life of the tip.

 Increasing the default value will accelerate oxidation and shorten the tip life.

Temp Adjustment

It provides a more precise adjustment between the selected temperature and the actual one.

Set values within $\pm 50^{\circ}\text{C}$ ($\pm 90^{\circ}\text{F}$) to achieve zero error. JBC strongly recommends the use of TID-A or TIA-A Thermometers to obtain precise readings.

 When the user changes the cartridge type, the parameter should be reset to $0^{\circ}\text{C}/\text{F}$ or to the value needed for this cartridge. E.g. If a correction of $+20^{\circ}\text{C}$ ($+36^{\circ}\text{F}$) is set for the C245966 (thick type) and then the user changes the cartridge for a C245030 (which is thinner) without resetting, they would be working at a temperature of $+20^{\circ}\text{C}$ ($+36^{\circ}\text{F}$) lower for the C245030 which does not need any temperature adjustment.

Maintenance

Before carrying out maintenance, always allow the equipment to cool.

- Clean the station screen with a glass cleaner or a damp cloth.
- Use a damp cloth to clean the casing and the tool. Alcohol can only be used to clean the metal parts.
- Periodically check that the metal parts of the tool and stand are clean so that the station can detect the tool status.
- Maintain tip surface clean and tinned prior to storage in order to avoid tip oxidation. Rusty and dirty surfaces reduce heat transfer to the solder joint.
- Periodically check all cables and tubes.
- Replace a blown fuse as follows:

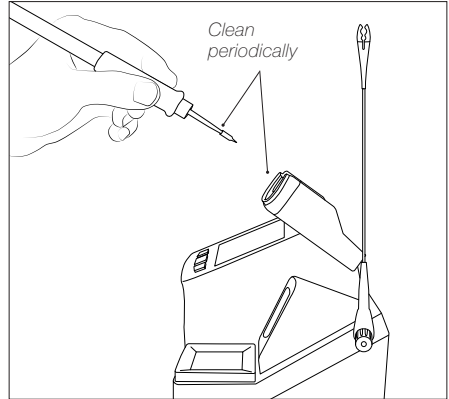

1. Pull off the fuse holder and remove the fuse. If necessary use a tool to lever it off.

2. Press the new fuse into the fuse holder and replace it in the station.

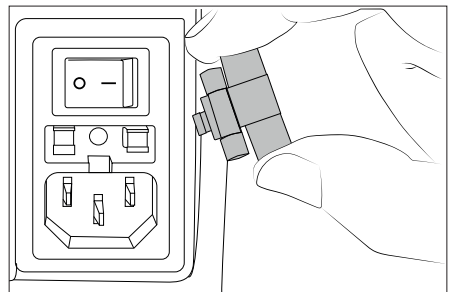
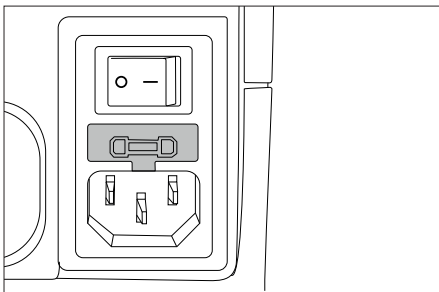

- Replace any defective or damaged pieces. Use original JBC spare parts only.
- Repairs should only be performed by a JBC authorized technical service.

Safety



It is imperative to follow safety guidelines to prevent electric shock, injury, fire or explosion.

- Do not use the units for any purpose other than soldering or rework. Incorrect use may cause fire.
- The power cord must be plugged into approved bases. Be sure that it is properly grounded before use. When unplugging it, hold the plug, not the wire.
- Do not work on electrically live parts.
- The tool should be placed in the stand when not in use in order to activate the sleep mode. The soldering tip, the metal part of the tool and the stand may still be hot even when the station is turned off. Handle with care, including when adjusting the stand position.
- Do not leave the appliance unattended when it is on.
- Do not cover the ventilation grills. Heat can cause inflammable products to ignite.
- Avoid the contact of flux with skin or eyes to prevent irritation.
- Be careful with the fumes produced when soldering.
- Keep your workplace clean and tidy. Wear appropriate protection glasses and gloves when working to avoid personal harm.
- Utmost care must be taken with liquid tin waste which can cause burns.
- This appliance can be used by children over the age of eight and also persons with reduced physical, sensory or mental capabilities or lack of experience provided that they have been given adequate supervision or instruction concerning use of the appliance and understand the hazards involved. Children must not play with the appliance.
- Maintenance must not be carried out by children unless supervised.

有害物质含量表

产品中有害物质的名称及含量

部件名称	有害物质					
	铅(Pb)	汞(Hg)	镉(Cd)	六价铬 (Cr(VI))	多溴联苯 (PBB)	多溴二苯醚 (PBDE)
烙铁头	○	○	○	○	○	○
手柄	○	○	○	○	○	○
电源线	○	○	○	○	○	○
主机	○	○	○	○	○	○
电源插座	○	○	○	○	○	○
保险丝	○	○	○	○	○	○
主开关	○	○	○	○	○	○
电位连接	X	○	○	○	○	○
变压器	○	○	○	○	○	○
线路板	X	○	○	○	○	○

○ 表示该有害物质在该部件所有均质材料中的含量均在GB/T 26572 规定的限量要求以下。
X 表示该有害物质至少在该部件的某一均质材料中的含量超出GB/T 26572 规定的限量要求。

Specifications

CD-1SQE 120V 50/60Hz. Input fuse: 2A. Output: 23,5V. Control Unit model: **CD-1E**
CD-2SQE 230V 50/60Hz. Input fuse: 1A. Output: 23,5V. Control Unit model: **CD-2E**
CD-9SQE 100V 50/60Hz. Input fuse: 2A. Output: 23,5V. Control Unit model: **CD-9E**

- Output Peak Power CD-SE: 40W
- Temperature Range: 90 - 450 °C (190 - 840 °F)
- Idle Temp. Stability (still air): $\pm 1.5^{\circ}\text{C}$ ($\pm 3^{\circ}\text{F}$) / Meets and exceed IPC J-STD-001
- Temp accuracy: $\pm 3\%$ (using reference cartridge)
- Temp adjustment: $\pm 50^{\circ}\text{C}$ ($\pm 90^{\circ}\text{F}$) Through station menu setting
- Tip to ground voltage: Meets and exceed
- Tip to ground resistance: ANSI/ESD S20.20-2014 IPC J-STD-001F
- USB connector station-PC
- Ambient operating temp: 10 - 50 °C (50 - 122 °F)
- Control Unit Weight: 2,67Kg (5.88 lb)
- Control Unit Dimensions: 150 x 175 x 145 mm (5.9 x 6.9 x 5.7 in)

- Total Package: 234 x 234 x 258 mm / 3.10 kg
9.2 x 9.2 x 10.2 in / 6.82 lb

Complies with CE standards
ESD protected housing "skin effect"

JBC

Warranty

JBC's 2 year warranty covers this equipment against all manufacturing defects, including the replacement of defective parts and labour.

Warranty does not cover product wear or misuse.

In order for the warranty to be valid, equipment must be returned, postage paid, to the dealer where it was purchased.

Get 1 extra year JBC warranty by registering here:
<https://www.jbctools.com/productregistration/>
within 30 days of purchase.



This product should not be thrown in the garbage.

In accordance with the European directive 2012/19/EU, electronic equipment at the end of its life must be collected and returned to an authorized recycling facility.

