

# JBC

[www.jbctools.com](http://www.jbctools.com)

## INSTRUCTION MANUAL



### **B-500 K**

Handle Expansion Kit for B-IRON

This manual corresponds to the following reference:

**B500-KA**

## Packing List

The following items are included:



**B-500  
Handle for B-IRON ....** 1 unit

*Cartridge not included, sold separately.*



**Left-Side Charging-Holder  
for B-IRON .....** 1 unit

*Cartridge not included, sold separately.*



**Manual .....** 1 unit  
Ref. 0033102

 Please read this manual and its safety guidelines thoroughly before using the product.

## Features

B-500 K allows to extend a B-IRON single station with an additional B-500 handle.

The provided B-500 performs up to 500 SMD soldering joints per charge.



*\* Not included, sold separately.*

## Connection Example

**PDS**  
Portable Display 7"  
for B-IRON \*

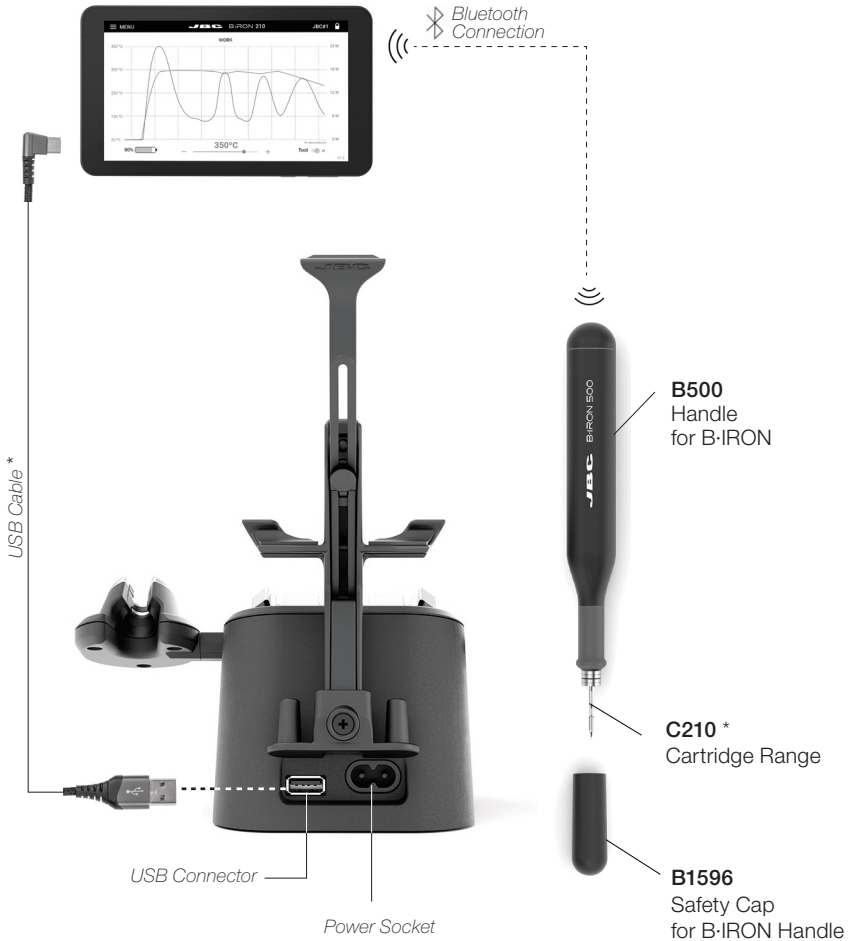

\* Not included, sold separately.

# Compatible Cartridges\*

B-500 works with C210 Cartridges. Find the model that best suits your soldering needs on [www.jbctools.com](http://www.jbctools.com)

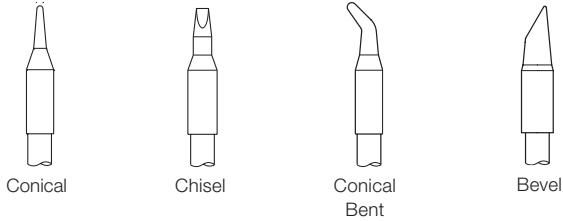

## Tool Charger Dissassembly and Replacement

Tool chargers can be disassembled by loosening the screws (1) at the bottom of the charging-base and pulling downward from the side band (2).

⚠ Before sliding down the side band, hold the tool charger with your hand to prevent it from falling down.

Then, to install a new tool charger onto the charging- base, place the tool charger at the top of the side rail and slide back the slide band over it until it is secured in place and tighten the screws at the base.

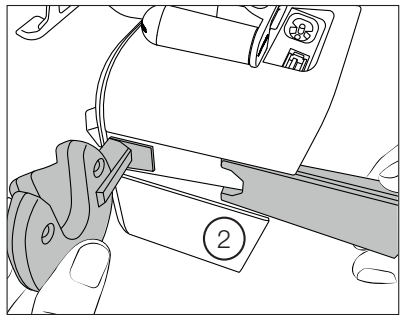
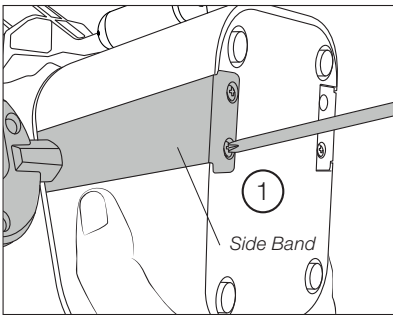

\* Not included, sold separately.

## Cartridge Insertion and Charging

### Inserting

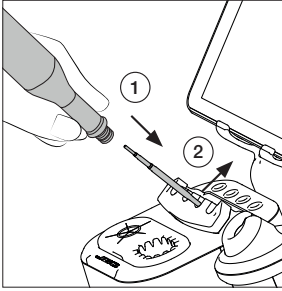

Place the tool over a cartridge and press the tool down to insert the cartridge (1). To release the tool with the cartridge from the extractor, lift the tool upward (2).

### Fixing

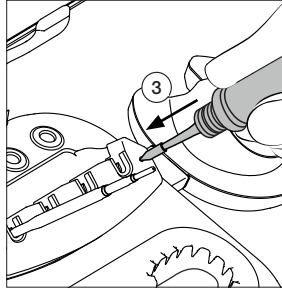

Make sure that the cartridge is appropriately inserted\* into the tool by gently pressing the tip against the holes on the sides of the cartridge exchanger (3).

**\*Important:** Cartridges must be inserted up to the mark for a proper connection.



### Charging

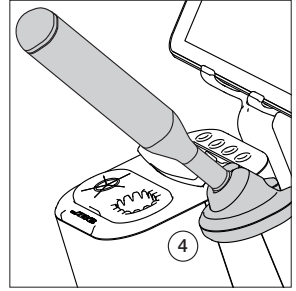

Place the tool in the charging holder (4) to charge it. A beep will sound to confirm that the tool is properly placed and charging. The sound can be turned up, down or off using the buttons on the display.

**⚠ Note:** Charge the tool completely before using it for the first time. A full charge takes:  
-30 min for B-100  
-60 min for B-500  
-30 min for B-NANO

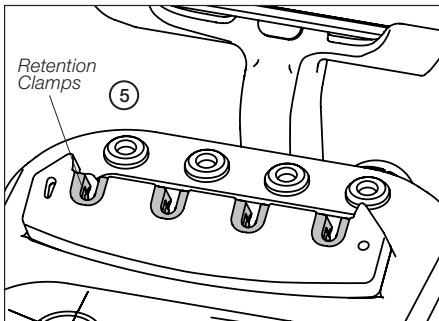

### Cartridge Retention

Cartridges are held in place inside the cartridge exchanger thanks to the retention clamps (5), with the advantage that the cartridges do not fall into the exchanger and the cartridge tips are therefore protected.

The cartridge exchanger of B-IRON stations works with C210 and C115 Cartridges.

### C210 Cartridge Retention Area

The holding area of C210 Cartridges goes from the collar of the tip until the cartridge begins to widen (x).



# Tool Selection

**Note:** The supplied handle is already connected.

Make sure that the charging base is connected to the mains.

### Scanning a new tool:

Place the tool in the charging holder to turn it on. The light color indicates the charge level (see table below).

If the scanning process does not run automatically, tap “scan” (6) on the display while the tool remains in the charging holder. When the tool is shown on the display, select it to be connected (7) and start working with it.

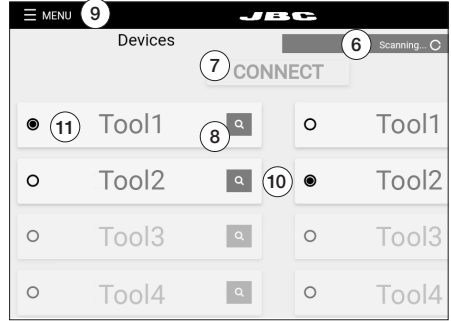

### Locate Tool (Search Function):

When in doubt of which tool corresponds to the tool's name, use the Locate Tool function.

Tap on the magnifying glass symbol (8) next to the tool's name. The light band on the corresponding tool blinks in blue for five seconds to identify it.

### Working with two tools (works also for charging bases with only one charging holder):

It is possible to connect up to two tools at the same time. If a tool is already connected, first select “Menu” (9) and tap on “Disconnect” to disconnect it from the device.

Place the second tool in the charging holder and scan it (6). The second tool is also shown on the display (10). To work with two tools, select one from the left-hand column (11) and the other one from the right-hand column (10). Then tap on “CONNECT” (7).

# Status Lightband

The status lightband on the tool indicates its status (see table on the right).

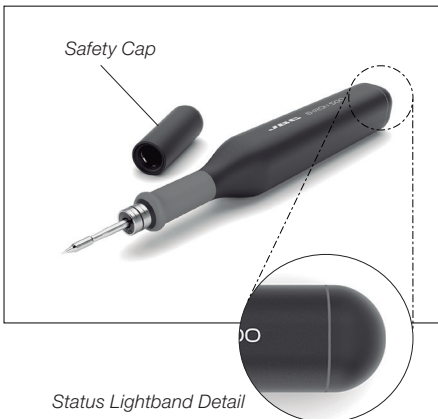

Color	Tool Status
Green	More than 50% charged
Orange	Between 20% and 50% charged
Red	Less than 20% charged
Green blinking	Charging (more than 50% charged)
Orange blinking	Charging (between 20% and 50% charged)
Red blinking	Charging (less than 20% charged)
No color	Safety cap on the handle and/or power off
Blue blinking	Locate Tool function activated

## Safety Cap

Thanks to their safety cap, B-IRON handles can be transported safely, even with the cartridge inserted.

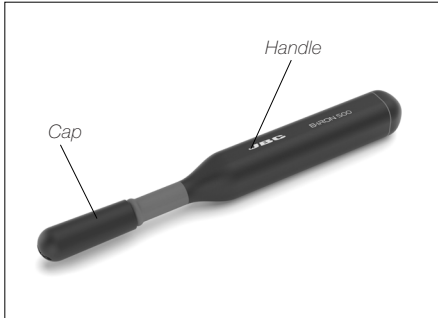

When the cap is placed onto the handle, the cartridge stops heating immediately, data transfer is cut off and the handle is disconnected from the station.

The handle turns off completely after 10 minutes without any movement, resulting in lower battery consumption.

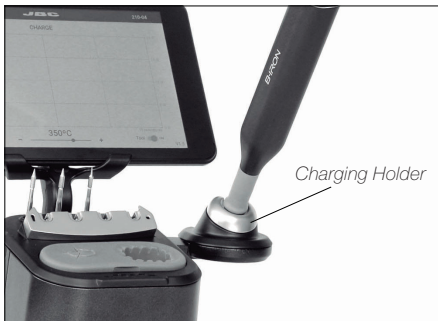

To reactivate and switch on the handle, the cap must be removed and the handle inserted in the charging holder so that the station recognizes the handle.

**Note:** The charging base must be connected to the mains to activate the tool.

## Cap Holder

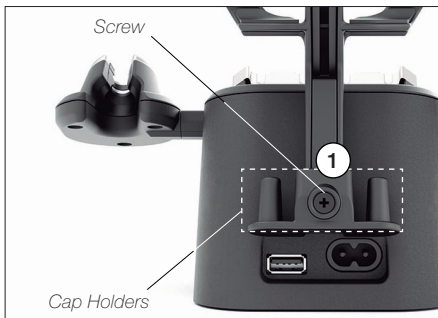

While the handle is in use, the cap can be stored on the cap holder located on the back of the charging base. There is space for two caps.

If desired, the cap holder can be detached by removing the screw (1).

# Operation

## JBC's Most Efficient Soldering System

This revolutionary technology recovers tip temperature extremely quickly. This allows the user to work at a lower temperature.

### Work

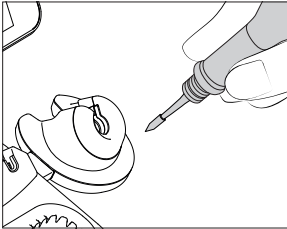

When the tool is lifted from the tool holder, the tip of the assembled cartridge heats up to the selected working temperature.

### Charge Mode

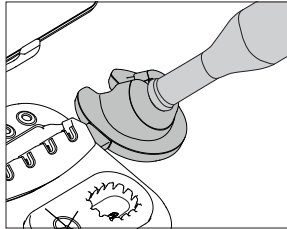

While the tool remains in the tool holder, it charges and the tip gradually cools down to room temperature.

### Sleep Mode

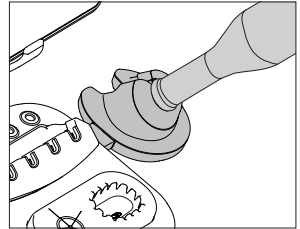

If Sleep Mode is activated (see section "Settings"), upon placing the tool in its holder, besides charging it enters Sleep Mode. The tip temperature drops down and remains at Sleep temperature.

### Hibernation Mode

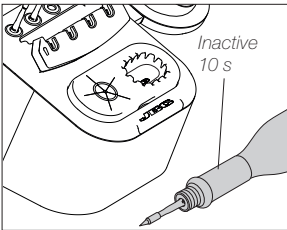

When the tool is away from the tool holder and remains inactive (no movement for at least 10 seconds), it goes into Hibernation Mode and the tip temperature gradually cools down to room temperature.

### Automatic Turn Off

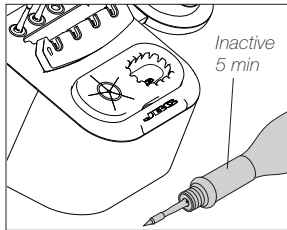

If the tool has been inactive for a longer period of time (at least 5 minutes), it automatically turns off.

### Turning the Tool Back On

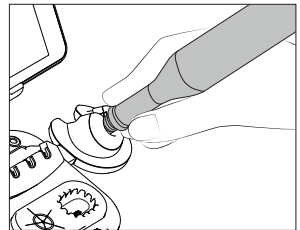

After automatically turning off, put the tool back in the holder to turn it on again.

**Note:** The tool can also be switched off/on manually. Tap the *Tool* power switch on the display (bottom right) to switch it off/on (if the tool is turned off, it will remain connected up to 5 minutes to the station but will not heat up the cartridge).

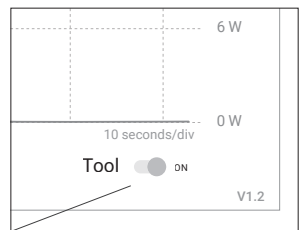

Tool Power Switch



## Replacing B1510 Grips (Soft Foam)

### Inserting Fitters

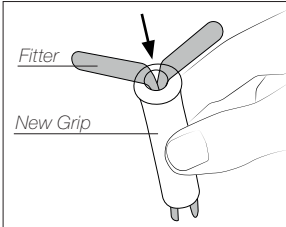

Insert the fitters into the new grip.

### Assembling Grips

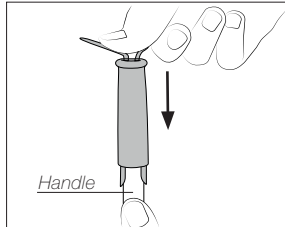

Push the grip with the fitters onto the handle.

### Removing Fitters

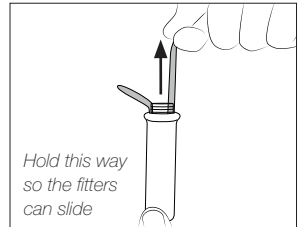

To remove the fitters, hold the grip and pull the fitters out. Use pliers if necessary.

## Replacing Sealing Plugs

The sealing plug prevents undesirable flux vapors or particles from entering the handle. Its usage is highly recommended for intensive applications when soldering is exposed to FOD environments or for applications where the soldering iron works close to a vertical position.

**Note:** Choose between the two available sealing plug references depending on your handle model.

⚠ Before replacing the sealing plug, disconnect the handle from the station and make sure the device is not hot.

Handle	Sealing Plug
B-100	OB4000
B-500	
B-NANO	OB5000

### Removing Sealing Plug

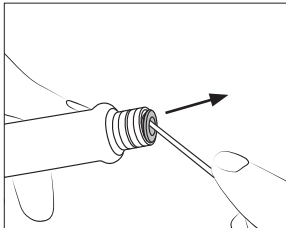

Introduce a small shaft or screwdriver, not deeper than 8 mm, lift and pull the sealing plug. Never use a cartridge to do this operation.

### Mounting Position

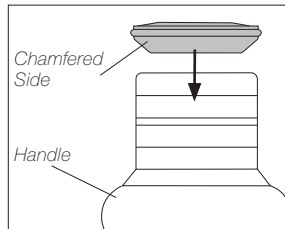

**Note:** The chamfered side has to be positioned towards the handle.

### Inserting Sealing Plug

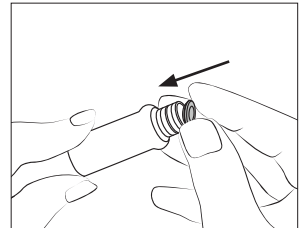

Push the sealing plug inside the handle until the sealing plug and handle edges are aligned.

# B-IRON Tool Firmware Updating

Tool firmware updates are not executed automatically; they must be carried out by the user.

## Tool updating through JBC display (Android)

**Note:** The display must be connected via USB cable to a PC with internet connection.

1. On your PC, go to “<https://www.jbctools.com/software.html>.” Tap on “Station Firmware Update”, then tap on the latest version displayed for B-IRON to download the update zip file.

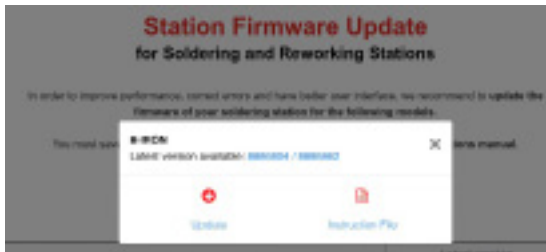

2. On the JBC display, check if there is a folder in the internal storage named “Internal shared storage\Android\data\es.infinitysource.jbc\_soldering.JBCBiron\files”. If it does not exist, create it.
3. Unzip and copy the update files from the PC to JBC’s display into the above-mentioned folder.
4. Access the B-IRON app and select the tool you want to update. Then tap on “Menu” and select “Update”.
- 5.1. If an update file with a newer version (1) than the one already installed is displayed, tap “Update” (2) to start the update. Once the update is completed, “Tool updated” (3) will be displayed.
- 5.2. If “No new version available” is displayed (4), no update is possible nor required.

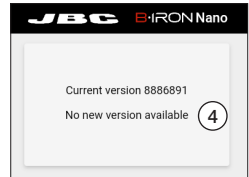
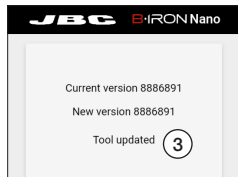
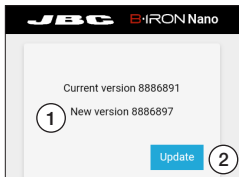

## B-IRON Tool Firmware Updating

### Tool updating through user's smartphone or tablet (Android/iOS)

**Note:** Your device must be connected to the internet.

1. On your device, go to "https://www.jbctools.com/software.html." and tap on "Station Firmware Update", then tap on the latest version displayed for the B-IRON to download the update zip file.
2. Go to the internal file storage of your device and extract the update files from the zip folder.
  - 3.1. For Android devices, copy the update files into the folder:  
"Internal shared storage\Android\data\com.jbctools.jbciron\files".
  - 3.2. For iOS devices, copy the update files into the B-IRON app folder:

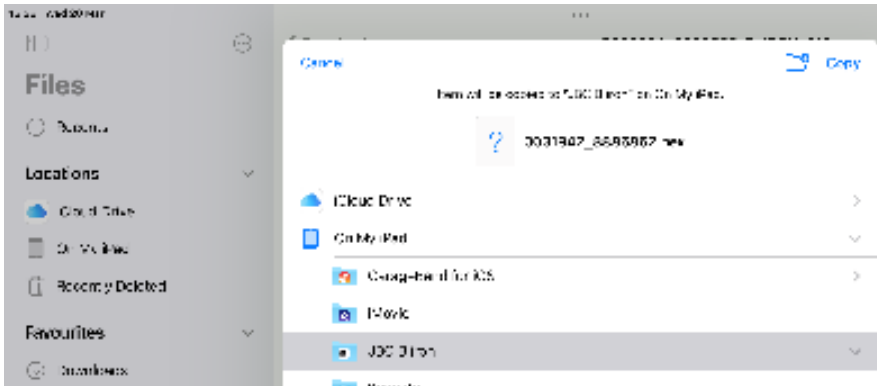

Complete the update by following steps 4 and 5 from the previous section.

## Maintenance

Before carrying out maintenance, always extract the cartridge from the tool and disconnect the charging stand from the mains. Allow the equipment to cool down.

- Use a damp cloth to clean the casing and the tool. Alcohol can only be used to clean the metal parts.
- Periodically check that the metal parts of the tool and tool charger are clean so that the charging works properly.
- Keep the tip surface clean and tinned prior to storage in order to avoid tip oxidation. Rusty and dirty surfaces reduce heat transfer to the solder joint.
- Do not use liquids such as alcohol, thinner or benzene to clean the tablet.
- Repairs should only be performed by a JBC authorized technical service.



## Safety - Battery



**It is imperative to follow safety guidelines to prevent electric shock, injury, fire or explosion.**

- **Caution:** This product contains lithium-ion batteries. Mishandling or improper use may result in fire, explosion, or personal injury.
- Always use the provided charger. Do not use damaged chargers or batteries.
- Never attempt to disassemble or modify the batteries or the product. Doing so may lead to electric shock, fire, or damage to the product.
- In the event of damage, leakage, or overheating of the batteries, discontinue use immediately and contact customer support or JBC technical service facility.
- Dispose of devices with batteries inside, responsibly according to regulations. They must be disposed of in accordance with local regulations so that they can be recycled.
- Do not throw devices with batteries into household waste and do not dispose of them in fire or water.

## Safety



**It is imperative to follow safety guidelines to prevent electric shock, injury, fire or explosion.**

- Do not use the units for any purpose other than soldering or rework. Incorrect use may cause a fire.
- The power cord must be plugged into approved bases. When unplugging it, hold the plug, not the wire.
- Do not attempt to dismantle or open the housing of the tool as it may cause damage.
- Do not work on electrically live parts.
- The tool should be placed in the charging holder when not in use in order to charge the batteries.
- The soldering tip, the metal part of the tool and the charging holder may still be hot even when the station is turned off.
- Do not leave the tool unattended when it is on.
- Avoid flux coming into contact with skin or eyes to prevent irritation.
- Be careful with the fumes produced when soldering.
- Keep your workplace clean and tidy. Wear appropriate protection glasses and gloves when working to avoid personal harm.
- Utmost care must be taken with liquid tin waste, which can cause burns.
- This appliance can be used by children over the age of eight and also persons with reduced physical, sensory or mental capabilities or lack of experience provided that they have been given adequate supervision or instruction concerning the use of the appliance and understand the hazards involved. Children must not play with the appliance.
- Maintenance must not be carried out by children unless supervised.
- Do not expose the portable display to high temperatures, humidity or dust. Avoid direct sunlight.
- Do not drop the portable display or the tool, as it may cause damage or malfunction.
- Do not disconnect your device when it is in file transfer mode.
- Do not use the portable display in places where wireless communications are restricted.





# Specifications

## B-500 K

### Handle Expansion Kit for B-IRON

Ref.: B500-KA

#### B-500 Handle

- |                                     |                                 |
|-------------------------------------|---------------------------------|
| - Peak Power (Tool):                | 24 W                            |
| - Battery:                          | Li-Ion 7.4 V / 750 mAh          |
| - Charge Time:                      | 60 minutes                      |
| - Selectable Temperature:           | 100 - 450 °C / 210 - 840 °F     |
| - Idle Temp. Stability (still air): | ±1.5 °C / ±3 °F                 |
| - Temp. Accuracy:                   | ±3% (Using reference cartridge) |
| - Connections:                      | Bluetooth Low Energy (BLE)      |
| - Ambient Operating Temp:           | 10 - 50 °C / 50 - 122 °F        |
| - Tool Weight (without cap):        | 70 g / 0.154 lb                 |

#### B-500 K

- |   |   |
|---|---|
| - Total Net Weight:                               | 162 g / 0.357 lb  |
| - Total Package Dimensions/Weight:<br>(L x W x H) | 245 x 185 x 45 mm / 321 g<br>9.65 x 7.28 x 1.77 in / 0.708 lb |

Complies with CE standards.

Not grounded device. No ESD discharge feature.

# JBC

## Warranty

JBC's 2 year warranty covers this equipment against all manufacturing defects, including the replacement of defective parts and labour.

Warranty does not cover product wear or misuse.

In order for the warranty to be valid, equipment must be returned, postage paid, to the dealer where it was purchased.



This product should not be thrown in the garbage.

In accordance with the European directive 2012/19/EU, electronic equipment at the end of its life must be collected and returned to an authorized recycling facility.



[www.jbctools.com](http://www.jbctools.com)

0033102-180424